

V7 and V74X Drives Technical Manual

*This Manual
also available on
www.drives.com*



QUICK REFERENCE – – DRIVE PARAMETERS

PARAMETERS	FACTORY SETTING	USER SETTING
n001	1	
n002	0	
n003	1	
n004	2	
n005	0	
n006	0	
n007	0	
n008	0	
n009	0	
n010	0	
n011	60	
n012	230/460	
n013	60	
n014	Note 2	
n015	Note 2	
n016	Note 2	
n017	Note 2	
n018	0	
n019	10.0	
n020		
n021		
n022		
n023	0	
n024	6.00	
n025	0.00	
n026	0.00	
n027	0.00	
n028	0.00	
n029	0.00	
n030	0.00	
n031	0.00	
n032	6.00	
n033	100	
n034	0	
n035	0	
n036	Note 1	
n037	0	
n038	8	
n039	0	
n040	0	
n041	10.0	
n042		
n043		
n044		
n050	1 (1)	
n051	2 (2)	
n052	3 (0)	
n053	5 (5)	
n054	6 (6)	
n055	7 (7)	
n056	10 (10)	
n057	0	
n058	1	
n059	2	
n060	100	

PARAMETERS	FACTORY SETTING	USER SETTING
n061	0	
n062	0.10	
n064	0	
n065	0	
n066	0	
n067	1.00	
n068	100	
n069	0	
n070	0.10	
n071	100	
n072	0	
n073	0.10	
n074	100	
n075	0	
n076	0.10	
n077	0	
n078	0	
n079	10	
n080	3	
n081	0	
n082	0	
n083	0.00	
n084	0.00	
n085	0.00	
n086	0.00	
n089	50	
n090	0.5	
n091	0.0	
n092	0	
n093	170	
n094	160	
n095	0.00	
n096	0	
n097	0	
n098	160	
n099	0.1	
n100	0	
n101	2	
n102	150	
n103	1.0	
n104	Note 2	
n105	Note 1	
n106	Note 1	
n107	Note 1	
n108	Note 1	
n109	150	
n110	Note 1	
n111	Note 2	
n112	Note 2	
n113	0	
n115	0	
n116	0	
n117	0	
n118	0	
n119	0.1	

PARAMETERS	FACTORY SETTING	USER SETTING
n120	0.00	
n121	0.00	
n122	0.00	
n123	0.00	
n124	0.00	
n125	0.00	
n126	0.00	
n127	0.00	
n128	0	
n129	1.00	
n130	1.0	
n131	1.0	
n132	0.00	
n133	0	
n134	100	
n135	0.0	
n136	0	
n137	0	
n138	1.0	
n139	0	
n140	Note 1	
n141	50	
n142	12	
n143	1 (24 ms)	
n144	0%	
n145	0.5%	
n146	0.2%	
n149	3072 (30, 720 Hz)	
n150	0	
n151	0	
n152	0	
n153	0	
n154	2	
n155	2	
n156	10	
n157	0	
n158	Note 1	
n159	120	
n160	16	
n161	10	
n162	5 (20 ms)	
n163	1.0	
n164	0	
n166	0	
n167	0	
n168	0	
n169	0.0	
n173	83 (0.083)	
n174	25 (100 ms)	
n175	0	
n176	rdy	
n177	0	
n178	N/A	
n179	0024	N/A

Note 1: Factory setting differs depending on the Drive capacity. See Appendix 3-1.

Note 2: Factory setting differs depending on control method selected (**n002**). See Appendix 3-1.

CONTENTS

PARAGRAPH

SUBJECT

PAGE

	QUICK REFERENCE FOR DRIVE PARAMETERS	Inside Cover
	WARNINGS & CAUTIONS	iii
	DRIVE SIMPLIFIED STARTUP PROCEDURE	v
	CURRENT RATINGS AND HORSEPOWER RANGE	xv
1	RECEIVING / INSTALLATION	1-1
1.1	General	1-1
1.2	Receiving	1-1
1.3	Physical Installation	1-1
1.4	Electrical Installation	1-6
2	INITIAL START-UP	2-1
2.1	Pre-Power Checks	2-1
2.2	Open Loop Vector Startup	2-2
2.3	V/f Startup Procedure	2-6
3	OPERATION AT LOAD	3-1
4	DIGITAL OPERATOR	4-1
4.1	General	4-1
4.2	Digital Operator	4-1
4.3	Status Indicator LEDs	4-3
4.4	Monitor Displays	4-3
5	PROGRAMMABLE FEATURES	5-1
5.1	General	5-1
5.2	Accel/Decel Time	5-2
5.3	Accel/Decel: S-Curve Characteristics	5-3
5.4	Auto-Restart	5-4
5.5	Carrier Frequency	5-5
5.6	Critical Frequency Rejection	5-6
5.7	DC Injection Braking	5-7
5.8	Frequency Reference Bias/Gain (Analog)	5-8
5.9	Frequency Reference Upper and Lower Limits	5-9
5.10	Frequency Reference Retention	5-9
5.11	Frequency Reference Selection	5-10
5.12	Jog Reference	5-13
5.13	Local/Remote Reference and Sequence Selection	5-14
5.14	Modbus Control	5-16
5.15	Miscellaneous Protective Functions	5-20
5.16	Momentary Power Loss Ride-Thru	5-20
5.17	Multi-Function Analog Monitor Output (Term. AM and AC)	5-20
5.18	Multi-Function Input Terminals (Term. S1-S7)	5-22
5.19	Multi-Function Output Terminals (Term. MA, MB, MC, P1, P2, PC) ...	5-28
5.20	Overtorque Detection	5-31

CONTENTS – Continued

PARAGRAPH	SUBJECT	PAGE
5.21	Reset Codes: 2-Wire, 3-Wire Initialization	5-32
5.22	Slip Compensation	5-33
5.23	Stall Prevention	5-34
5.24	Stopping Method	5-35
5.25	Thermal Overload Protection	5-36
5.26	Torque Compensation	5-37
5.27	V/f Pattern	5-38
5.28	PID Control	5-42
5.29	Copy Function	5-46
5.30	Digital Operator Display Selection	5-52
5.31	Energy Saving Control	5-53
5.32	Multi-Function Analog Input Selection	5-55
5.33	Frequency Reference Loss Detection	5-57
5.34	Undertorque Detection	5-58
6	FAULT DIAGNOSIS AND CORRECTIVE ACTIONS	6-1
6.1	General	6-1
6.2	Displaying Fault Sequence	6-8
Appendix 1	PARAMETER LISTING	A1-1
Appendix 2	SPECIFICATIONS	A2-1
Appendix 3	CAPACITY AND CONTROL METHOD RELATED PARAMETERS	A3-1
Appendix 4	PERIPHERAL DEVICES	A4-1
Appendix 5	DRIVE DIMENSIONS	A5-1
	NEMA 1	A5-1
	NEMA 4x/12	A5-4
Appendix 6	DYNAMIC BRAKING OPTION	A6-1
Appendix 7	NAMEPLATE INFORMATION	A7-1
Appendix 8	REMOVE/INSTALL DRIVE FACE PLATES	A8-1
	NEMA 1	A8-1
	NEMA 4x/12	A8-3
Index	I-1

WARNINGS, CAUTIONS, INSTRUCTIONS

WARNING

YASKAWA manufactures component parts that can be used in a wide variety of industrial applications. The selection and application of YASKAWA products remain the responsibility of the equipment designer or end user. YASKAWA accepts no responsibility for the way its products are incorporated into the final system design. Under no circumstances should any YASKAWA product be incorporated into any product or design as the exclusive or sole safety control. Without exception, all controls should be designed to detect faults dynamically and fail safely under all circumstances. All products designed to incorporate a component part manufactured by YASKAWA must be supplied to the end user with appropriate warnings and instructions as to that part's safe use and operation. Any warnings provided by YASKAWA must be promptly provided to the end user. YASKAWA offers an express warranty only as to the quality of its products in conforming to standards and specifications published in the YASKAWA manual. **NO OTHER WARRANTY, EXPRESS OR IMPLIED, IS OFFERED.** YASKAWA assumes no liability for any personal injury, property damage, losses, or claims arising from misapplication of its products.

WARNING

- Do not connect or disconnect wiring while the power is on. Do not remove covers or touch circuit boards while the power is on.
- Before servicing, disconnect all power to the equipment. The internal capacitor remains charged even after the power supply is turned OFF. Status indicator LEDs and Digital Operator display will be extinguished when the DC bus voltage is below 50 VDC. To prevent electric shock, wait at least 1 minute after all indicators are OFF.
- Do not perform a withstand voltage test on any part of the unit. This equipment uses sensitive devices and may be damaged by high voltage.
- The drive is not suitable for circuits capable of delivering more than 18000 RMS symmetrical amperes at 250V maximum or 480V maximum. Install adequate branch short circuit protection. Refer to appendix. Failure to do so may result in equipment damage and/or personal injury.

WARNING

- Input Fuses are required for proper branch short circuit protection for all NEMA type 4X/12 drives. Failure to use recommended fuses (See Appendix 4) may result in damage to the drive and/or personal injury.

CAUTION

The Drive leaves the factory with parameters initialized for 2-Wire control (when using external Run/Stop signals). Before using the initialization function of constant n001, know your control wiring configuration:

10 = Factory 2-Wire Control Initialization (Maintained RUN Contact)

11 = Factory 3-Wire Control Initialization (Momentary START/STOP Contact)

Entering either Initialization code resets all parameters to factory settings, and automatically returns parameter n001 setting to " 1 ". If the Drive is connected for 3-Wire control and this parameter is set to " 10 " (2-Wire Control Initialization), the motor may run in reverse direction WITHOUT A RUN COMMAND APPLIED. Equipment damage or personal injury may result.

Parameter n012 must be set to proper motor voltage.

Always ground the Drive using the ground terminal provided.

Never connect main circuit output terminals T1 (U), T2 (V) & T3 (W) to AC main circuit power supply.

When programmed for auto-restart (n082 = " 1 " thru " 10 "), the motor may restart unexpectedly — personal injury may result

For Enclosed wall-mounted type (NEMA type 1)

When mounting units in an enclosure, remove the top, bottom and terminal covers. Install a cooling fan or some other means to maintain the air entering the enclosure below 113°F (45°C).

For Water and dust tight type (NEMA type 4X/12)

Never submerge this model in water. For the cable lead-in section, use a waterproof cable gland. After completion of wiring, mount the front cover and bottom cover with care so as not to damage the gasket. The front cover mounting screws and bottom cover mounting screws are made of stainless. Replacements must be of stainless steel and the same length.

IMPORTANT

- Wiring should be performed only by qualified personnel.
- Verify that the rated voltage of the drive matches the voltage of the incoming power.
- Some drawings in this manual are shown with the protective covers and shields removed, in order to describe detail with more clarity. Make sure all covers and shields are replaced before operating this product.
- This manual may be modified when necessary because of product improvement, modification, or changes in specifications.
- YASKAWA is not responsible for any modification of the product made by the user, doing so will void the warranty.

SIMPLIFIED STARTUP PROCEDURE

This procedure is a simplified step by step guide to installing, programming, and using the Yaskawa V7 & V74X (hereafter referred to as the Drive). It highlights several common installation configurations. Detailed information on all drive features can be found in Technical Manual.

- ❑ **Check Nameplate** - Be certain your input voltage source, motor and drive nameplates are all marked either 230V or 460V. Other voltages can be used, but require additional programming; see paragraph 5.27, V/f pattern.
- ❑ **Mount drive** - on a vertical surface with adequate space for air circulation (4.7" above and below, 1.2" on each side).
- ❑ **Remove front cover** - fit conduit to bottom plate, and connect power and ground wires as shown.

⚠ CAUTION

BE CERTAIN YOU CONNECT INPUT POWER TO TERMINALS L1, L2, AND L3 ONLY, OR SERIOUS DAMAGE WILL RESULT. CONNECT MOTOR TO TERMINALS T1, T2, AND T3 ONLY.

POWER WIRING SCHEMATIC

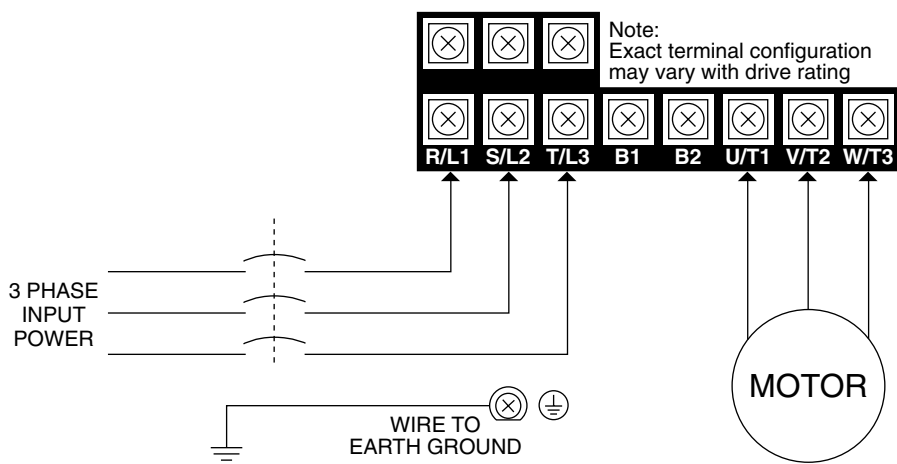

- ❑ **Replace cover and apply input power** – digital operator shows “0.00”; The FREF LED is on and the RUN LED is flashing. Press the **DSPL** key until the LO/RE LED is on. Press the **UP ARROW** button until the display shows “Lo,” then press the **DSPL** button until the FREF LED is on. Rotate the potentiometer on the front of the digital operator until the display shows “6.00.” Press the **RUN** button and note the direction of motor rotation. If rotation is incorrect, remove power, wait for the display lights to go out, then switch wires between terminals T1 and T2. Replace the front cover and apply input power.

❑ **Digital Operator**

The **DSPL** button cycles through all of the quick start LEDs.

To access a parameter, press the **DSPL** button until the PRGM LED is on. Use the **UP** and **DOWN** keys until the desired parameter number is displayed, then press **ENTER**. Use the **UP** and **DOWN** keys to adjust the value then press **ENTER** then **DSPL**.

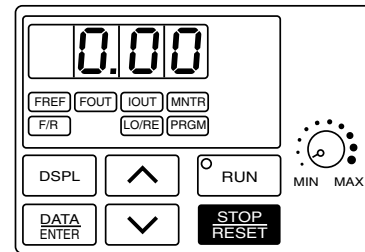

Before the drive will accept a RUN command, one of the following LEDs must be on: FREF, FOUT, IOUT, MNTR, or F/R. For more specific information on the digital operator, see Section 4.

- ❑ **Choose a configuration from Table 1 below.** Each example listed below contains a control wiring diagram, operation explanation, and all necessary programming. *The Drive can be controlled in many more ways than is described in these examples, see Paragraph 5.11, Frequency Reference Selection, and Paragraph 5.13, Local/Remote Reference and Sequence Selection.*

Table 1: Drive Configuration Examples

Sequence* Source (Run / Stop)	Reference* Source (Motor Speed)	Description	Example
Digital Operator	Digital Operator	This method requires no control wiring connections to the drive. It is most often used during startup of the drive.	Example 1
2-wire	Digital Operator	With this method, the drive can be started and stopped using an external (remote) signal.	Example 2
3-wire	Digital Operator	This method is the same as Example 2 above, but uses pushbuttons instead.	Example 3
2-wire	4-20 mA	This method is the same as Example 2, but the reference comes from a remote 4 – 20 mA source such as a PLC.	Example 4
3-wire	Remote Speed Potentiometer	This method is similar to Example 3, but utilizes a remote mounted speed control (potentiometer).	Example 5
2-wire	0 – 10V DC with several digital presets	This method is similar to 2, but allows switching between an analog reference and three digital preset references.	Example 6

* For a more detailed explanation of sequence and reference, consult the Definitions Section.

- ❑ **Control Terminal Wiring** – Remove power and wait for all LEDs to go out before making control terminal connections. Control wiring should be sized 16 to 20 AWG. Control wiring should be shielded, with the shield wire connected to the ground terminal, which is located towards the left side of the aluminum heat sink.

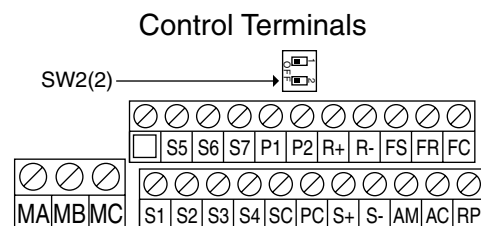

- ❑ **Control Method** – This document assumes that the drive will be left in the volts per hertz (V/f) control method. For a further explanation of control method or to change the control method, consult Section 2.1.

Example 1: Sequence & Reference Are Local (Digital Operator)

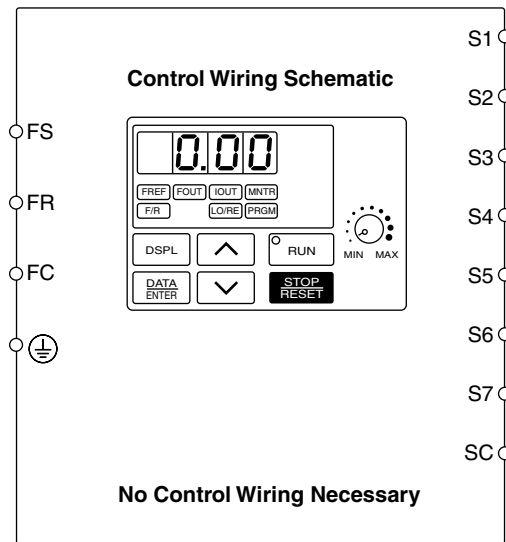

When the drive is set up with the sequence and the reference coming from the digital operator, it is in “Local” control. Local control is often used during startup to verify motor operation, rotation, etc. The drive can be temporarily placed in “Local” control simply by using the LO/RE quick start LED. If power is removed and then restored, the drive will come up in the “Remote” mode.

The drive can be programmed so that even if power is lost, the drive will come up in the local mode (see Table 2 below).

OPERATION:

- The frequency reference comes from the digital operator pot.
- The drive can be started by pressing the **RUN** key on the digital operator.
- The drive can be stopped by pressing the **STOP** key on the digital operator.
- The direction of the motor can be changed regardless of motor speed by using F/R quick start LED.

Table 2: Programming required for “Local” mode

Parameter	Display	Description
n001	4	Changing this parameter will allow access to all parameters.
n003	0	This parameter sets the sequence (start/stop) to "Local" mode.
n004	0	This parameter sets the reference (motor speed) to come from the digital operator potentiometer (local).
n036	Set Motor F.L.A.	Enter the motor's full load amps (as shown on the motor nameplate).
Quick Start LED	F/R	Motor direction can be changed regardless of motor speed using this quick start LED.

Example 2: Remote Sequence (2-Wire) & Local Reference (Digital Operator)

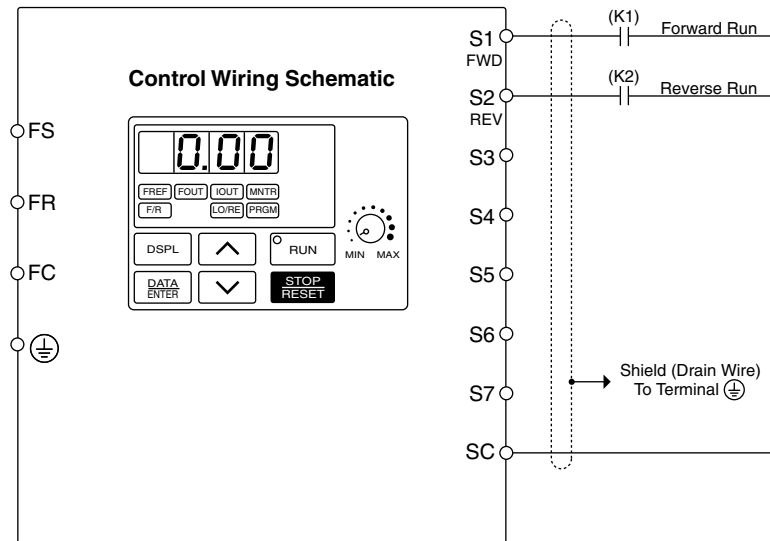

This configuration is used when the sequence comes from a remote source, such as a relay or a PLC. It can also be used with a maintained switch when it is desirable to have the drive restart on restoration of power. It should not be used where safety of attending personnel might be threatened by a restart.

OPERATION:

- The frequency reference comes from the digital operator pot.
- Close (K1) to Run Forward at frequency set by the digital operator pot.
- Close (K2) to Run Reverse at frequency set by the digital operator pot.
- If both (K1) & (K2) are closed, the drive stops and displays the error message: “EF”
- If the drive is put in the “Local” mode using the LO/RE quick start LED, the drive will behave the same as illustrated in Example 1.

Table 3: Programming Required For Remote 2-wire Sequence & Local Reference

Parameter	Display	Description
n001	10	The drive will perform a 2-wire reset. CAUTION Setting this value will reset all parameters to their original factory settings (all previous adjustments will be lost) <i>When the drive completes the reset, this parameter returns to a value of 1.</i>
n001	4	After doing the reset above, the password parameter returned to a 1. Change it to a 4 to get access to all parameters in the drive.
n004	0	This parameter sets the reference (motor speed) to come from the digital operator potentiometer (local).
n036	Set Motor FLA	Enter the motor's full load amps (as shown on the motor nameplate).

Example 3: Remote Sequence (3-Wire) & Local Reference (Digital Operator)

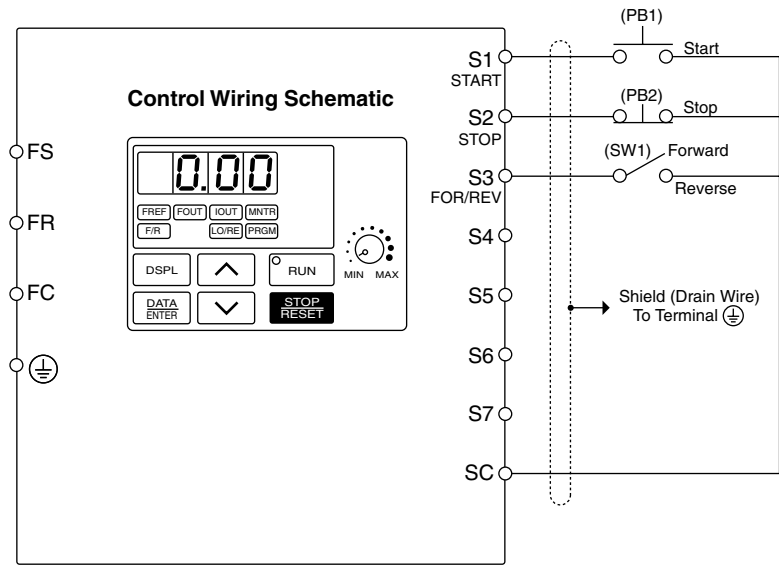

This configuration is best when a person rather than an external controller (PLC, relay, etc.) controls the drive.

OPERATION:

- The frequency reference comes from the digital operator pot.
- Close pushbutton (PB1) momentarily while pushbutton (PB2) is closed, and the drive will run at the frequency setting in U1-01. Pushbutton (PB1) does *NOT* need to be maintained.
- Open pushbutton (PB2) at any time and the drive will stop.
- If switch (SW1) is open, the drive will run in the forward direction. If switch (SW1) is closed, the drive will run in the reverse direction. Switch (SW1) can be operated with the drive running at any speed.
- If the drive is put in the “Local” mode using the LO/RE quick start LED, the drive will behave the same as illustrated in Example 1.

Table 4: Programming Required For Remote 3-wire Sequence & Local Reference

Parameter	Display	Description
n001	11	The drive will perform a 3-wire reset. CAUTION Setting this value will reset all parameters to their original factory settings (all previous adjustments will be lost). <i>When the drive completes the reset, this parameter returns to a value of 1.</i>
n001	4	After doing the reset above, the password parameter returned to a 1. Change it to a 4 to get access to all parameters in the drive.
n004	0	This parameter sets the reference (motor speed) to come from the digital operator potentiometer (local).
n036	Set Motor FLA	Enter the motor’s full load amps (as shown on the motor nameplate).

Example 4: Remote Sequence (2-Wire) & Remote Reference (4 – 20 mA)

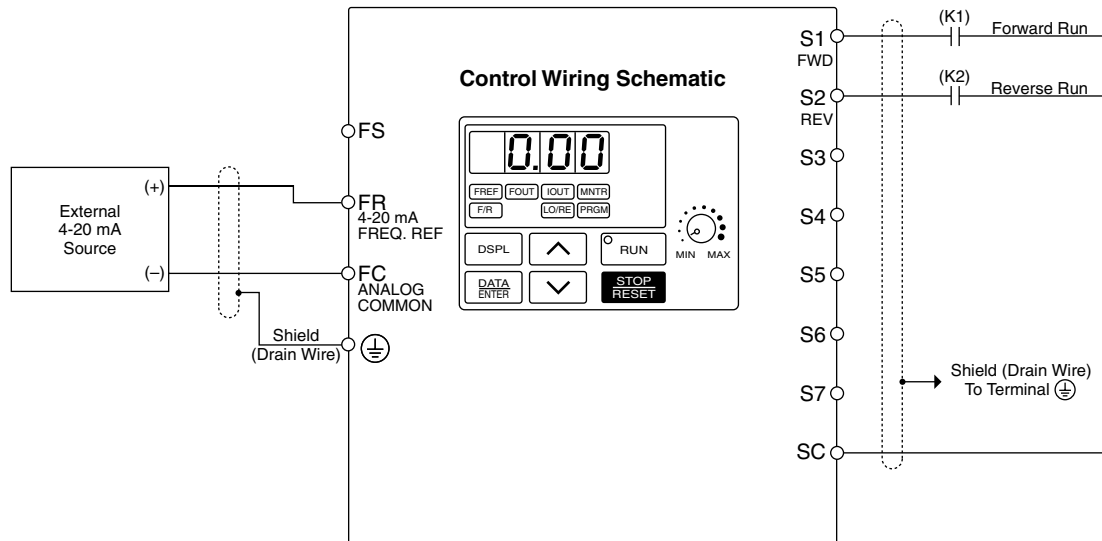

This configuration is used when the start & stop signals and the frequency reference come from a remote source, such as a PLC. It can also be used with a maintained switch when it is desirable to have the drive restart on restoration of power. It should not be used where safety of attending personnel might be threatened by a restart.

OPERATION:

- Close (K1) to Run Forward.
- Close (K2) to Run Reverse.
- If both (K1) & (K2) are closed, the drive stops and displays the error message: “EF.”
- Frequency reference is proportional to the signal level at Terminal FI. 4mA = 0 Hz, 12mA = 30 Hz, & 20mA = 60 Hz.
- If the drive is put in the “Local” mode using the LO/RE quick start LED, the drive will behave the same as illustrated in Example 1.

Table 5: Programming Required For Remote 2-wire Sequence & Remote (4-20 mA) Reference

Parameter	Display	Description
n001	10	The drive will perform a 2-wire reset. CAUTION Setting this value will reset all parameters to their original factory settings (all previous adjustments will be lost). <i>When the drive completes the reset, this parameter returns to a value of 1.</i>
n001	4	After doing the reset above, the password parameter returned to a 1. Change it to a 4 to get access to all parameters in the drive.
n004	3	This parameter sets terminal FR to be a 4-20mA input. NOTE: Switch SW2 (2) must be closed (“on”). See page 2 for SW2(2) location.
n036	Set Motor FLA	Enter the motor’s full load amps as shown on the motor nameplate.

Example 5: Remote Sequence (3-Wire) & Speed Potentiometer

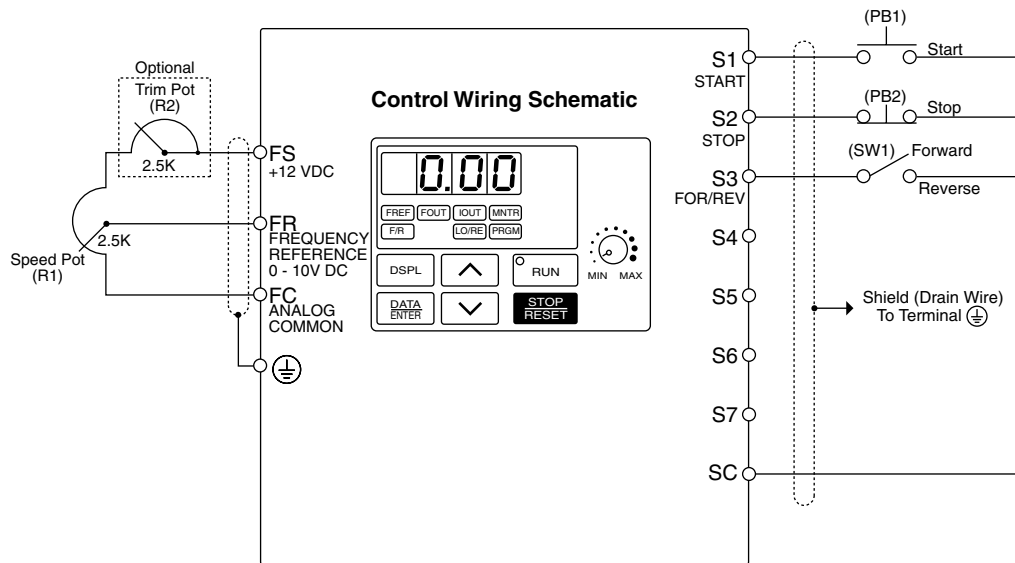

This configuration is best when a person rather than an external controller (PLC, relay, etc.) controls the drive. Both potentiometers ((R1) & (R2)) should have a resistance value between 2000Ω and 3000Ω and be rated for at least 1 Watt. The trim pot is optional, but without it the manual speed pot will output 10V (60 Hz) at just three-quarters of its rotation.

OPERATION:

- Close pushbutton (PB1) momentarily while pushbutton (PB2) is closed and the drive will start. Pushbutton (PB1) does *NOT* need to be maintained.
- Open pushbutton (PB2) at any time and the drive will stop.
- If switch (SW1) is open the drive will run in the forward direction. If switch (SW1) is closed, the drive will run in the reverse direction. Switch (SW1) can be operated with the drive running at any speed.
- Frequency reference is proportional to the signal level at Terminal FV.
0V = 0 Hz, 5V = 30 Hz, & 10V = 60 Hz.
- If the drive is put in the “Local” mode using the LO/RE quick start LED, the drive will behave the same as illustrated in Example 1.

Table 6: Programming Required For Remote 3-wire Sequence & Speed Pot Reference

Parameter	Display	Description
n001	11	The drive will perform a 3-wire reset. CAUTION Setting this value will reset all parameters to their original factory settings (all previous adjustments will be lost). <i>When the drive completes the reset, this parameter returns to a value of 1.</i>
n001	4	After doing the reset above, the password parameter returned to a 1. Change it to a 4 to get access to all parameters in the drive.
n036	Set Motor FLA	Enter the motor’s full load amps as shown on the motor nameplate.

After the programming is complete, the trim pot needs to be calibrated. Press **DSPL** until the FREF quick start LED is illuminated. Turn the Speed Pot (R1) all the way up. Adjust the trim pot (R2) so that the “Frequency Reference” display is just flickering between 59.99 Hz and 60.00 Hz. This completes the trim pot calibration.

Example 6: Remote Sequence (2-Wire) & Remote Reference (0 – 10 VDC) and three digital preset speeds

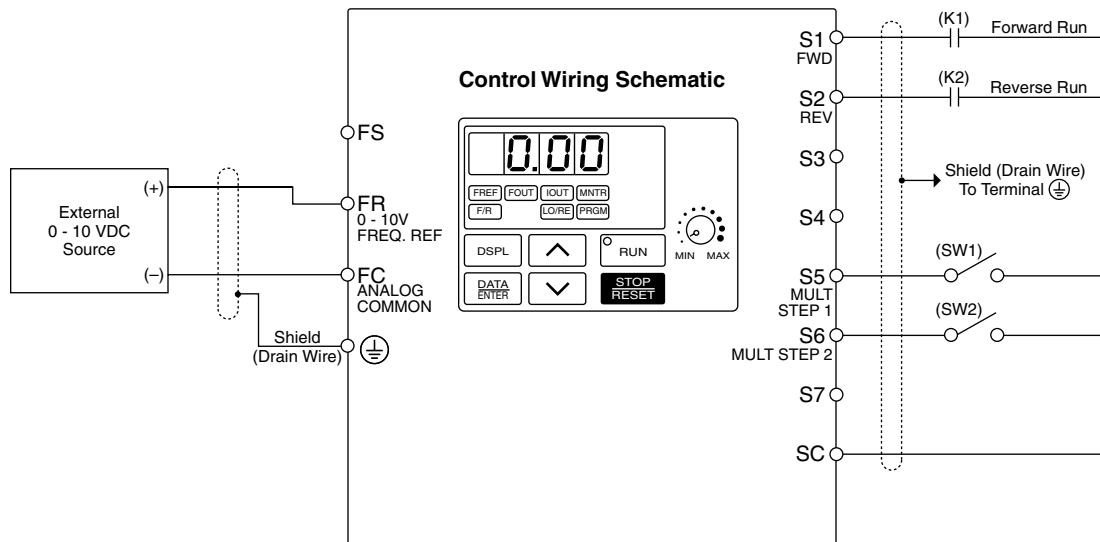

OPERATION:

- Close (K1) to Run Forward.
- Close (K2) to Run Reverse.
- If both (K1) & (K2) are closed, the drive stops and displays the error message: “EF”
- Frequency reference is determined by the status of the switches (SW1) and (SW2).
- If the drive is put in the “Local” mode using the LO/RE quick start LED, the drive will behave the same as illustrated in Example 1.

(SW1) Status	(SW2) Status	Reference Source
Open	Open	Analog value on terminal FR
Closed	Open	Digital value stored in parameter n025
Open	Closed	Digital value stored in parameter n026
Closed	Closed	Digital value stored in parameter n027

Table 7: Programming Required For Remote 2-wire Sequence & Multiple References

Parameter	Display	Description
n001	10	The drive will perform a 2-wire reset. ⚠ CAUTION Setting this value will reset all parameters to their original factory settings (all previous adjustments will be lost). <i>When the drive completes the reset, this parameter returns to a value of 1.</i>
n001	4	After doing the reset above, the password parameter returned to a 1. Change it to a 4 to get access to all parameters in the drive.
n025	User Set	Sets the frequency reference when switch (SW1) is closed and switch (SW2) is open.
n026	User Set	Sets the frequency reference when switch (SW1) is open and switch (SW2) is closed.
n027	User Set	Sets the frequency reference when switches (SW1) and (SW2) are closed.
n036	Set Motor FLA	Enter the motor's full load amps as shown on motor nameplate.

Definitions

Sequence – refers to how the drive is started, stopped, and told which direction to run. When the sequence comes from the digital operator (local), the drive is started and stopped using the “RUN” and “STOP” keys on the digital operator, and direction is given via the “FWD/REV” key. Sequence can also come from the drive’s control terminals (remote) using either two-wire or three-wire control. **The sequence inputs to the drive do NOT require any outside voltages to activate them.** Instead, contact closures (either from switches, relay contacts or open collector circuits) activate the sequence inputs. Other sequence sources are available; consult Paragraph 5.13, Local/Remote Reference and Sequence Selection for details.

Two-wire sequence – utilizes a “maintained” switch or relay contact. It is used on applications where it is desirable to have the drive restart on restoration of power. It should not be used where safety of attending personnel might be threatened by a restart. This method is generally restricted to unattended fans & pumps, or where another controller is entrusted with the decision to restart. Direction is controlled by maintaining either a forward run or a reverse run command.

Three-wire sequence – utilizes “momentary” buttons or switches. This control scheme emulates the traditional 3-wire motor starter control. A momentary closure of a normally open run switch latches the drive in the RUN mode (STOP switch must be closed or the drive will not accept the momentary RUN command). A momentary opening of the normally closed STOP switch unlatches RUN mode bringing the drive to a stop. The three-wire sequence is used where it would be dangerous for the drive to restart after a power outage. This method requires an intentional restart, as the RUN command is unlatched immediately on loss of power. Direction is determined by another maintained contact closure (closed = reverse).

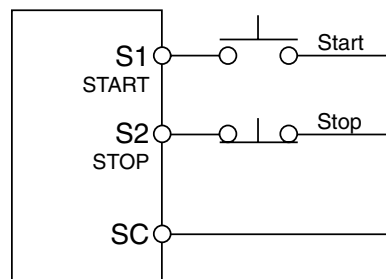

3-Wire Sequence

Reference – The frequency reference tells the drive how fast to run the motor. There are several source options for the frequency reference. First, the frequency reference can come from the digital operator (local). Simply put, the motor speed can be entered into the keypad. Second, the frequency reference can come from an analog signal (remote), such as 0 to 10 Volts DC. When 0 Volts is applied to the drive, the drive will run at zero speed. When 10V is applied to the drive, it will run at full speed. Apply anything in between and the drive will run at that corresponding frequency (2.5VDC = 25% speed = 15 Hz). Other reference sources are available; consult Paragraph 5.11, Frequency Reference Selection for details.

Local Control – when the sequence and/or reference comes from the digital operator.

Remote Control – when the sequence and/or reference comes from the control terminals.

Current Ratings & Horsepower Range

Rated Input Voltage	Current Rating [A]	Nominal Horsepower	Model Number	
			CIMR-V7* <input type="checkbox"/>	MV <input type="checkbox"/>
230V	0.8	1/8	20P1	A001
	1.6	1/4	20P2	A002
	3.0	1/2	20P4	A003
	5.0	3/4 & 1	20P7	A005
	8.0	2	21P5	A008
	11.0	3	22P2	A011
	17.5	5	23P7	A017
	25.0	7.5	25P5	A025
	33.0	10	27P5	A033
460V	1.2	1/2	40P2	B001
	1.8	3/4	40P4	B002
	3.4	1 & 2	40P7	B003
	4.8	3	41P5	B005
	5.5	3	42P2	-
	8.6	5	43P7	B009
	14.8	7.5 & 10	45P5	B015
	18.8	10	47P5	-
	21.0 ⁽¹⁾	15 ⁽¹⁾	47P5 ⁽¹⁾	-

⁽¹⁾ 47P5 drive, with a current rating of 21.0 A and nominal horsepower of 15, is only available as a V74X drive.

WARNING

Do not touch circuit components until main input power has been turned OFF. Status indicator LEDs and Digital Operator display will be extinguished when the DC bus voltage is below 50 VDC. Wait 5 additional minutes.

Do not connect or disconnect wires and connectors while the main input power is turned on.

CAUTION

The Drive leaves the factory with parameters initialized for 2-Wire control (when using external Run/Stop signals). Before using the initialization function of constant n001, know your control wiring configuration:

- 10 = Factory 2-Wire Control Initialization (Maintained RUN Contact)**
- 11 = Factory 3-Wire Control Initialization (Momentary START/STOP Contact)**

Entering either Initialization code resets all parameters to factory settings, and automatically returns parameter n001 setting to “ 1 ”. If the Drive is connected for 3-Wire control and this parameter is set to “ 10 ” (2-Wire Control Initialization), the motor may run in reverse direction WITHOUT A RUN COMMAND APPLIED. Equipment damage or personal injury may result.

Section 1. RECEIVING AND INSTALLATION

1.1 GENERAL

This document pertains to the V7 ac drive. This manual reflects the Software Version 0028 for models CIMR-V7□□□0P1 through V7□□□4P0 and Software Version 0106 for models CIMR-V7□□□5P5 and V7□□□7P5. This document is equally applicable to drives identified as GPD315, GPD315/V7, GPD315/V74X, and V74X. Additionally, in this document, the word “drive”, “ac drive”, and “inverter” may be used interchangeably. The V7 (NEMA type1) and V74X (NEMA type 4X/12), hereafter referred to as the "Drive," are general purpose sine-coded pulse width modulated AC motor drives which generate an adjustable voltage/frequency three phase output for complete speed control of most conventional squirrel cage induction motors. Automatic stall prevention and voltage boost prevent nuisance tripping during load or line side transient conditions. The Drive will not induce any voltage line notching distortion back to the utility line, and it maintains a displacement power factor of not less than 0.98 throughout its speed range.

When properly installed, operated and maintained, the Drive will provide a lifetime of service. It is mandatory that the person who operates, inspects, or maintains this equipment thoroughly read and understand this manual before proceeding.

Information in this manual covers both the NEMA type 1 and NEMA type 4X/12 configuration of the Drive. It also contains basic information for the operator control station. For detailed operation of other units in the drive system, refer to their respective manuals.

1.2 RECEIVING

The Drive is thoroughly tested at the factory. After unpacking, verify the part numbers on the nameplate with the purchase order (invoice). Any damages or shortages evident when the equipment is received must be reported immediately to the commercial carrier who transported the equipment. Assistance, if required, is available from your sales representative.

CAUTION

Do not install a drive that is damaged or missing parts.

If the drive will be stored after receiving, keep it in its original packaging and store according to storage temperature specifications in Appendix 2.

1.3 PHYSICAL INSTALLATION

Location of the Drive is important to achieve proper performance and normal operating life. The unit should be installed in an area where it will be protected from:

- Extreme cold and heat. Use only within the ambient temperature range (for open chassis type): 14 to 122°F (-10 to +50°C)
- Rain, moisture
- Oil sprays, splashes
- Salt spray
- Direct sunlight. (Avoid using outdoors)
- Corrosive gases (e.g. sulfurized gas) or liquids
- Dust or metallic particles in the air
- Physical shock, vibration
- Magnetic noise (Example: welding machines, power devices, etc.)
- High humidity
- Radioactive substances
- Combustibles: thinner, solvents, etc.

When preparing to mount the Drive, lift it by its base, **never** by the front cover. For effective cooling, as well as proper maintenance, the Drive must be installed on a flat, non-flammable vertical surface (wall or panel) using four mounting screws. There **MUST** be a **MINIMUM** 3.9 in. clearance above and below the Drive to allow air flow over the heat sink fins. A minimum 1.2 in. clearance is required on each side of the Drive.

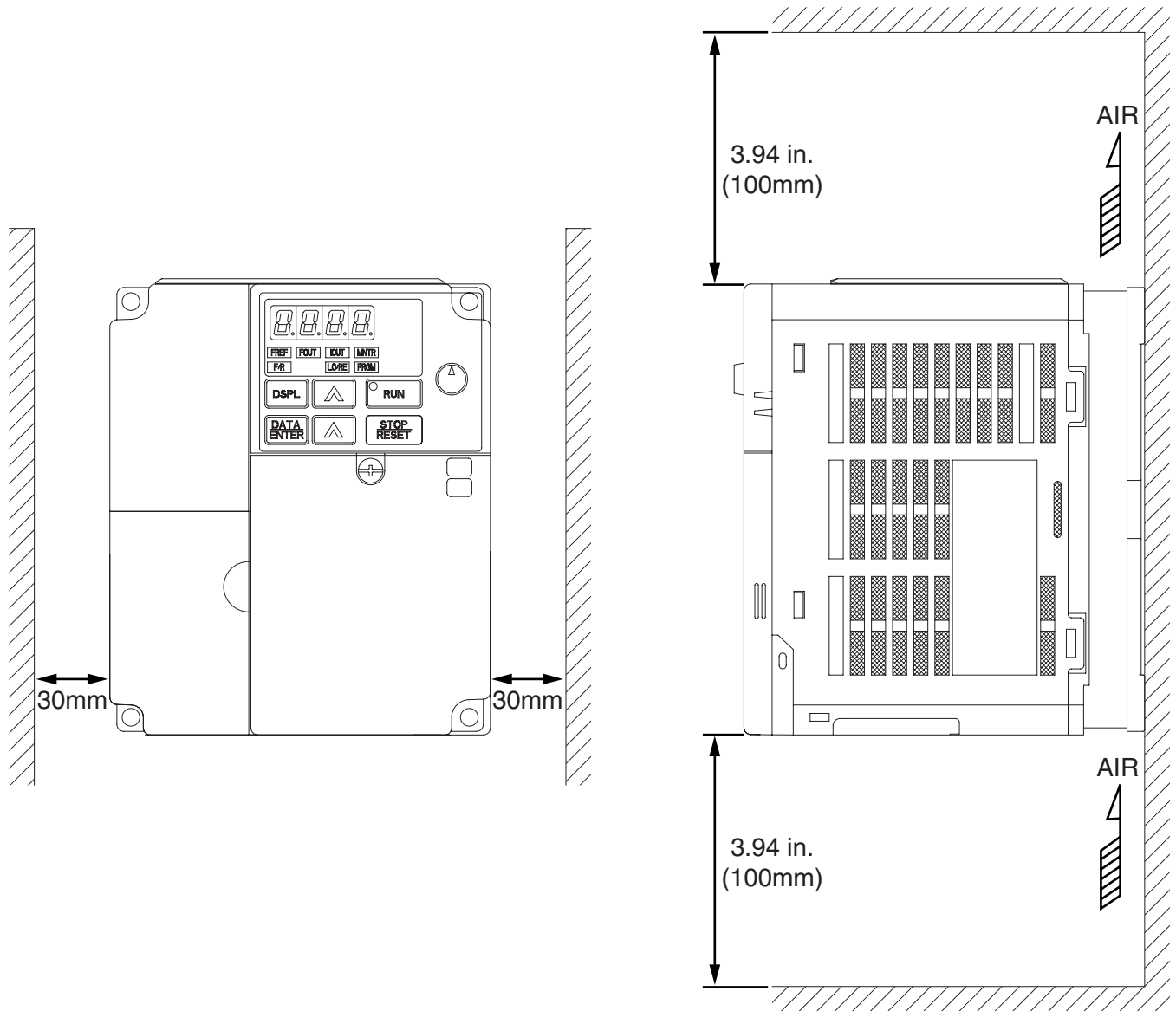

1. To use 5.5/5.7 kw (7.5/10 Hp) Drives as open chassis, remove both top and bottom covers.
2. The clearances required at top/bottom and both sides are common in open chassis type (IP00) and enclosed wall-mounted type (IP20).
3. For the external dimensions and mounting dimensions, refer to the "DIMENSIONS" section of Appendix 5.
4. Allowable intake air temperature to the Drive:

Open chassis type:	-10°C to +50°C
Enclosed wall-mounted type:	-10°C to +40°C
5. Allow sufficient space for the sections at the upper and lower parts marked with * in order to permit the flow of intake/exhaust air to/from the Drive.

1.3 PHYSICAL INSTALLATION

Continued

For details on removing the front panels and accessing the terminals, see Appendix 8.

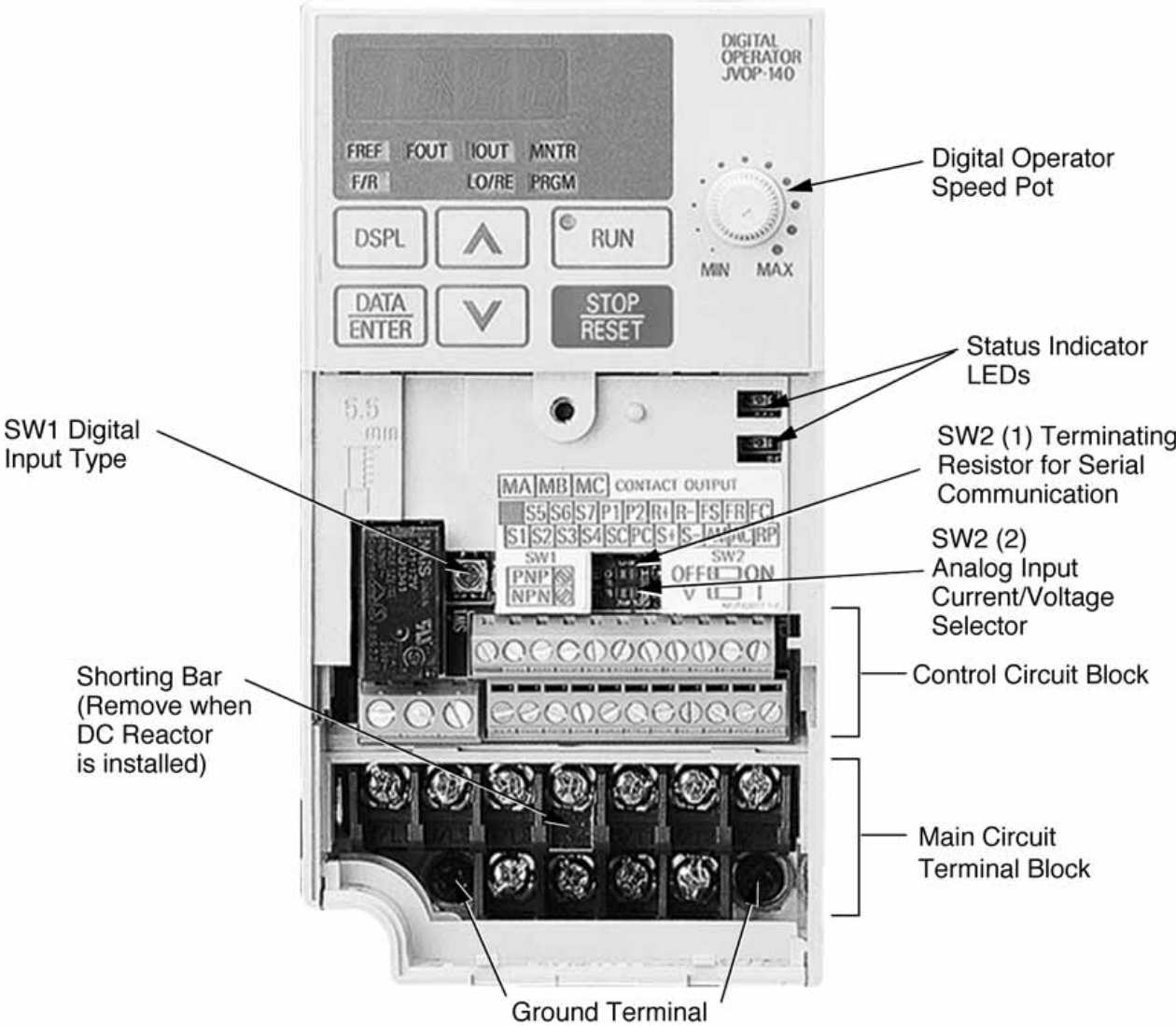

Figure 1-1a. Component Identification

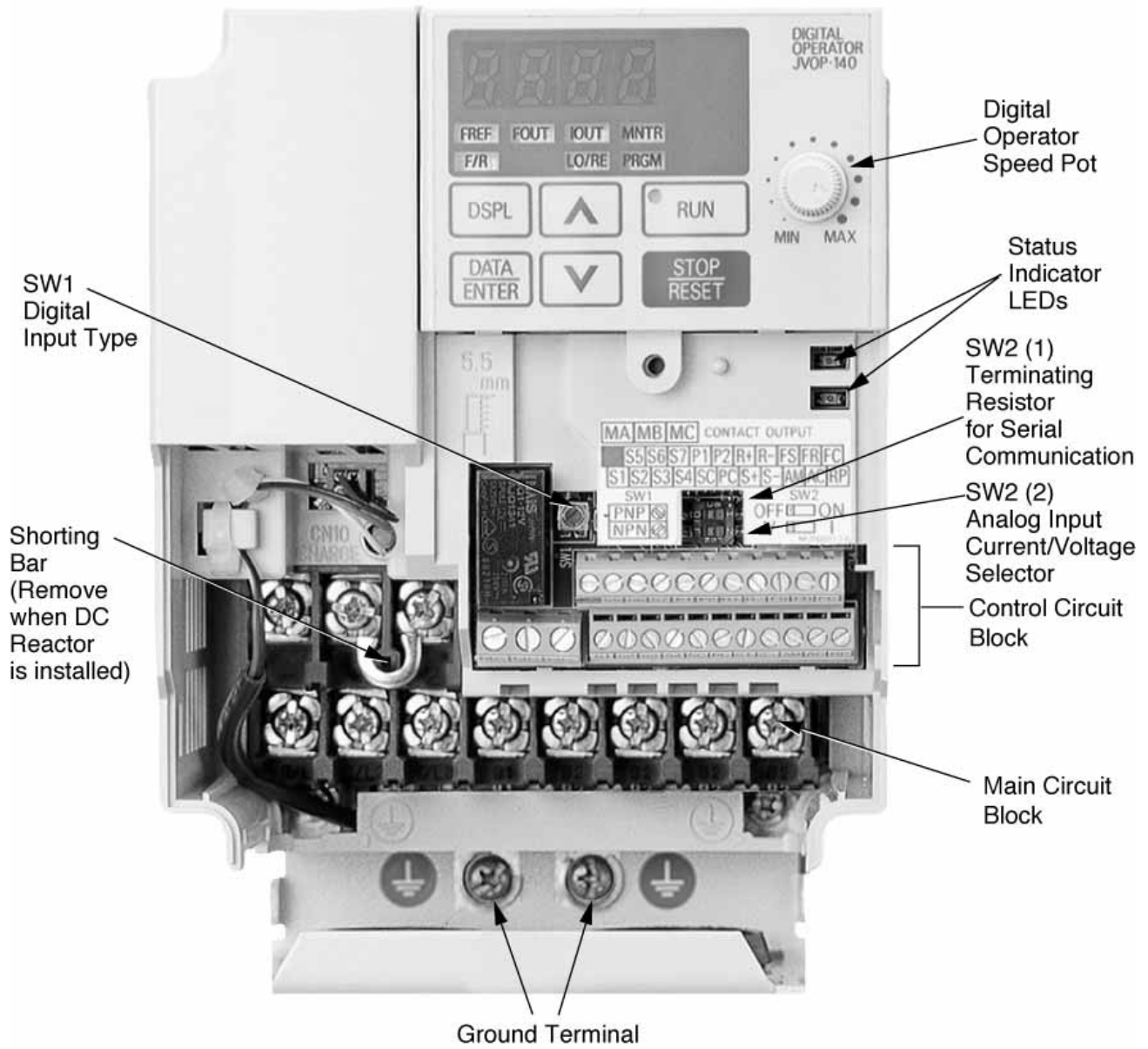
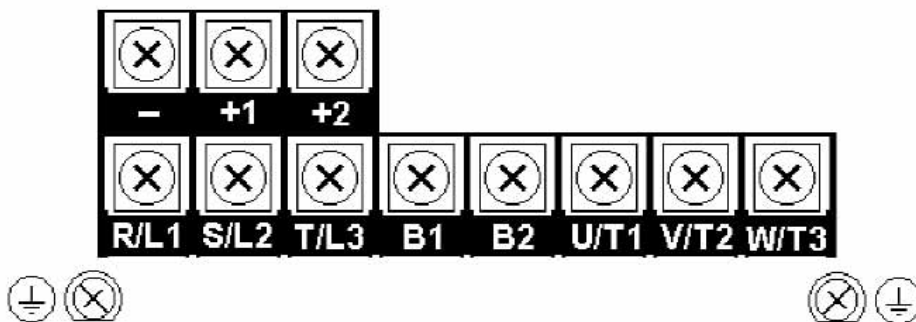

Figure 1-1b. Component Identification

Model	CIMR-V7* <input type="checkbox"/>	20P1	20P2	20P4	20P7
	MV <input type="checkbox"/>	A001	A002	A003	A005



Model	CIMR-V7* <input type="checkbox"/>	21P5	22P2	40P2	40P4	40P7	41P5	42P2
	MV <input type="checkbox"/>	A008	A011	B001	B002	B003	B005	—



Model	CIMR-V7* <input type="checkbox"/>	23P7	43P7
	MV <input type="checkbox"/>	A017	B009

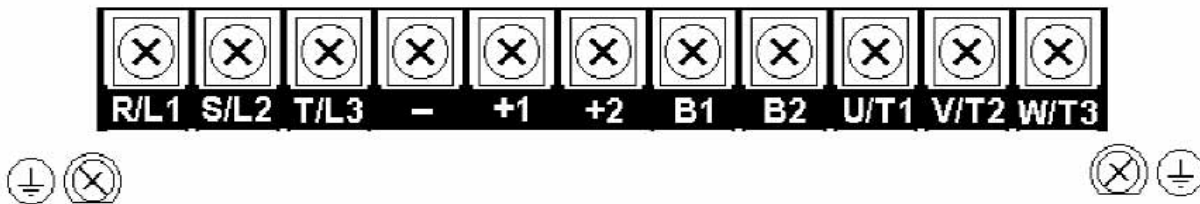

Model	CIMR-V7* <input type="checkbox"/>	25P5	27P5	45P5	47P5
	MV <input type="checkbox"/>	A025	A033	B015	B018

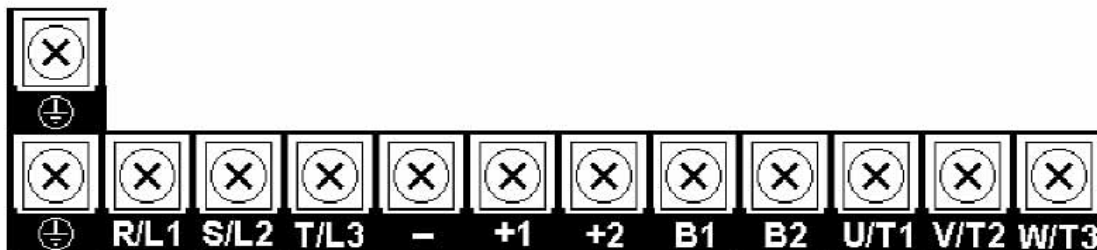

Figure 1-1c. Main Circuit Terminals

1.4 ELECTRICAL INSTALLATION

The Drive leaves the factory with all parameters set for 2-Wire external reference control. Figure 1-5 must be used for all external connections.

To use the Drive in a 3-Wire application, drive parameters **n001**, **n003**, and **n004** must be reprogrammed, using the Digital Operator. Figure 1-6 must then be used for all external connections.

IMPORTANT

When a cable gland is used for water and dust tight type (NEMA type 4X/12) models, observe the following:

- Use multi-core cable for cable gland. (If more than one cable is inserted into one cable gland, a gap is created and may cause leakage.)
- Seal the cable gland with a gasket without fail. (A gasket is attached to the recommended cable gland.)

Cable Gland Mounting Hole

Model CIMR-V7* <input type="checkbox"/>	MV <input type="checkbox"/>	Dimensions in inches (mm)
		Qty-Dia
20P1 20P2 20P4 20P7	A001 A002 A003 A005	3-0.89 DIA (3-Ø 22.6)
21P5 22P2 23P7	A008 A011 A017	3-1.06 DIA (3-Ø 26.8)
25P5 27P5	A025 A033	3-1.38 DIA (3-Ø 35)
40P2 40P4 40P7	B001 B002 B003	3-0.89 DIA (3-Ø 22.6)
41P5 42P2 43P7	B005 - B009	3-1.06 DIA (3-Ø 26.8)
45P5 47P5	B015 -	3-1.38 DIA (3-Ø 35)

A. Main Circuit Input /Output Wiring

Complete wire interconnections according to Table 1-2, Figure 1-5 thru Figure 1-7. Be sure to observe the following:

- Use 600V vinyl-sheathed wire or equivalent. Wire size and type should be determined by local electrical codes.
- Avoid routing power wiring near equipment sensitive to electrical noise.
- Avoid running input and output wiring in the same conduit.
- NEVER connect AC main power to output terminals T1(U), T2(V), and T3(W).
- NEVER allow wire leads to contact metal surfaces. Short-circuit may result.
- NEVER connect power factor correction capacitors to the drive output. Consult Yaskawa when connecting noise filters to the drive output.
- WIRE SIZING MUST BE SUITABLE FOR CLASS I CIRCUITS.
- When connecting motor to drive's output terminals, include a separate ground wire. Attach ground wire solidly to motor frame and to drive's ground terminal \oplus .
- When using armored or shielded cable for connection between drive and motor, solidly connect armor or shield to motor frame, and to drive's ground terminal \oplus .
- Motor lead length should NOT EXCEED 164 feet (50 meters), and motor wiring should be run in a separate conduit from the power wiring. If lead length must exceed this distance, reduce carrier frequency (see paragraph 5.8) and consult factory for proper installation procedures.
- Use UL listed closed loop connectors or CSA certified ring connectors sized for the selected wire gauge. Install connectors using the correct crimp tool recommended by the connector manufacturer.

Table 1-1. Wire and Terminal Screw Sizes

230V 3-phase Input

Model		Terminal Symbol	Screw	Tightening Torque lb • in (N • m)	Wire				Type
CIMR-V7* <input type="checkbox"/>	MV <input type="checkbox"/>				Applicable size		Recommended size		
					mm ²	AWG	mm ²	AWG	
20P1	A001	R/L1, S/L2, T/L3 B1, B2 U/T1, V/T2, W/T3 -, +1,+2 	M3.5	7.1 to 8.88 (0.8 to 1.0)	0.75 to 2	18 to 14	2	14	600V vinyl-sheathed wire or equivalent
20P2	A002		M3.5	7.1 to 8.88 (0.8 to 1.0)	0.75 to 2	18 to 14	2	14	
20P4	A003		M3.5	7.1 to 8.88 (0.8 to 1.0)	0.75 to 2	18 to 10	2	14	
20P7	A005		M3.5	7.1 to 8.88 (0.8 to 1.0)	0.75 to 2	18 to 14	2	14	
21P5	A008		M4	10.65 to 13.31 (1.2 to 1.5)	2 to 5.5	14 to 10	2	14	
22P2	A011		M4	10.65 to 13.31 (1.2 to 1.5)	2 to 5.5	14 to 10	3.5	12	
23P7	A017		M4	10.65 to 13.31 (1.2 to 1.5)	2 to 5.5	14 to 10	5.5	10	
25P5	A025		M5	22.19 (2.5)	5.5 to 8	10 to 8	8	8	
27P5	A033		M5	22.19 (2.5)	5.5 to 8	10 to 8	8	8	

460V 3-phase Input

Model		Terminal Symbol	Screw	Tightening Torque lb • in (N • m)	Wire				Type
CIMR-V7* <input type="checkbox"/>	MV <input type="checkbox"/>				Applicable size		Recommended size		
					mm ²	AWG	mm ²	AWG	
40P2	B001	R/L1, S/L2, T/L3 B1, B2 U/T1, V/T2, W/T3 -, +1,+2  x 1	M4	10.65 to 13.31 (1.2 to 1.5)	2 to 5.5	14 to 10	2	14	600V vinyl-sheathed wire or equivalent
40P4	B002		M4	10.65 to 13.31 (1.2 to 1.5)	2 to 5.5	14 to 10	2	14	
40P7	B003		M4	10.65 to 13.31 (1.2 to 1.5)	2 to 5.5	14 to 10	2	14	
41P5	B005		M4	10.65 to 13.31 (1.2 to 1.5)	2 to 5.5	14 to 10	2	14	
42P2	-		M4	10.65 to 13.31 (1.2 to 1.5)	2 to 5.5	14 to 10	2	14	
43P7	B009		M4	10.65 to 13.31 (1.2 to 1.5)	2 to 5.5	14 to 10	2 3.5 x 1	14 12 x 1	
45P5	B015		M4	12.43 (1.4)	3.5 to 5.5	12 to 10	5.5	10	
47P5	-		M5	22.19 (2.5)	5.5 to 8	12 to 10	5.5	10	

Note: The wire size is set for copper wires at 160°F (75°C)

Control Circuit

Model	Terminal Symbol	Screw	Tightening Torque lb • in (N • m)	Wire				Type	
				Applicable size		Recommended size			
				mm ²	AWG	mm ²	AWG		
Common to all models	MA, MB, MC	M3	4.44 to 5.33 (0.5 to 0.6)	twisted wire single	0.5 to 1.25 0.5 to 1.25	20 to 16 20 to 16	0.75	18	Shielded wire or equivalent
	S1 to S7, P1, P2, SC, PC, R+, R-, S+, S-, FS, FR, FC, AM, AC, RP	M2	1.94 to 2.21 (0.22 to 0.25)	twisted wire single	0.5 to 0.75 0.5 to 1.25	20 to 18 20 to 16	0.75	18	

Table 1-2. Main Circuit Terminal Functions and Voltages

TERMINAL	FUNCTION	VOLTAGE / SIGNAL LEVEL
L1 (R) L2 (S) L3 (T)	Main circuit input power supply	230V Drive: 200 / 208 / 220 / 230V at 50/60 Hz 460V Drive: 380 / 400 / 440 / 460 / 480V at 50/60 Hz
T1 (U) T2 (V) T3 (W)	Main circuit output	230V Drive: 0 - 200 / 208 / 220 / 230V 460V Drive: 0 - 400 / 440 / 460 / 480V
B1 B2	For connection of braking resistor (option)	
+1 +2	DC Reactor terminals	
-	DC Bus terminals (+1 & -)	
	Ground terminal (100 ohms or less)	-----

B. Control Circuit

All basic control circuit (signal) interconnections are shown in the appropriate diagram:

- Interconnections for external two-wire control in combination with the Digital Operator are shown in Figure 1-5.
- Interconnections for external three-wire control in combination with the Digital Operator are shown in Figure 1-6.

Make wire connections according to Figures 1-5 thru 1-7 and Table 1-3; observe the following:

- Signal Leads: Terminals S1-S7 & SC; RP, FS, FR & FC; R+, R-, S+, S-; & AM & AC.
- Control Leads: Terminals P1, P2 & PC; MA, MB & MC.
- Use twisted shielded or twisted-pair shielded wire (20-16 AWG [0.5 – 1.25mm²]) for control and signal circuit leads. The shield sheath **MUST** be connected at the drive end **ONLY** (terminal \oplus). The other end should be dressed neatly and left unconnected (floating). See Figure 1-2.
- Signal leads and feedback leads (PG) must be separated from control leads main circuit leads, and any other power cables, to prevent erroneous operation caused by electrical noise.
- Lead length should **NOT EXCEED** 164 feet (50 meters). Wire sizes should be determined considering the voltage drop.
- All AC relays, contactors and solenoids should have RC surge suppressors installed across their coils.
- All DC relays, contactors and solenoids should have diodes installed across their coils.

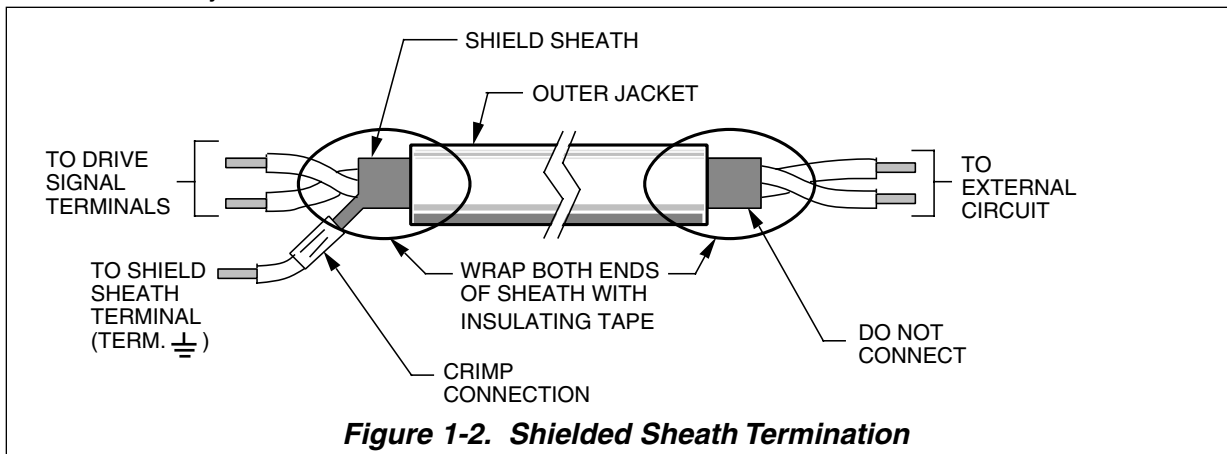

C. Grounding

- The drive must be solidly grounded using the main circuit ground terminal \oplus .
- If Drive is installed in a cabinet with other equipment, ground leads for all equipment should be connected to a common low-impedance ground point within the cabinet.
- The supply neutral should be connected to the ground point within the cabinet.
- Select appropriate ground wire size from Table 1-1.
- Make all ground wires as short as practical.
- **NEVER** ground the drive in common with welding machines, or other high power electrical equipment.
- Where several drives are used, ground each directly to the ground point (see Figure 1-1). **DO NOT FORM A LOOP WITH THE GROUND LEADS.**
- When connecting a motor to the drive's output terminals, include a separate ground wire. Attach ground wire solidly to motor frame and to drive's ground terminal \oplus .
- When using armored or shielded cable for connection between drive and motor, solidly connect armor or shield to motor frame, and to the drive's ground terminal \oplus .

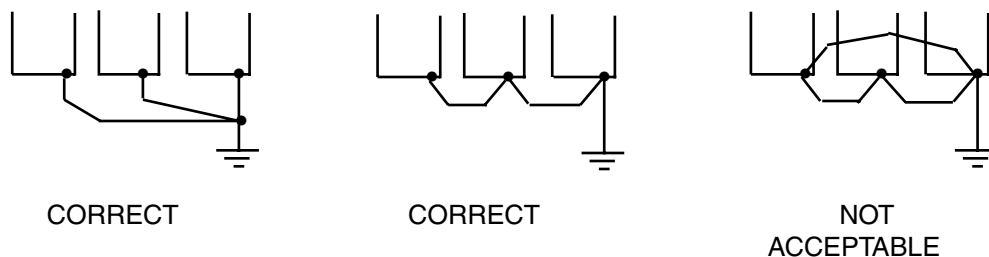

Table 1-3. Terminal Functions and Signals of Control Circuit

DATA	FUNCTION		DESCRIPTION*
S1	Multi-Function-Input 1		Factory setting is " Forward Run/Stop " (1). (Forward run when closed, stop when open)
S2	Multi-Function-Input 2		Factory setting is " Reverse Run/Stop " (1). (Reverse Run when closed, stop when open)
S3	Multi-Function-Input 3		Factory setting is " External Fault (NO contact) input " (1)
S4	Multi-Function-Input 4		Factory setting is " Fault Reset " (1)
S5	Multi-Function-Input 5		Factory setting is " Multi-step Speed Reference 1 " (1)
S6	Multi-Function-Input 6		Factory setting is " Multi-step Speed Reference 2 " (1)
S7	Multi-Function-Input 7		Factory setting is " Jog Reference " (1)
SC	Sequence common for terminals S1-S7.		Common terminal for sequence inputs
FS	Frequency reference power supply		+12 VDC
FR	Frequency reference input		0 to +10V/100% (20K ohms) or 4-20 mA (250 Ω)
RP	Frequency reference –Pulse Train input		30 KHz maximum pulse input
FC	Frequency reference input common		0 V
MA	Multi-function contact output – NO contact	Factory Setting is " Fault "	Contact capacity: 250 Vac at 1A or below 30 Vdc at 1A or below
MB	Multi-function contact output – NC contact		
MC	Multi-function contact output – Common		
AM	Multi-function analog monitor (+)	Factory setting is " Output frequency " 0-10V = 0-100%	Monitor output: 0 to +10V; 2 mA maximum.
AC	Analog monitor common	0 V	
P1	Multi-Function Open Collector Output 1	Factory setting is " Drive Running "	Photocoupler output: 48 VDC; 50 mA or less.
P2	Multi-Function Open Collector Output 2	Factory setting is " Speed Agree "	
PC	Multi-Function Open Collector Output common	0 V	
R+	Receive input (+)	MODBUS communication RS-485 or RS-422.	RS-485/422 MODBUS protocol, 19.2 kps max.
R-	Receive input (-)		
S+	Send output (+)		
S-	Send output (-)		

NOTES:

1. These inputs have factory settings based on 2-wire reset. For 3-wire reset definitions, see Figure 1-6.

D. Auxiliary Input and Output Power Option Devices

A disconnect device (circuit breaker, contactor, disconnect switch, etc.) should NOT be used as a means of starting and stopping the drive or motor.

A disconnect device can be installed for emergency stop purposes, but when that disconnect device is opened, there may be loss of electrical braking.

Figure 1-3 is a factory guideline for proper wiring practices and relative locations within the electrical path from the line to the load. It does not imply what devices are needed for a particular application, nor does it show what devices were shipped with a particular order. Therefore, disregard those items in the diagram which are not being used in your installation. However, it is recommended that an input or DC reactor be used with all Drive ratings when wired to a source of 600 kVA or greater. Mount all optional power devices close to the drive, and keep electrical connections as short as possible.

DO NOT run input and output wiring in the same conduit.

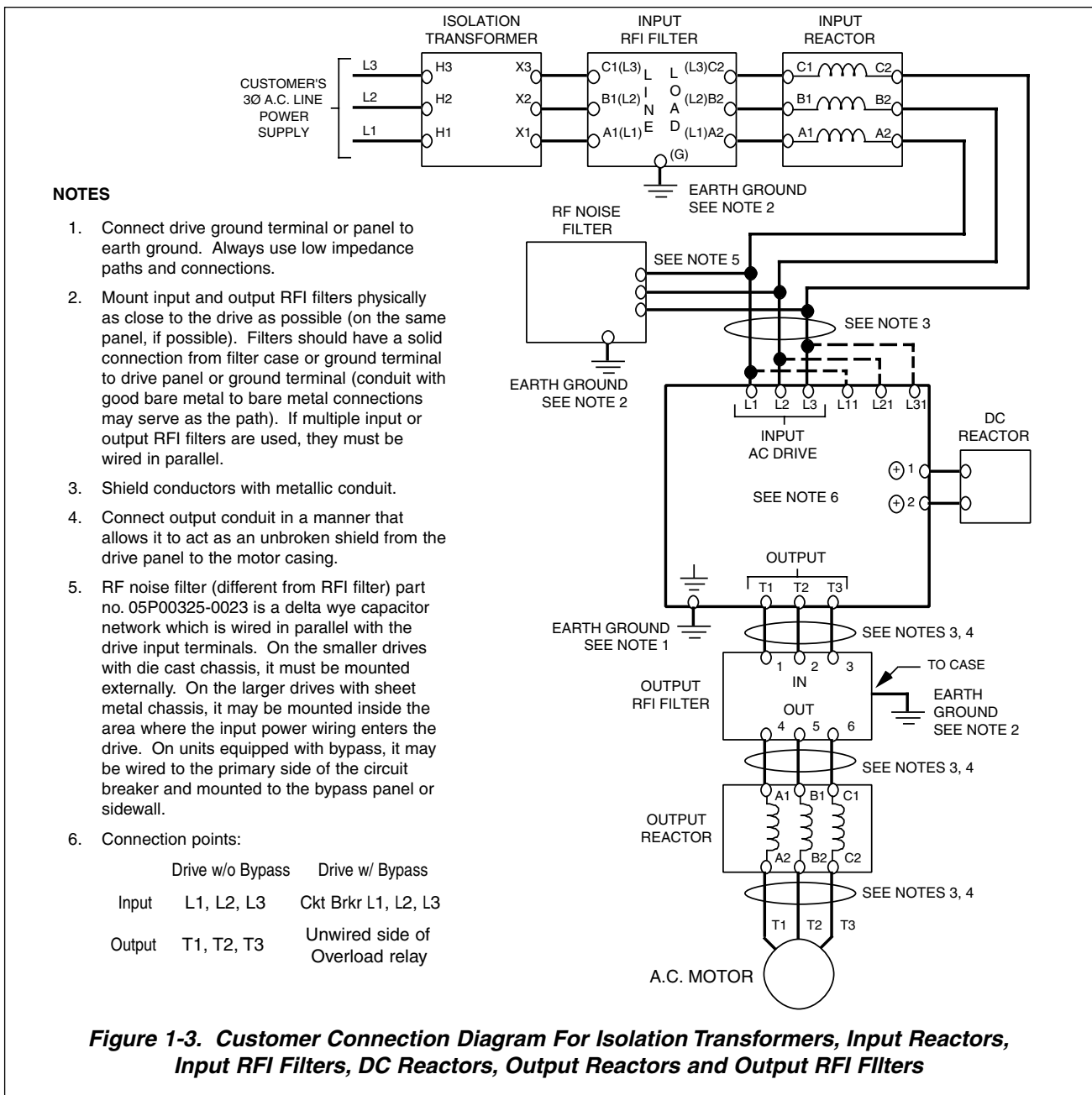

E. Conformance to European EMC Directive

In order to conform to EMC standards, the following methods are required for line filter application, cable shielding and drive installation.

The line filter and Drive must be mounted on the same metal plate. The filter should be mounted as close to the drive as practical. The cable must be kept as short as possible and the metal plate should be securely grounded. The ground of the line filter and the drive must be bonded to the metal plate with as much bare-metal contact as possible.

For main circuit input cables, a screened cable is recommended within the panel and is also suggested for external connections. The screen of the cable should be connected to a solid ground. For the motor cables, a screened cable (max. 20 m) must be used and the screen of the motor cable should be connected to ground at both ends by a short connection, again using as much bare-metal contact as practical.

For a more detailed explanation, refer to the manufacturer document EZZ006543, "Installation Guidelines For EMC Directive using AC Drive Products."

Table 1-4 and Figure 1-4 show the line filter list for EMC standards and the installation/wiring of the Drive and line filter.

Table 1-4. Line Filters for EMC Standards

Model		Line Filter					
CIMR-V7* <input type="checkbox"/>	MV <input type="checkbox"/>	Part Number FIL00 <input type="checkbox"/>	Rated Current (A)	Weight lbs. (kg)	Dimensions in in. (mm) H x W x D ⁽¹⁾	Mounting Dim. in in. (mm) H1 x W1	Screw Size
20P1	A001	1083	10	1.8 (0.8)	7.6 x 3.2 x 2.0 (194 x 82 x 50)	7.1 x 2.4 (181 x 62)	M5
20P2	A002						
20P4	A003						
20P7	A005						
21P5	A008	1084	16	2.2 (1.0)	6.7 x 4.4 x 2.0 (169 x 111 x 50)	6.1 x 3.6 (156 x 91)	M5
22P2	A011	1085	26	2.4 (1.1)	6.9 x 5.7 x 2.0 (174 x 144 x 50)	6.3 x 4.7 (161 x 120)	M5
23P7	A017						
25P5	A025						
27P5	A033	1100	50	5.1 (2.3)	12.0 x 7.2 x 2.2 (304 x 184 x 56)	11.3 x 5.9 (288 x 150)	M6
40P2	B001	1086	5	2.2 (1.0)	6.7 x 4.4 x 1.8 (169 x 111 x 45)	6.1 x 3.6 (156 x 91)	M5
40P4	B002						
40P7	B003						
41P5	B005	1087	10	2.2 (1.0)	6.7 x 4.4 x 1.8 (169 x 111 x 45)	6.1 x 3.6 (156 x 91)	M5
42P2	—						
43P7	B009	1088	15	2.4 (1.1)	6.9 x 5.7 x 2.0 (174 x 144 x 50)	6.3 x 4.7 (161 x 120)	M5
45P5	B015	1101	30	5.1 (2.3)	12.0 x 7.2 x 2.2 (304 x 184 x 56)	11.3 x 5.9 (288 x 150)	M6
47P5	—						

⁽¹⁾ D is the distance the filter will extend outward from the surface of the metal plate.

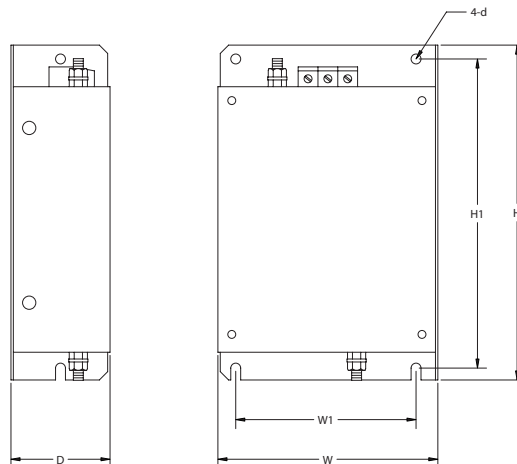

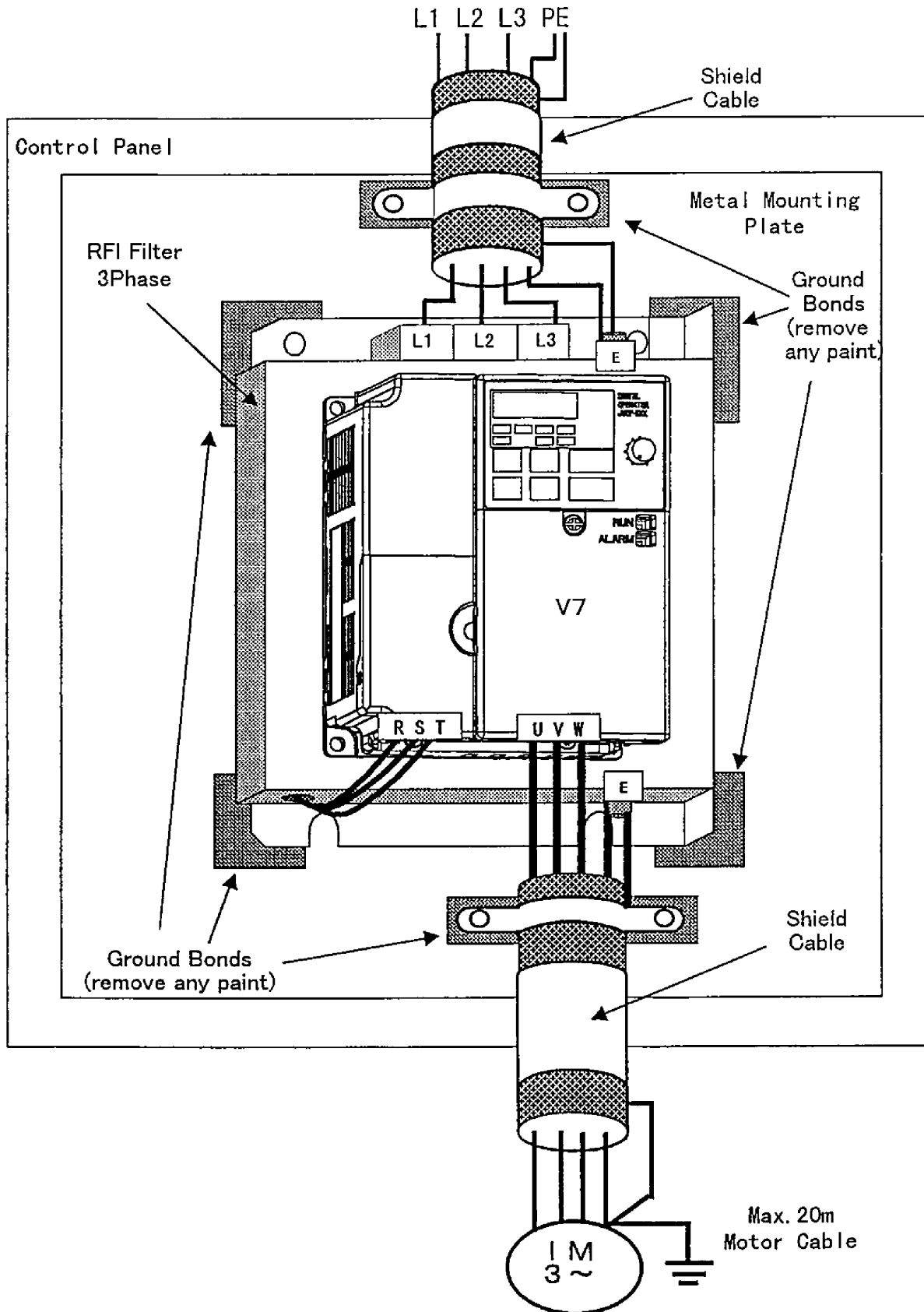



Figure 1-4. Installation of Line Filter and V7 Drive

F. Interconnection - 2 Wire

NOTES FOR FIGURE 1-5

- * – Indicates components not supplied.
 - ⊙ – Main circuit terminal.
 - – Indicates control circuit terminal.
 - () – Indicates alternate terminal marking, i.e., (R) and L1.
 - ▲ – Function labels shown for these terminals are determined by factory settings of **n050** through **n056** (see paragraph 5.18).
 - – Function labels shown for these terminals are determined by factory settings of **n057** through **n059** (see paragraph 5.19).
 - ◆ – Function label shown for this terminal is determined by factory setting of **n004** (see paragraph 5.11A).
 - – Function labels shown for these terminals are determined by factory setting of **n066** (see paragraph 5.17).
1. Insulated twisted shielded wire is required.
 - 2-conductor #18 GA. (Belden #8760 or equivalent).
 - 3-conductor #18 GA. (Belden #8770 or equivalent).
 Connect shield ONLY AT the Drive END (ground terminal ). Stub and isolate other end.
 2. +12V voltage output current capacity of control terminal FS is 20mA max.
 3. The Drive's Electronic Thermal Overload function (**n036**, **n037**) meets standards set by UL and CUL for motor thermal overload protection. If local code requires a separate mechanical overload protection, an overload relay should be installed, interlocked with the Drive as shown. It should be the manual reset type to prevent automatic restart following a motor fault and subsequent contact reclosure after cool down.
 4. Customer to connect terminal  to earth ground.
 5. If the Digital Operator is used, remote operators, which duplicate functions of its command keys may not be required. See Figure 4-1.
 6. For installation of Braking Resistor or Braking Resistor unit, refer to Appendix 6, "Dynamic Braking Option."
 7. An optional DC reactor may be added for harmonic attenuation, if needed. See separate instruction sheet for wiring.
 8. If application does not allow reverse operation, parameter **n006**, Reverse Run Prohibit Selection, should be set to " 1 " (Reverse Run Disabled), and the Reverse Run/Stop input can be eliminated.

 **WARNING**

9. **Input fuses are required for proper branch circuit short circuit protection for all NEMA Type 4 drives. Failure to use recommended fuses (see appendix 4) may result in damage to the drive and/or personal injury.**

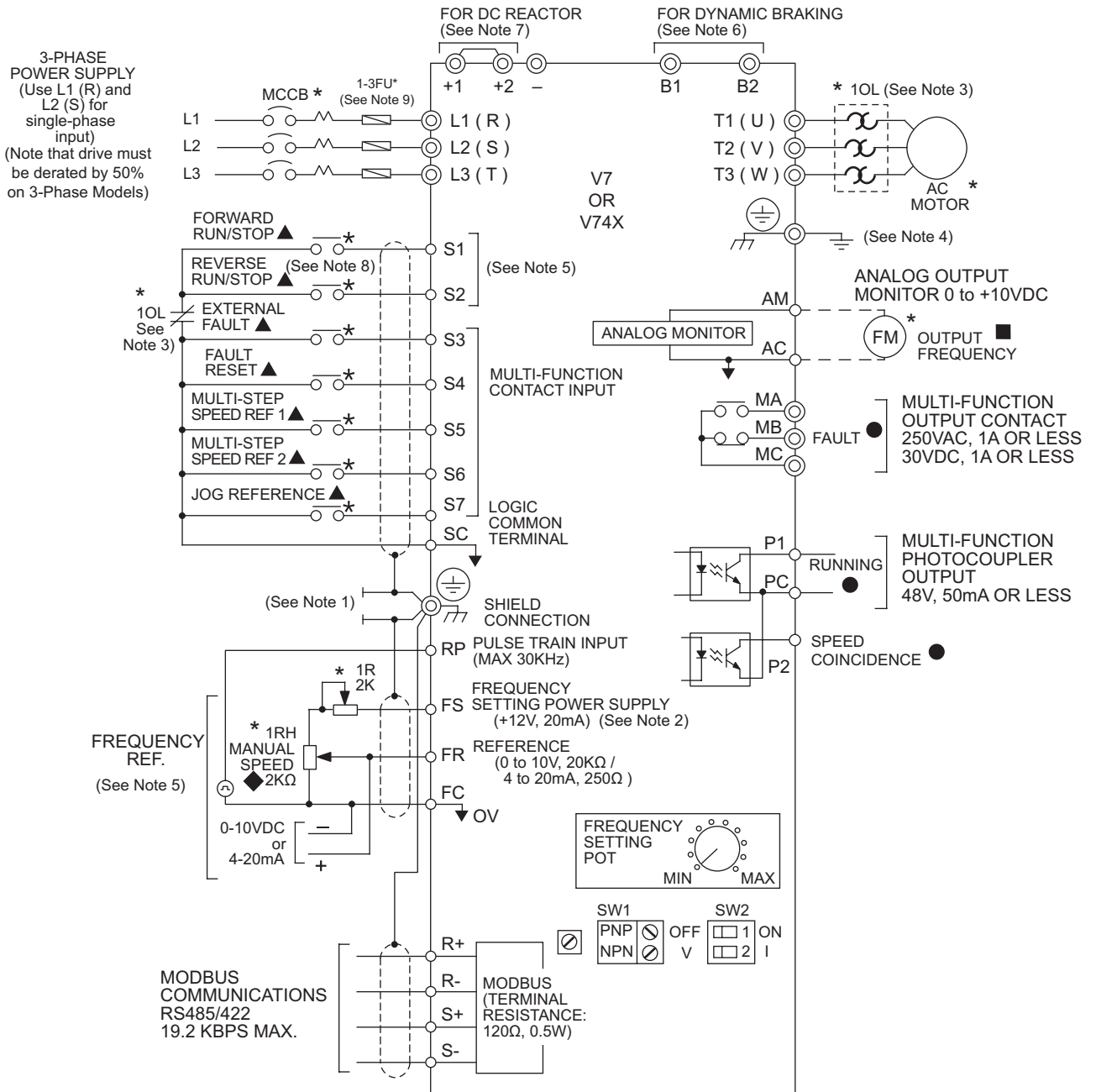

**Figure 1-5. Standard Connections (2-Wire Control)
(Parameter n001 set to "10")**

H. Inspection. After wiring is complete, verify that all wiring is correctly installed, excess screws and wire clippings are removed from inside of unit, screws are securely tightened, and exposed wire does not contact other wiring or terminals.

CAUTION

If a FWD or REV run command is given from the control circuit terminal when the operation method selection function (n003) is set to " 1 " and the "LO/RE" selection is set to "RE", the motor will start automatically as soon as power is applied to the main circuit.

G. Interconnection - 3 Wire

NOTES FOR FIGURE 1-6

- * – Indicates components not supplied.
 - ⊙ – Main circuit terminal.
 - – Indicates control circuit terminal.
 - () – Indicates alternate terminal marking, i.e., (R) and L1.
 - ▲ – Function labels shown for these terminals are determined by factory settings of *n050* through *n056* (see paragraph 5.18).
 - – Function labels shown for these terminals are determined by factory settings of *n057* through *n059* (see paragraph 5.19).
 - ◆ – Function label shown for this terminal is determined by factory setting of *n004* (see paragraph 5.11A).
 - – Function labels shown for these terminals are determined by factory setting of *n066* (see paragraph 5.17).
1. Insulated twisted shielded wire is required.
 - 2-conductor #18 GA. (Belden #8760 or equivalent)
 - 3-conductor #18 GA. (Belden #8770 or equivalent)
 Connect shield only at the Drive end (ground terminal (⊕)). Stub and isolate other end.
 2. +12V voltage output current capacity of control terminal FS is 20mA max.
 3. The Drive's Electronic Thermal Overload function (*n036*, *n037*) meets standards set by UL and CUL for motor thermal overload protection. If local code requires a separate mechanical overload protection, an overload relay should be installed, interlocked with the Drive as shown. It should be the manual reset type to prevent automatic restart following a motor fault and subsequent contact reclosure after cool down.
 4. Customer to connect ground terminal (⊕) to earth ground.
 5. If Digital Operator is used, remote operators which duplicate functions of its command keys (see Figure 4-1) may not be required.
 6. For installation of Braking Resistor or Braking Resistor Unit, refer to Appendix 6, "Dynamic Braking Option".
 7. An optional DC reactor may be added for harmonic attenuation, if needed; see separate instruction sheet for wiring.
 8. If application does not allow reverse operation, parameter *n006*, Reverse Run Prohibit Selection, should be set to " 1 " (Reverse Run Disabled) and Fwd/Rev input can be eliminated.

 **WARNING**

9. **Input fuses are required for proper branch circuit short circuit protection for all NEMA type 4 drives. Failure to use recommended fuses (see appendix 4) may result in damage to the drive and/or personal injury.**

 **CAUTION**

Parameter *n050* must be set to " 0 ", AND parameter *n001* must be set to " 11 ". Resetting drive parameter *n001* to " 10 " may cause the motor to run in reverse direction WITHOUT A RUN COMMAND, and possibly result in equipment damage or personal injury.

1.4 ELECTRICAL INSTALLATION

Continued

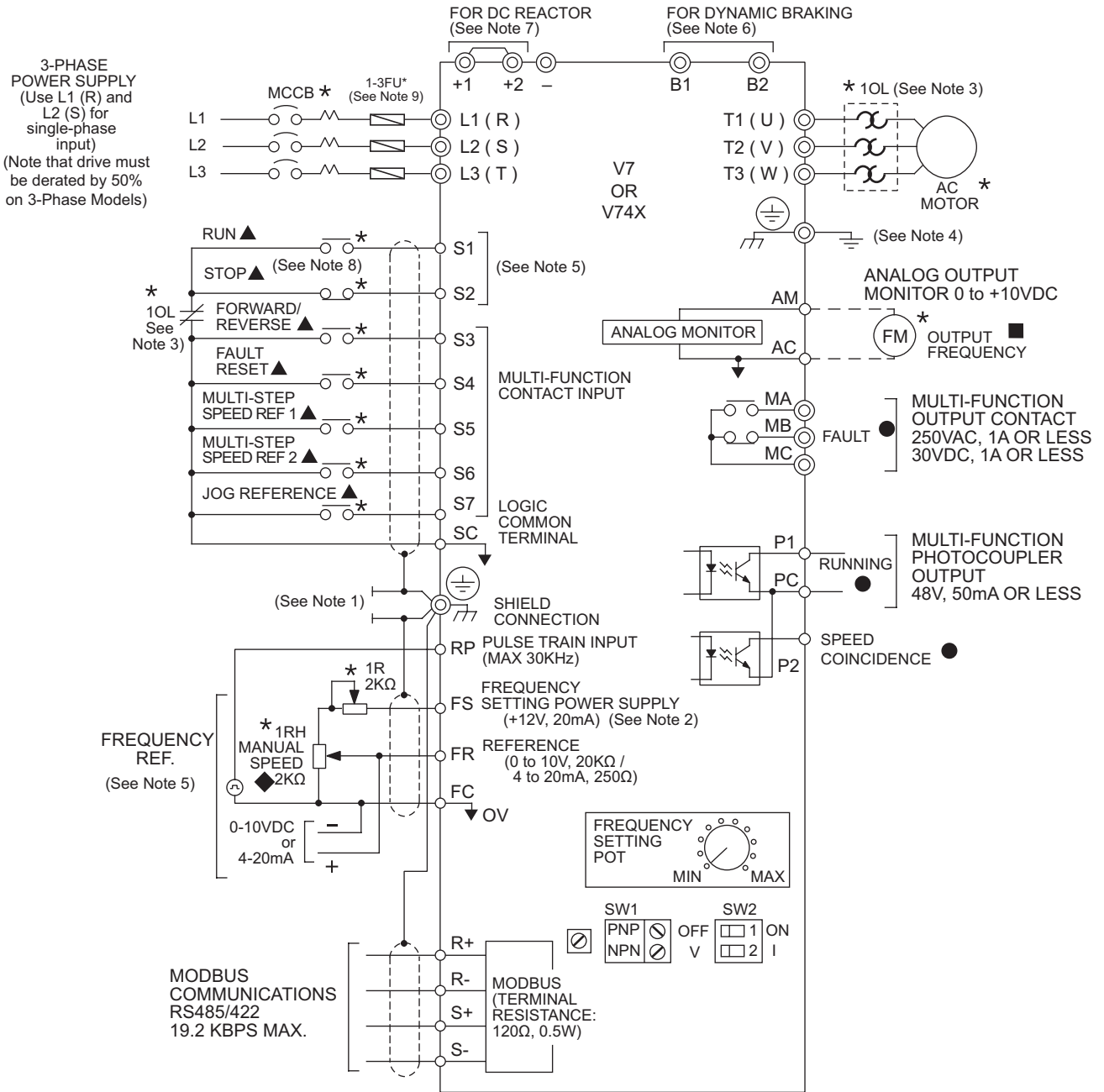

Figure 1-6. Standard Connections (3-Wire Control) (Parameter n001 set to "11")

H. Inspection. After wiring is complete, verify that all wiring is correctly installed, excess screws and wire clippings are removed from inside of unit, screws are securely tightened, and exposed wire does not contact other wiring or terminals.

⚠ CAUTION

If a FWD or REV run command is given from the control circuit terminal when the operation method selection function (n003) is set to " 1 " and the "LO/RE" selection is set to "RE", the motor will start automatically as soon as power is applied to the main circuit.

Section 2. INITIAL START-UP

2.1 PRE-POWER CHECKS

- Verify wires are properly connected and no erroneous grounds exist.
- Remove all debris from the Drive enclosure, such as loose wire clippings, metal shavings, etc.
- Verify all mechanical connections inside the Drive are tight.
- Verify motor is not connected to load.
- Apply input power only after the front cover is in place. DO NOT remove the front cover or Digital Operator while input power is on.
- Determine the proper control method for the application.

Open Loop Vector Control - Use section 2.2 for startup instructions

Parameter **n002 = 1**. Open Loop Vector Control method should be used for most constant torque applications of the Drive. With this control method there is excellent starting torque and excellent speed regulation. The startup procedure for this control method is slightly more complicated.

V/f Control - Use section 2.3 for startup instructions

Parameter **n002 = 0**. V/f control should be used for most variable torque applications. Variable torque applications would include: fan, blower, centrifugal pump, and mixers. Generally variable torque loads do not require high levels of starting torque. V/f control can also be used for some constant torque loads where starting torque and speed regulation are not critical.

2.2 OPEN LOOP VECTOR STARTUP

NOTE: 2-wire or 3-wire sequence selection must be made prior to using this startup procedure or making any other adjustments (parameter n001).

Table 2-1. Open Loop Vector Startup Procedure



















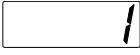

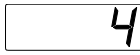







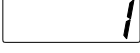







DESCRIPTION	KEY SEQUENCE	DIGITAL OPERATOR DISPLAY
<p>Set the highest parameter access level. This will allow all parameters to be viewed and set.</p>	<p>Press the  key until the  LED is lit on the digital operator.</p> <p>Press .</p> <p>Press  three times.</p> <p>Press .</p>	       
<p>Set drive for Open Loop Vector control. This is accomplished by setting n002 = 1</p>	<p>Press  then .</p> <p>Use the  &  keys to set a "1" in the display.</p> <p>Then press .</p>	     
<p>Set motor rated voltage. (This can be obtained from the nameplate of the motor.)</p>	<p>Press and hold  until n012 is displayed on the digital operator.</p> <p>Then press .</p> <p>Use the  &  keys until the number in the display matches the motor rated voltage.</p> <p>Then press .</p>	       

Table 2-1. Open Loop Vector Startup Procedure - Continued













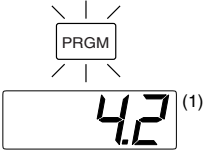
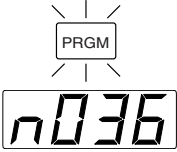

DESCRIPTION	KEY SEQUENCE	DIGITAL OPERATOR DISPLAY
<p>Set motor rated current. (This can be obtained from the nameplate of the motor.)</p>	<p>Press and hold  until n036 is displayed on the digital operator.</p> <p>Then press .</p> <p>Use the  &  keys until the number in the display matches the motor rated current.</p> <p>Then press .</p>	 
<p>Set the motor rated slip. This can be calculated by using the following formula:</p> $\text{Slip} = \frac{(\text{Ns} - \text{Nr}) * \text{P}}{120}$ <p>Where: Ns = Motor synch. speed ⁽²⁾ Nr = Motor rated speed P = Number of motor poles</p> <p>Example: $\text{Slip} = \frac{(1800 - 1725) * 4}{120}$ Slip = 2.5</p>	<p>Press and hold  until n106 is displayed on the digital operator.</p> <p>Then press .</p> <p>Use the  &  keys until the number in the display matches the calculated slip value (see equation at left).</p> <p>Then press .</p>	 
<p>Prepare to test run the drive from the Digital Operator. Motor should be disconnected from the load.</p> <p>This will set the drive into the "Local" mode and bring up the motor current display.</p>	<p>Press and hold  several times until the  LED is lit.</p> <p>Press the  key once.</p> <p>Display the drive's output current by pressing  four times. Turn the Digital Operator Pot all the way to the left (counter-clockwise).</p>	  

Table 2-1. Open Loop Vector Startup Procedure - Continued



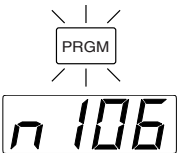



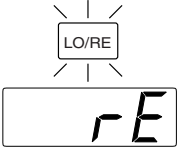
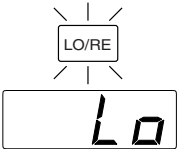
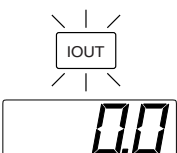



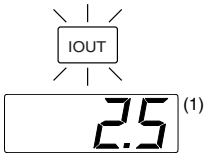

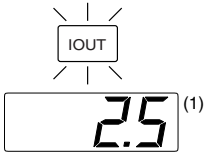
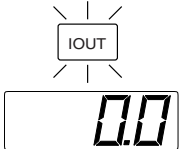
DESCRIPTION	KEY SEQUENCE	DIGITAL OPERATOR DISPLAY
<p>Test run the drive from the Digital Operator.</p>	<p>WARNING: The next key press will cause the motor to turn! Take appropriate safety precautions!</p> <p>Press the  key then slowly turn the Digital Operator Pot to the right about 1/4 of a turn. The display on the drive will show the actual motor amps.</p> <p>Operation checkpoints:</p> <ul style="list-style-type: none"> • Motor rotates smoothly • Motor rotates in correct direction. (If motor does not rotate in the proper direction, stop the motor and remove power from the Drive. Switch motor connections T1 (U) and T2 (V) at the Drive.) • Motor has no abnormal vibration or noise. • Acceleration and deceleration are smooth. • Unit is not overloaded. (Displayed current does not exceed drive rated current). 	
<p>Determine the motor “no load current.”</p>	<p>With the drive still running, turn the Digital Operator Pot all the way to the right (full speed) and record the current on the display.</p> <p>Actual Value: _____</p> <p>Press the  button to stop the drive.</p>	 

Table 2-1. Open Loop Vector Startup Procedure - Continued

DESCRIPTION	KEY SEQUENCE	DIGITAL OPERATOR DISPLAY
<p>Set the motor “no load current” in the drive.</p> <p>Motor no load current is set as a percentage of motor rated current. It is calculated using the formula:</p> $\frac{I_{\text{no load}} * 100}{I_{\text{rated}}} = n110$ <p>Where: $I_{\text{no load}}$ = Motor no load current (measured in the previous step)</p> <p>I_{rated} = Motor rated current (from motor nameplate)</p> <p>Example: $\frac{2.5 * 100}{4.2} = 60$</p>	<p>Press the  key four times.</p> <p>Press the  key four times.</p> <p>Press the  key.</p> <p>Use the  &  keys until the number in the display matches calculated no-load current.</p> <p>Press the  key.</p>	   ⁽¹⁾ 
<p>This completes the startup. Make further programming changes as required.</p>	<p>Press the  key to get out of the programming mode.</p>	 ⁽¹⁾

(1) The number in the display may be different than shown.

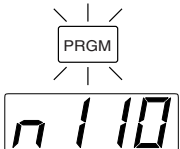
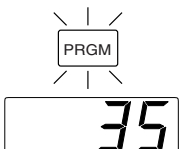
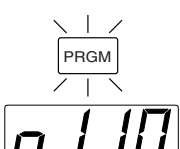
(2) Motor synchronous speed can be calculated using the following formula:

$$\text{synch. speed} = \frac{120 \times \text{motor rated frequency}}{\text{number of motor poles}}$$

For 60 Hz Rated Motors	
Poles	Synchronous Speed
2	3600 RPM
4	1800 RPM
6	1200 RPM
8	900 RPM

2.3 V/f STARTUP PROCEDURE

IMPORTANT

2-wire or 3-wire sequence selection must be made prior to any other adjustments (Parameter n001).

Table 2-2. V/f Startup Procedure

















DESCRIPTION	KEY SEQUENCE	DIGITAL OPERATOR DISPLAY
<p>Set the highest parameter access level. This will allow all parameters to be viewed and set.</p>	<p>Press  key until the  LED is lit on the digital operator.</p> <p>Press .</p> <p>Press  three times.</p> <p>Press .</p>	<p> n001</p> <p> 1</p> <p> 4</p> <p> n001</p>
<p>Set drive for V/f control. This is accomplished by setting n002 = 0</p>	<p>Press  then .</p> <p>Use the  &  keys to set a "0" in the display.</p> <p>Then press .</p>	<p> 1</p> <p> 0</p> <p> n002</p>

Table 2-2. V/f Startup Procedure - Continued











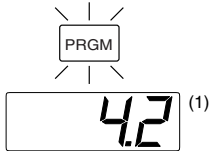

DESCRIPTION	KEY SEQUENCE	DIGITAL OPERATOR DISPLAY
<p>Set motor rated current. (This can be obtained from the nameplate of the motor.)</p>	<p>Press and hold  until n036 is displayed on the digital operator.</p> <p>Then press .</p> <p>Use the  &  keys until the number in the display matches the motor rated current.</p> <p>Then press .</p>	 
<p>Set the V/f pattern. Parameters n011 through n017 set the V/f pattern. Table 5-4 in section 5.27 lists recommended V/f patterns. The numbers in parentheses shown in the example below are for a 460V / 60 Hz variable torque application (fan or pump).</p>		
<p>Set Parameter n011- Maximum output frequency. (60.0 Hz)</p>	<p>Press and hold  until n011 is displayed on the digital operator.</p> <p>Then press .</p> <p>Use the  &  keys until the desired number is in the display.</p> <p>Then press .</p>	  

Table 2-2. V/f Startup Procedure - Continued





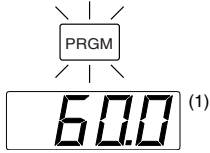



















DESCRIPTION	KEY SEQUENCE	DIGITAL OPERATOR DISPLAY
<p>Set Parameter n012- Voltage Max. (460.0 V)</p>	<p>Press  then .</p> <p>Use the  &  keys until the desired number is in the display.</p> <p>Then press .</p>	<p> 400.0⁽¹⁾</p> <p> 460.0⁽¹⁾</p> <p> n0 12</p>
<p>Set Parameter n013- Frequency at max. voltage point (motor rated frequency) (60.0 Hz)</p>	<p>Press  then .</p> <p>Use the  &  keys until the desired number is in the display.</p> <p>Then press .</p>	<p> 60.0⁽¹⁾</p> <p> 60.0⁽¹⁾</p> <p> n0 13</p>
<p>Set Parameter n014- Frequency - Midpoint (30.0 Hz)</p>	<p>Press  then .</p> <p>Use the  &  keys until the desired number is in the display.</p> <p>Then press .</p>	<p> 15⁽¹⁾</p> <p> 30.0⁽¹⁾</p> <p> n0 14</p>

Table 2-2. V/f Startup Procedure - Continued











































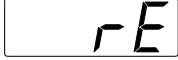

DESCRIPTION	KEY SEQUENCE	DIGITAL OPERATOR DISPLAY
<p>Set Parameter n015- Voltage - Midpoint (80.4 V)</p>	<p>Press  then .</p> <p>Use the  &  keys until the desired number is in the display.</p> <p>Then press .</p>	  ⁽¹⁾   ⁽¹⁾  
<p>Set Parameter n016- Frequency - Minimum (1.5 Hz)</p>	<p>Press  then .</p> <p>Use the  &  keys until the desired number is in the display.</p> <p>Then press .</p>	  ⁽¹⁾   ⁽¹⁾  
<p>Set Parameter n017- Voltage - Minimum (18.4 V)</p>	<p>Press  then .</p> <p>Use the  &  keys until the desired number is in the display.</p> <p>Then press .</p>	  ⁽¹⁾   ⁽¹⁾  

Table 2-2. V/f Startup Procedure - Continued

DESCRIPTION	KEY SEQUENCE	DIGITAL OPERATOR DISPLAY
<p>Prepare to test run the drive from the Digital Operator. Motor should be disconnected from the load.</p> <p>This will set the drive into the “Local” mode, and bring up the motor current display.</p>	<p>Press  several times until the “LO/RE” LED is lit.</p> <p>Press the  key once.</p> <p>Display the drive’s output current by pressing  four times. Turn the Digital Operator Pot all the way to the left (counter-clockwise).</p>	     
<p>Test run the drive from the Digital Operator</p>	<p>WARNING: The next key press will cause the motor to turn! Take appropriate safety precautions!</p> <p>Press the  key then slowly turn the Digital Operator Pot to the right about 1/4 of a turn. The display on the drive will show the actual motor amps.</p> <p>Operation checkpoints:</p> <ul style="list-style-type: none"> • Motor rotates smoothly • Motor rotates in correct direction. (If motor does not rotate in the proper direction, stop the motor and remove power from the Drive. Switch motor connections T1 (U) and T2 (V) at the Drive to change direction). • Motor has no abnormal vibration or noise. • Acceleration and deceleration are smooth. • Unit is not overloaded. (Displayed current does not exceed drive rated current). <p>Press the  key.</p>	  ⁽¹⁾
<p>This completes the startup. Make further programming changes as required.</p>		

⁽¹⁾ The number in the display may be different than shown.

Section 3. OPERATION AT LOAD

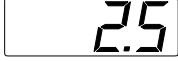
After completing the start-up, and programming of constants, turn off the AC main circuit power. Make additional wiring connections required for the external control functions selected by the constant programming. Connect the driven machine to the motor. Verify that the driven machine is in running condition, and that no dangerous conditions exist around the drive system.

CAUTION

- Before applying a RUN command to the Drive, verify that the motor is stopped.
- **NEVER** use a motor whose full-load amps exceeds the Drive rating.
- When starting and stopping the motor, use the operation signals (RUN/STOP, FWD/REV), NOT a magnetic contactor on the power supply side.

Run the motor under load with control by the Digital Operator using the same procedure as for the Initial Start-up. If the Digital Operator is used in combination with external commands or external commands only are used, the procedure must be altered accordingly.

Section 4. DIGITAL OPERATOR

4.1 GENERAL

All functions of the Drive are accessed using the Digital Operator. In addition to controlling motor operation, the operator can enter information into the Drive memory to configure the Drive's application, by using the Function LEDs.

4.2 DIGITAL OPERATOR

A. Digital Operator Description

The Digital Operator has a 4-digit LED display. Both numeric and alpha-numeric data can appear on the display. Indicators and keys on the Digital Operator are described in Figure 4-1.

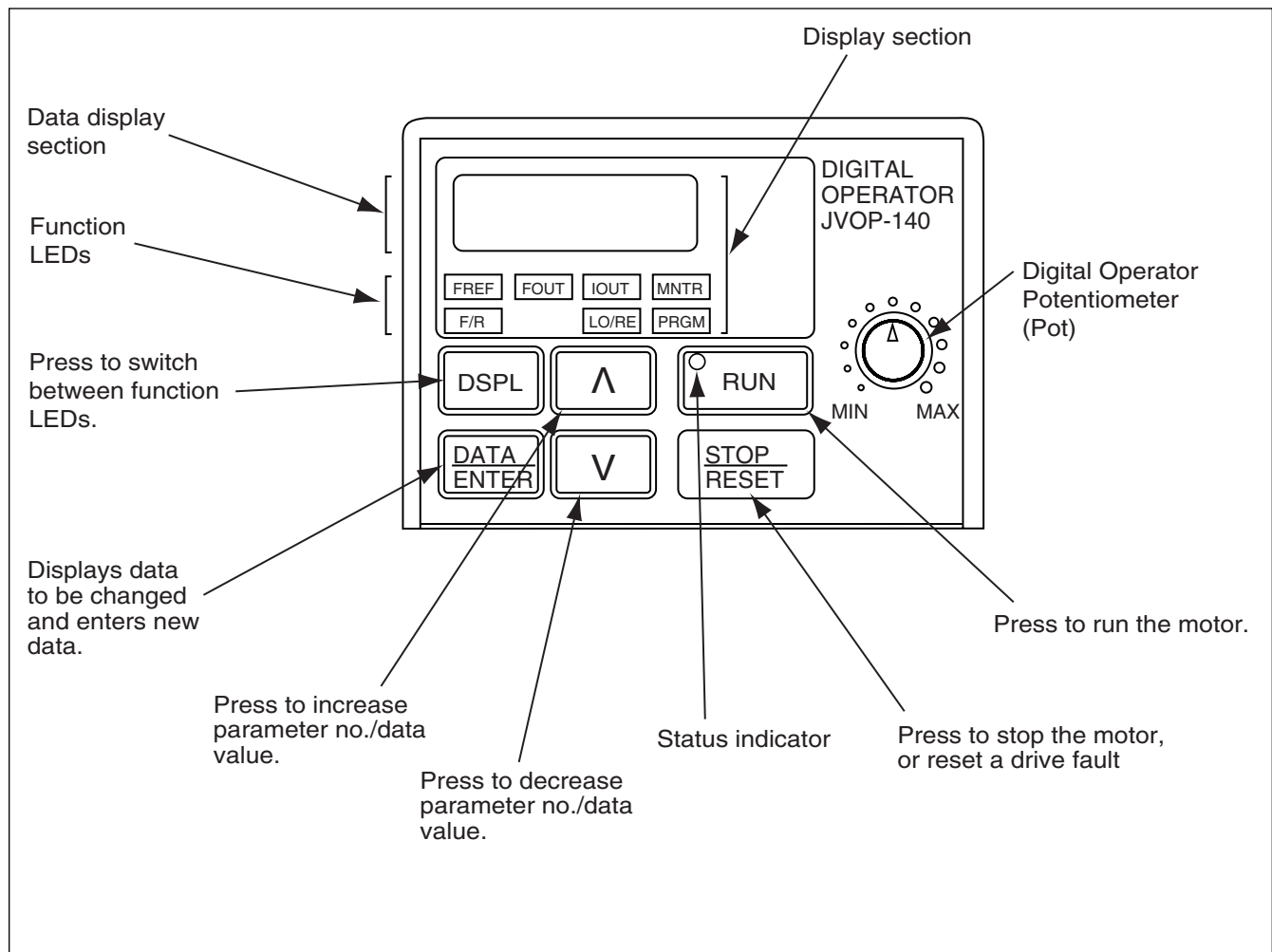

(1) Not available on V74X.

NOTE:

The JVOP-140 is the standard digital operator for the V7. The Digital Operator of the V74X does not have a potentiometer (pot) and cannot be removed. All functions will be identical with the exception of the pot and copy function (section 5-29).

B. Description of Function LEDs

By pressing the **DSPL** key on the Digital Operator, the operator can step to each of the seven Function LEDs and its associated display/setting function:

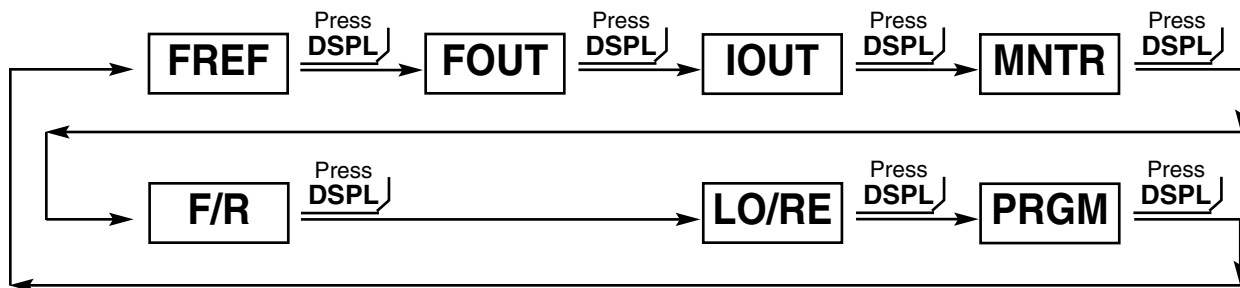

- FREF** — **Frequency Reference Setting**
Sets/Displays the Drive operation speed (Hz).

- FOUT** — **Output Frequency Monitor**
Displays the output frequency (Hz) at which the Drive is currently operating. This is a **monitor only** function; the operator cannot change the displayed value by use of the keypad.

- IOUT** — **Output Current Monitor**
Displays the level of output current (Amps) that the Drive is currently producing. This is a **monitor only** function; the operator cannot change the displayed value by use of the keypad.

- MNTR** — **Monitor Selection**
Pressing **ENTER** allows access to the various Monitor parameters, **U-01** through **U-10**. These are monitor only functions; the operator cannot change the displayed value. Accessible during run command. See section 4.4. for complete listing of all monitor parameters.

- F/R** — **FWD/REV Run Selection**
Sets the rotation direction of the motor when a Run command is given by the Digital Operator keypad. Display of **For** = forward run, **rEu** = reverse run.

- LO/RE** — **Local / Remote Selection**
This toggles between the Local (Digital Operator) and Remote (set by parameters n003 & n004) modes of operation. This affects both the start/stop functions, as well as the frequency reference. Local / Remote status cannot be changed using this LED when a multi-function input terminal is set for Local/Remote (n050 through n056 set for "17").

- PRGM** — **Parameter Programming**
Selects or reads data using parameter number (**nXXX**). Data is displayed by pressing the **ENTER** key, and can be changed by pressing the "up arrow" or "down arrow" keys. Any changes can be saved by again pressing the **ENTER** key. Pressing the **DSPL** key exits the Programming mode.

4.3 STATUS INDICATOR LEDs

There are two indicator LEDs on the front of the Drive. The drive status is indicated by various combinations of ON, Blinking, and OFF conditions of these two LEDs:

CONDITION	(Green) ○ RUN	(Red) ○ ALARM
Operation Ready (during stop) Ramp to Stop (during decel)	Blinking Long Blinking	Off Off
Normal Operation (running) Alarm	On Blinking or ON	Off Blinking
Fault	Off	On

For details of how the status indicator LEDs function during a drive fault, refer to the "TROUBLESHOOTING" SECTION.

4.4 MONITOR DISPLAYS

When using the **Monitor** Function, a variety of information will appear on the Digital Operator display when each of the U-XX (display only) parameters is selected.

PARAMETER U -	MONITORED ITEM	DISPLAY EXAMPLE
01	Frequency reference (Hz)	60.0
02	Output frequency (Hz)	60.0
03	Output current (A)	12.5
04	AC output voltage (V)	230
05	DC Bus voltage (VPN)	325
06	Input terminal status	<i> </i> (1)
07	Output Terminal status	<i> </i> (2)
08	Motor Torque (%) (Open loop vector only)	72
09	Fault record (last 4 faults) (3)	oC
10	Software number XXXX	0024
11	Output Power (KW)	99.9
15	Data reception error	<i> </i> (4)
16	PID Feedback (%)	35.0
17	PID Input (%)	100
18	PID Output (%)	75.5

(1) Actual display appearance:

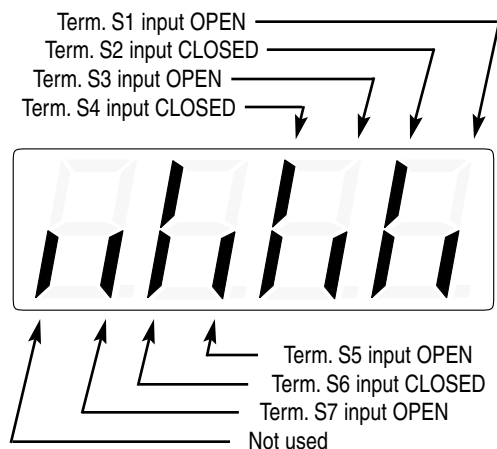

(2) Actual display appearance:

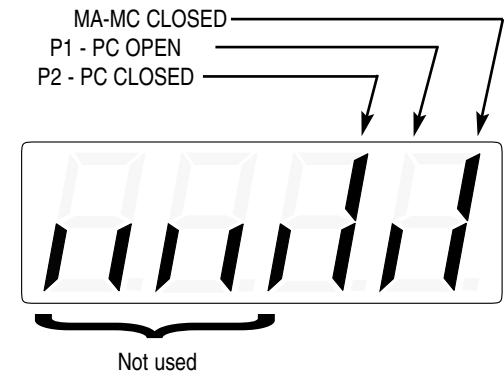

(3) See section 6 for viewing of fault log contents.

(4) Actual display appearance:

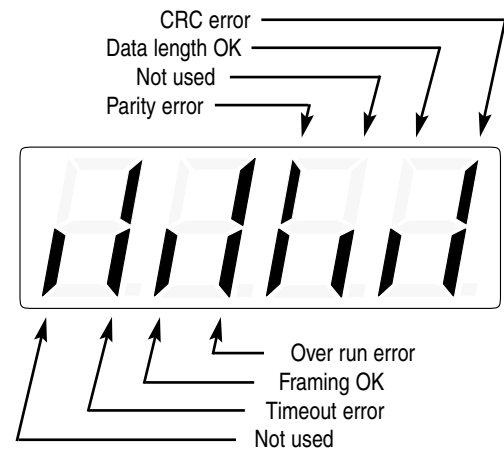

Section 5. PROGRAMMABLE FEATURES

5.1 GENERAL

This section describes features of the Drive which are defined by programmed settings in the various parameters in memory. Since most features use more than one parameter, the descriptions appear in alphabetical order by the function name. In Table 5-1, the functions are grouped into operational categories. To cross reference a particular parameter to the features to which it applies, see the listings in Appendix 1.

Table 5-1. List of Features Defined By Parameters

FUNCTION	PARAGRAPH REFERENCE	PARAMETER(S)
SET-UP		
Initialization (Reset), 2-Wire or 3-Wire	5.21	<i>n001</i>
Volts/Hertz Patterns	5.27	<i>n011 - n017</i>
Thermal Motor Overload Protection	5.25	<i>n036 - n038</i>
Control Method Selection	2.2	<i>n002</i>
Copy Function ⁽¹⁾	5.29	<i>n176, n177</i>
STARTING		
Accel Time	5.2	<i>n018, n019, n021</i>
S-Curve Characteristics	5.3	<i>n023</i>
DC Injection Braking at Start	5.7	<i>n089, n091</i>
STOPPING		
Stopping Method	5.24	<i>n005</i>
Decel Time	5.2	<i>n018, n020, n022</i>
DC Injection Braking at Stop	5.7	<i>n089, n090</i>
SPEED CONTROL		
Frequency Reference, Upper & Lower Limits	5.9	<i>n033, n034</i>
Jog Reference	5.12	<i>n032, n050 - n056</i>
Frequency Reference Selection	5.11	<i>n004, n008, n009</i>
Multi-step Speed Setting	5.11	<i>n004, n024 - n031</i> <i>n050 - n056, n120 - n127</i>
Up/Down Frequency Setting	5.10, 5.18F	<i>n056, n100</i>
Modbus Control	5.14	<i>n003, n004, n151 - n157</i>
PID Control	5.28	<i>n128 - n138, n163, n164</i>
REVERSE		
Reverse Run Disabled	Table A1-1	<i>n006</i>
Critical Frequency Rejection	5.6	<i>n083 - n086</i>
Carrier Frequency	5.5	<i>n080, n175</i>
Speed Search	5.18D, E	<i>n050 - n056</i>
Speed Coincidence	5.19	<i>n057 - n059, n095</i>
Slip Compensation	5.22	<i>n036, n106, n110 - n113</i>
RUNNING IMPROVEMENTS		
Torque Compensation	5.26	<i>n103 - n105, n109</i>
Stall Prevention	5.23	<i>n092 - n094, n115, n116</i>
Energy Saving	5.31	<i>n139 - n146, n158 - n162</i>
PROTECTIVE FEATURES		
Momentary Power Loss Ride-thru	5.16	<i>n081</i>
Auto Restart	5.4	<i>n082</i>
Overtorque/Undertorque Detection	5.20	<i>n057 - n059, n096 - n099</i>
Miscellaneous Protective Functions	5.15	<i>n007, n010</i>
DRIVE CONTROLS, INPUT		
Analog Frequency Reference Bias and Gain	5.8	<i>n060, n061</i>
Multi-function Analog Inputs	5.11	<i>n068 - n079, n149</i>
Multi-function Input Terminals	5.18	<i>n050 - n056</i>
External Fault Terminals	5.18	<i>n050 - n056</i>
DRIVE OUTPUT		
Multi-function Output Terminals	5.19	<i>n057 - n059</i>
Analog Monitor Output (Multi-function)	5.17	<i>n066, n067</i>
Pulse Monitor Output	5.17	<i>n150</i>

⁽¹⁾ Not available on V74X

5.2 ACCEL/DECEL TIME

A. **n019** : Accel Time 1
n020 : Decel Time 1

Factory setting (each): **10.0** seconds

Range (each): 0.00 to 6000.0 seconds

n021 : Accel Time 2
n022 : Decel Time 2

Factory setting (each): **10.0** seconds

Range (each): 0.00 to 6000.0 seconds

n041 : Accel Time 3
n042 : Decel Time 3

Factory setting (each): **10.0** seconds

Range (each): 0.00 to 6000.0 seconds

n043 : Accel Time 4
n044 : Decel Time 4

Factory setting (each): **10.0** seconds

Range (each): 0.00 to 6000.0 seconds

The drive incorporates four sets of individually programmable acceleration and deceleration times. Four acceleration and deceleration times can be selected if two Multi-Function Input Terminals (**n050** to **n056**) are set to '11' (accel/decel time 1) and '27' (accel/decel time 2).

B. **n050** thru **n056** : Multi-function Inputs
(Term. S1 thru S7)

Data **11** : Accel/Decel Time Selection 1

Data **27** : Accel/Decel Time Selection 2

The following table shows which acceleration and deceleration times are selected by each combination of accel/decel time select 1 (**n050** thru **n056** = 11) and accel/decel time select 2 (**n050** thru **n056** = 27).

Accel/decel time Select 1 (terminal S1 thru S7)	Accel/decel time Select 2 (terminal S1 thru S7)	Acceleration time	Deceleration time
OPEN	OPEN	Acceleration time 1 n019	Deceleration time 1 n020
CLOSED	OPEN	Acceleration time 2 n021	Deceleration time 2 n022
OPEN	CLOSED	Acceleration time 3 n041	Deceleration time 3 n042
CLOSED	CLOSED	Acceleration time 4 n043	Deceleration time 4 n044

C. **n018** : Accel Time Setting Unit

Factory setting: **0**

Range : 0 = 0.1 seconds
1 = 0.01 seconds

In addition to determining the setting resolution, this parameter controls the range of **n019** thru **n022**; if the resolution is 0.01 sec., the range is 0.00 to 600.00 sec. If the resolution is set to 0.1 sec., the range is 0.0 to 6000.0 sec.

5.3 ACCEL/DECEL: S-CURVE CHARACTERISTICS

n023 : S-Curve Selection

Factory setting: **0**

Range: 0 to 3

Setting of this parameter determines the S-curve (starting) characteristics of the acceleration ramp.

- 0** = S-curve disabled
- 1** = S-curve of 0.2 seconds
- 2** = S-curve time of 0.5 seconds
- 3** = S-curve time of 1.0 seconds

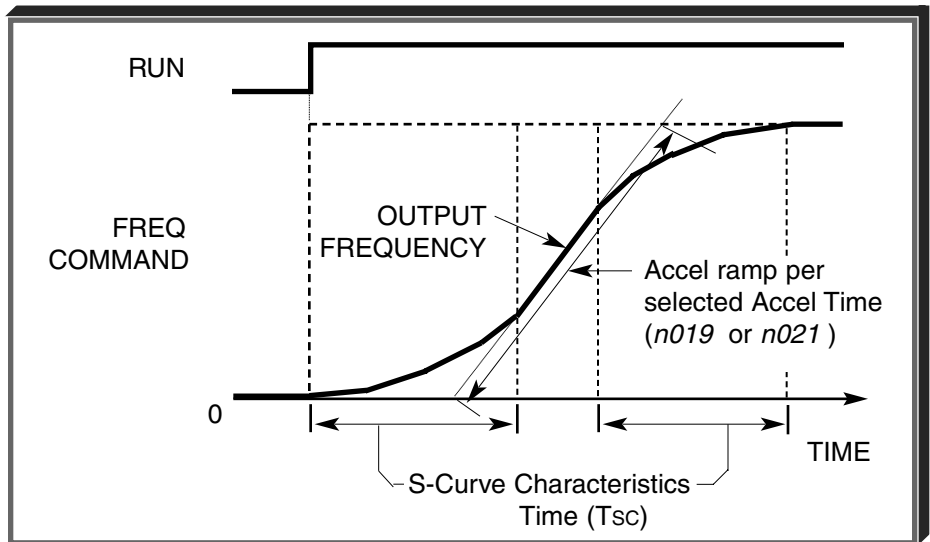

NOTE: Actual accel time = Set accel time + (2 * S-curve selection)

Actual decel time = Set decel time + (2 * S-curve selection)

The following figure shows FWD/REV switching and acceleration & deceleration to a stop with S-curve active.

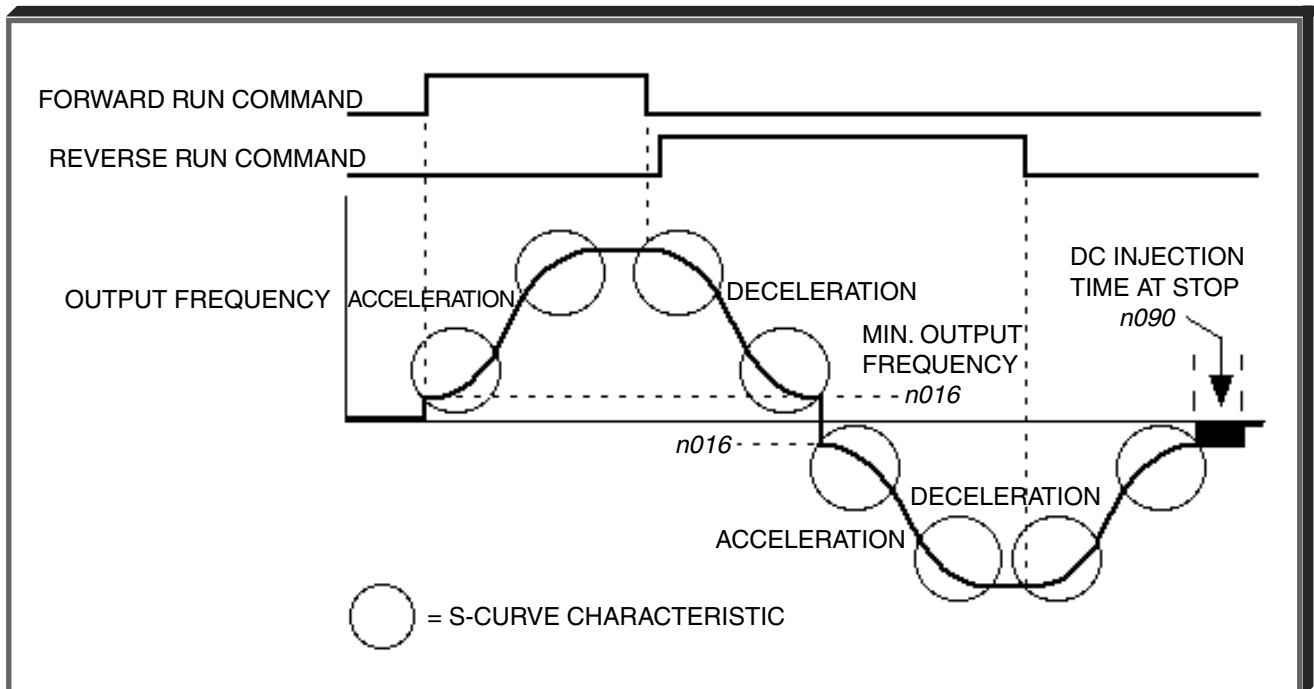

5.4 AUTO-RESTART

n082 : Number of Auto-Restart Attempts

Factory setting: **0**

Range: 0 - 10

When a fault occurs during operation, the Drive can be programmed for an auto-restart operation to automatically reset the fault. Auto-restart operation will use the number of reset attempts set in this parameter, up to the maximum of 10. When set to " 0 ", no auto-restarts will be attempted.

Fault contact will not actuate (change state) during auto-restart attempts.

- The following faults can be automatically reset:
 - oC: Overcurrent
 - ou: Overvoltage (OV)
- The number of restart attempts available will be reset to the **n082** setting when:
 1. 10 minutes has elapsed without a fault occurring.
 2. The **RESET** key, or external Fault Reset push button, is pressed.
 3. Power is removed from the Drive.

5.5 CARRIER FREQUENCY

n080 : Carrier Frequency

Factory Setting: **3**

Range: 1 to 4; 7 to 9

The relationship between output frequency and carrier frequency is determined from the set value of **n080** .

- (a) For constant carrier frequency, set to " 1 ", " 2 ", " 3 ", " 4 " .
- (b) For synchronous mode, set **n080** to " 7 ", " 8 ", or " 9 ". These setting values establish carrier frequencies of 12f, 24f, or 36f, respectively.

n080 SETTING	CARRIER FREQUENCY(kHz)		SLOPE (= $\frac{F_c}{F_o}$)	OUTPUT FREQUENCY(Hz)		MODE
	Maximum(F_{cMAX})	Minimum(F_{cMIN})		F1	F2	
1	2.5	2.5	0	NA	NA	CONSTANT
2	5.0	5.0	0	NA	NA	
3	7.5	7.5	0	NA	NA	
4	10.0	10.0	0	NA	NA	
7	2.5	1.0	12	83.3	208.3	SYNCHRONOUS
8	2.5	1.0	24	41.6	104.1	
9	2.5	1.0	36	27.7	69.4	

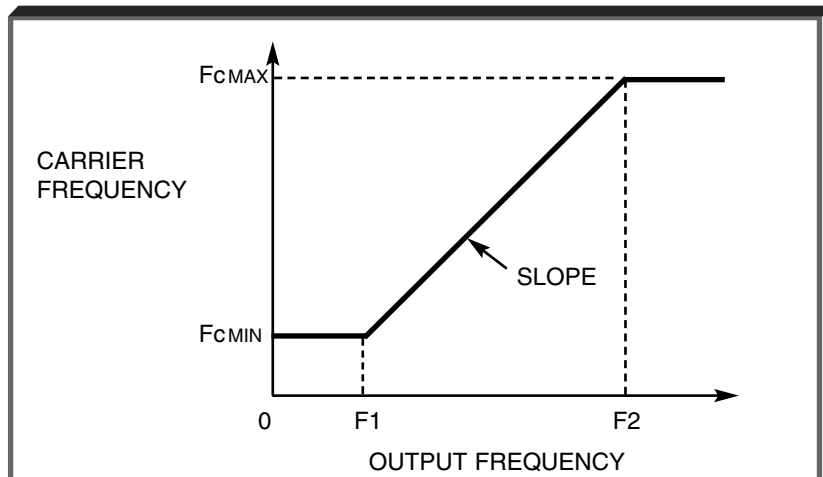

DRIVE DERATING FOR HIGHER CARRIER FREQUENCY

Setting carrier frequency to a value higher than its factory setting requires derating of the drive's output current - refer to the following table:

Rated input	Old Drive Model No.	New Drive Model No. CIMR-V7A*	Rated Output Current (A)	n080		Derated Output Current (A) ⁽²⁾
				Factory Setting	Frequency (kHz)	
230V	MVA001 MVA002	20P10 20P20	0.8 1.6	4 4	10 10	No Derate
	MVA003 MVA005	20P40 20P70	3.0 5.0	4 4	10 10	
	MVA008 MVA011 MVA017	21P50 22P20 23P70	8.0 11.0 17.5	3 3 3	7.5 7.5 7.5	7.0 10.0 16.5
	MVA025 MVA033	23P71 23P72	25.0 33.0	3 3	7.5 7.5	23.0 30.0
460V	MVB001 MVB002	40P20 40P40	1.2 1.8	3 3	7.5 7.5	1.0 1.6
	MVB003 MVB005 MVB009	40P70 41P50 43P70	3.4 4.8 8.6	3 3 3	7.5 7.5 7.5	3.0 4.0 No Derate
	MVB015 MVB018	43P70 43P70	14.8 18.0 / 21.0 ⁽¹⁾	3 3	7.5 7.5	14.0 17.0 / 19.8

(1) Output current rating of 21.0A applies only to V74X drive.

(2) Derated Output Current values are the maximum currents available with a carrier frequency **n080** setting of "4" (10kHz).

Carrier frequency should be decreased as the distance between the drive and the motor increases, to reduce capacitive coupling in the motor leads.

- For wiring distances greater than 100m (328 ft.), **n080** should be set to 5 kHz (data " 2 ") or less.

n175 : Reduce carrier at low speed selection

Factory Setting: 0

Range: 0 or 1

SETTING	DESCRIPTION
0	Disabled
1	Carrier frequency reduced to 2.5 KHz

When **n175** is enabled (= "1"), the carrier frequency will automatically be reduced to 2.5 kHz, regardless of the setting of **n080**, whenever the output frequency is at or below 5 Hz AND the output current is above 110% of drive rated current.

5.6 CRITICAL FREQUENCY REJECTION

- A. **n083** : Prohibited Frequency 1
n084 : Prohibited Frequency 2
n085 : Prohibited Frequency 3

Factory setting (each): **0.00**

Range (each): 0.00 to 400.0 Hz

These parameters allow programming of up to three prohibited frequency points for eliminating problems with resonant vibration of the motor/machine. This feature does not actually eliminate the selected frequency values, but will accelerate and decelerate the motor through the prohibited bandwidth.

- B. **n086** : Prohibited Frequency Deadband

Factory setting: **0.00**

Range: 0.00 to 25.50 Hz

This parameter determines the width of the deadband around each selected prohibited frequency point.

EXAMPLE:

Vibration encountered between 30.00 and 36.00 Hz.

SOLUTION: Set **n083** to " 33.00 ". This is the center of the problem frequency band.

Set **n086** to " 3.00 ". This will cause the Drive to reject all frequency command values between 30.00 and 36.00 Hz.

A frequency command in the deadband will be converted to the bottom value of the deadband, e.g. a command of 33.00 Hz would result in a run frequency of 30.00 Hz.

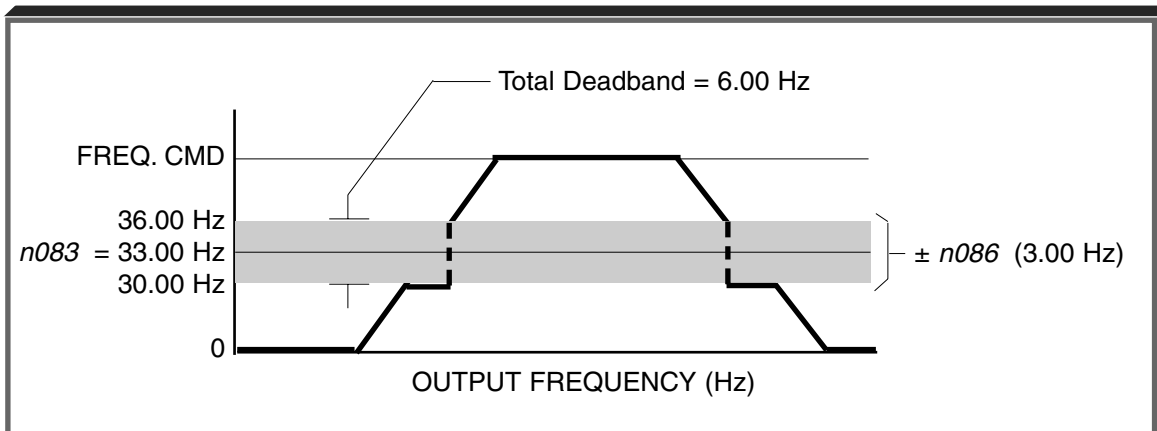

NOTE: $n083 > n084 > n085$ - The highest prohibit frequency required needs to be in $n083$. The next highest prohibit frequency needs to be in $n084$, and the lowest prohibit frequency needs to be in $n085$.

5.7 DC INJECTION BRAKING

n016 : Minimum Frequency

Range: 0.1 to 10.0 Hz

n089 : DC Injection Braking Current
(% of Drive Rated Current)

Factory setting: **50** %

Range: 0 to 100 %

n090 : DC Injection Time at Stop

Factory setting: **0.5** sec

Range: 0.0 to 25.5 sec

n091 : DC Injection Time at Start

Factory setting: **0.0** sec

Range: 0.0 to 25.5 sec

DC injection can be used to stop a motor whose rotational direction is uncertain at start-up, or to help stop a coasting motor.

With ramp to stop enabled (**n005** = " 0 "), after a STOP command is received the Drive controls motor deceleration according to the Decel Time setting, until output frequency reaches the DC injection braking start frequency (or Minimum Frequency, **n016**). Then the Drive output is turned off and DC injection current is applied to the motor. The effective DC injection time and current should be set to provide adequate stopping without excessive motor heating. The DC injection voltage is determined by the DC injection braking current and motor impedance.

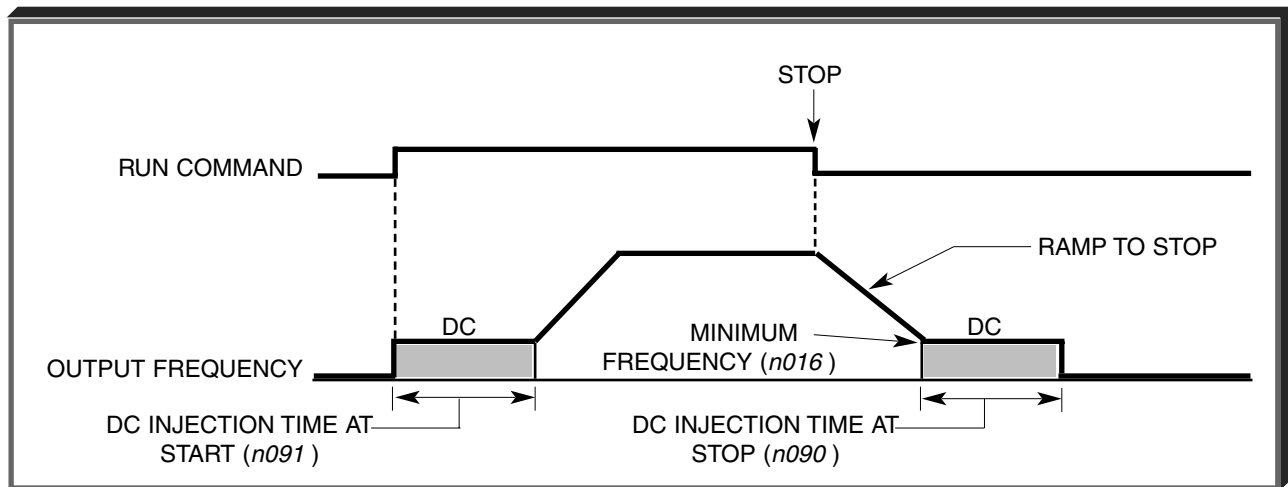

DC Braking Sequence

5.8 FREQUENCY REFERENCE BIAS/GAIN (ANALOG)

n060 : Analog Frequency Reference Gain

Factory setting: **100** %

Range: 0 to 255 %

Sets the auto-speed frequency command gain, in increments of 1%.

n061 : Analog Frequency Reference Bias

Factory setting: **0** %

Range: -100 to 100 %

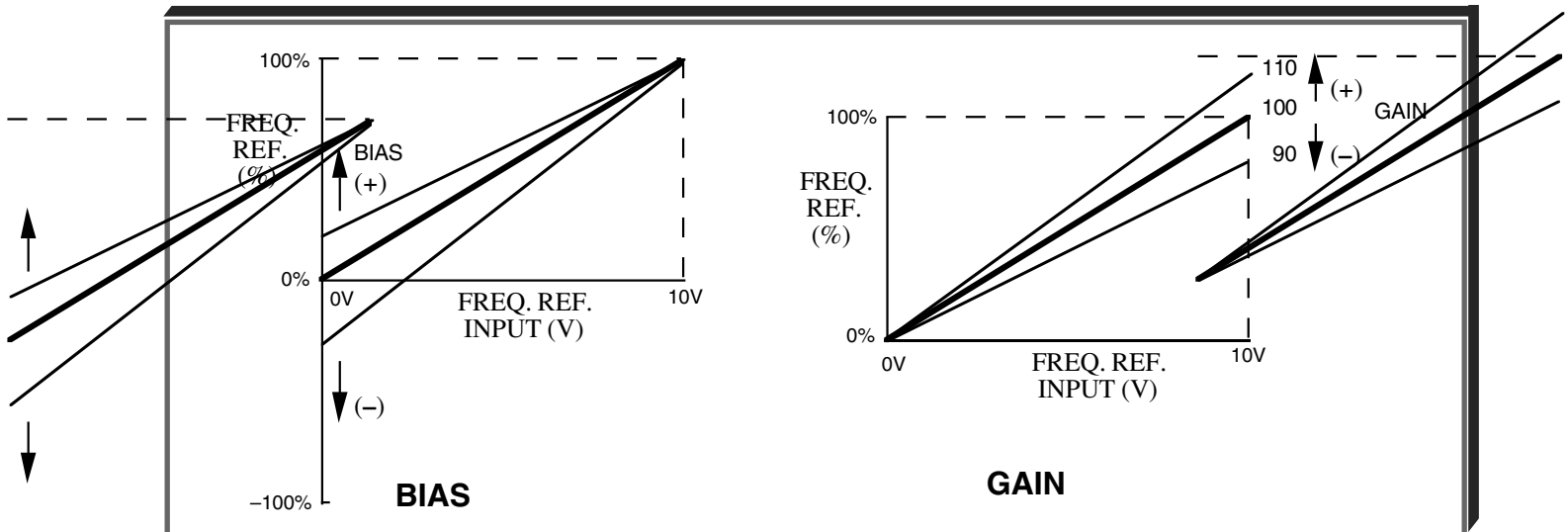

ADJUSTMENT PROCEDURE:

1. With no input, adjust Bias (**n061** setting) until an output of 0.0 Hz is obtained.
2. With full scale input, adjust Gain (**n060** setting) until an output of 60.0 Hz (or other desired max. output frequency) is obtained.

NOTE: Follow the same adjustment procedure for other desired frequency setpoints.

For inverse-acting frequency reference

1. Begin with **n060** & **n061** settings as shown below.
2. Fine tune as indicated above.

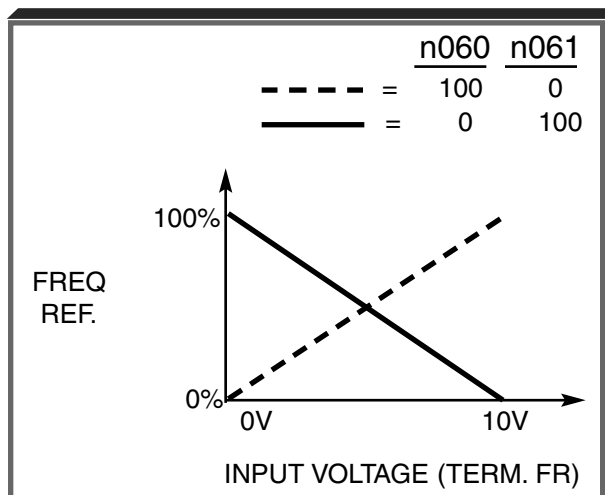

5.9 FREQUENCY REFERENCE UPPER & LOWER LIMITS

n033 : Frequency Reference Upper Limit

Factory setting: **100** %

Range: 0 to 110 %

n034 : Frequency Reference Lower Limit

Factory setting: **0** %

Range: 0 to 110 %

These two parameters set the range for the frequency command signal. Each is set, in increments of 1%, as a percentage of maximum frequency (Fmax; **n011**) as established by either the selected standard V/f pattern or custom V/f pattern.

NOTE: All references are affected by the upper and lower limit points.

EXAMPLE:

n011 = " 60 " Hz (100%)

n033 = " 80 " % = 48Hz – Max. speed

n034 = " 10 " % = 6Hz – Min. speed

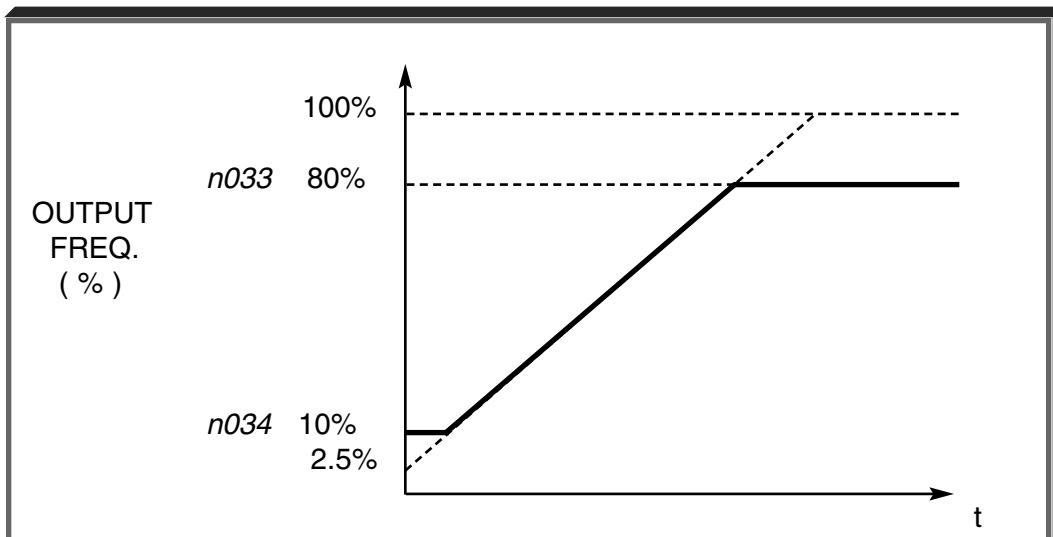

NOTE: n033 must be set to a higher value than n034.

5.10 FREQUENCY REFERENCE RETENTION

n100 : Up/Down Hold Memory

Factory setting: **0**

Range: 0 or 1

Used with the Up/Down command. To retain the held frequency reference when a stop command is issued or when power is removed, set **n100** to " 1 ".

Setting	Description
0	Not retained
1	Held reference retained

Note: Frequency reference value must remain unchanged for a minimum of 5 seconds to be retained.

5.11 FREQUENCY REFERENCE SELECTION

The Drive allows selection of up to twenty-three frequency references. Three are analog inputs, sixteen are digital presets (selected with multi-function inputs), one is a jog input, one is a pulse train input, one is via serial communications (MODBUS), and one is from an option cable (see paragraph 5.32).

A. Frequency Reference via Analog Input

In order to set the Drive so the frequency reference comes from the analog input, set parameter **n004** as shown in the table below:

PARAMETER	SETTING	DESCRIPTION
n004	2	Sets terminal FR for a voltage input (0 to 10V) Set SW2 switch 2 to Off ⁽¹⁾
	3	Sets terminal FR for a current input (4 to 20mA) Set SW2 switch 2 to On ⁽¹⁾
	4	Sets terminal FR for a current input (0 to 20mA) Set SW2 switch 2 to On ⁽¹⁾

⁽¹⁾ SW2 consists of two separate slide switches and can be found just above the upper row of control circuit terminals. The switch towards the bottom (labeled "2") connects a 250Ω resistor from terminal FR to FC when set to the "on" position (to the right). NOTE: All power must be removed from the Drive before SW2 can be set.

B. Frequency Reference via Digital Presets

In order to set the Drive so the frequency reference comes from the digital presets, the following parameters need to be set:

PARAMETER	SETTING	DESCRIPTION
n024 thru n031	User Set	Eight Frequency References
n050 thru n056	6, 7, 8, and/or 9	Sets the multi-function inputs so selection of the various references is possible with contact closures.
n120 thru n127	User Set	Eight More Frequency References

Depending upon how many preset references are required determines the actual settings of **n050** thru **n056**. Several examples are listed below.

5.11 FREQUENCY REFERENCE SELECTION

Continued

Example 1 - Four preset references

Programming: **n054 = 6** and **n055 = 7**

DIGITAL PRESET	S6	S5
Selectable Reference ⁽²⁾	Open	Open
n025	Open	Closed
n026	Closed	Open
n027	Closed	Closed

Example 2 - Eight preset references

Programming: **n054 = 6**, **n055 = 7** and **n056 = 8**

DIGITAL PRESET	S7	S6	S5
Selectable Reference ⁽²⁾	Open	Open	Open
n025	Open	Open	Closed
n026	Open	Closed	Open
n027	Open	Closed	Closed
n028	Closed	Open	Open
n029	Closed	Open	Closed
n030	Closed	Closed	Open
n031	Closed	Closed	Closed

Example 3 - Sixteen preset references

Programming: **n053 = 6**, **n054 = 7**, **n055 = 8** and **n056 = 9**

DIGITAL PRESET	S7	S6	S5	S4
Selectable Reference ⁽²⁾	Open	Open	Open	Open
n025	Open	Open	Open	Closed
n026	Open	Open	Closed	Open
n027	Open	Open	Closed	Closed
n028	Open	Closed	Open	Open
n029	Open	Closed	Open	Closed
n030	Open	Closed	Closed	Open
n031	Open	Closed	Closed	Closed
n120	Closed	Open	Open	Open
n121	Closed	Open	Open	Closed
n122	Closed	Open	Closed	Open
n123	Closed	Open	Closed	Closed
n124	Closed	Closed	Open	Open
n125	Closed	Closed	Open	Closed
n126	Closed	Closed	Closed	Open
n127	Closed	Closed	Closed	Closed

⁽²⁾ The Selectable Reference is chosen from the following list:

REFERENCE SOURCE	PROGRAMMING
Digital Operator Speed Pot	n004 = 0
Digital Preset Reference parameter n024	n004 = 1
Analog Input Terminal FR	n004 = 2, 3, or 4
Pulse Train Reference	n004 = 5
Serial Communications	n004 = 6

C. Jog Reference - See paragraph 5.12

5.11 FREQUENCY REFERENCE SELECTION

Continued

D. Frequency Reference via Pulse Train Input

In order to set the Drive so the frequency reference comes from a pulse train, set the following parameters.

PARAMETER	SETTING	DESCRIPTION
n004	5	Sets reference source as a pulse train at terminals RP & FC
n149	User Set	Sets the input scaling for the pulse train input

Pulse Source Specifications

- Low-level voltage: 0.8V or less
- High-level voltage: 3.5 to 32V
- Duty Cycle: 30 to 70% - high
- Pulse Frequency: 0 to 30 kHz

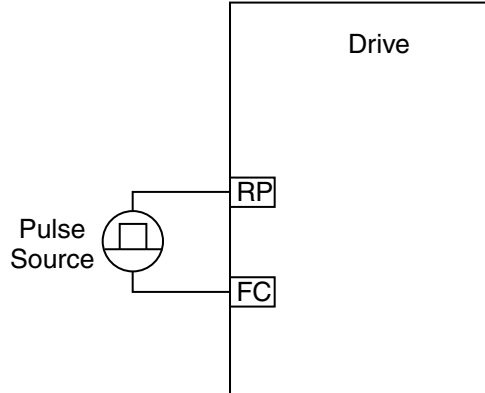

n149 : Pulse Train Input Scaling

Factory Setting: 2500
Range: 100 to 3000 (x 10 Hz)

This parameter scales the incoming frequency on terminal RP by using the following equation

$$\text{Frequency reference} = \frac{\text{Pulse Source Frequency} \cdot n011}{n149 * 10}$$

E. Frequency Reference via Serial Communications - See paragraph 5.14

5.12 JOG REFERENCE

n032 : Jog Reference

Factory setting: **6.00** Hz

Range: 0.00 to 400.0 Hz

n050 thru **n056** : Multi-function Inputs
(Term. S1 - S7)

Data **10** : Jog Selection

When jog operation is selected (by external Jog and Run signals), the Drive output will ramp to the output level set by this parameter.

When an external Jog signal is present, it will override the existing operation mode and the Drive will ramp to the level set by this parameter.

EXAMPLE:

OPERATION BY REMOTE SIGNAL INPUT (RUN & JOG)

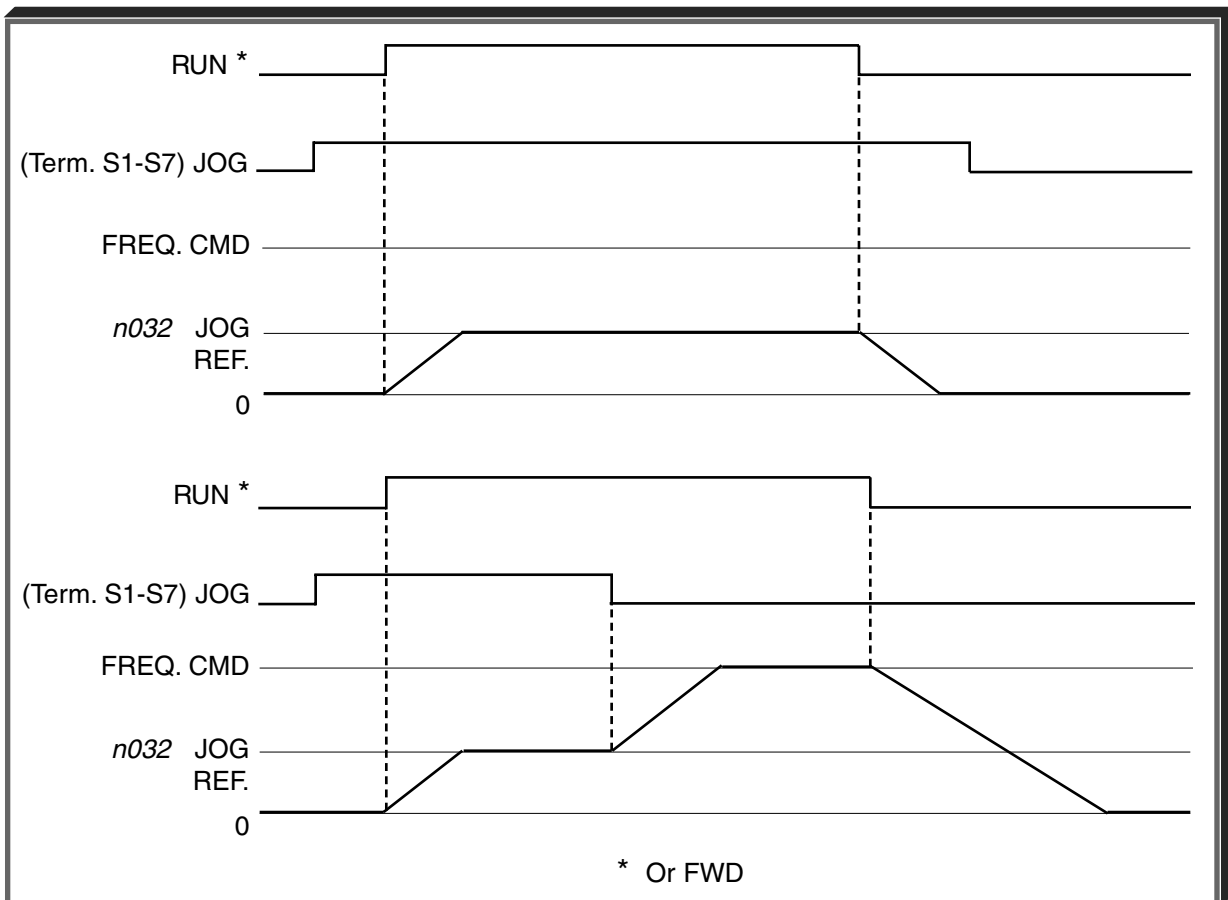

Also see descriptions of **MULTI-FUNCTION INPUT TERMINALS**, paragraph 5.18.

5.13 LOCAL/REMOTE REFERENCE & SEQUENCE SELECTION

The Drive has the ability to have either a local or a remote reference and sequence selection.



Local - Run and stop functions are controlled by the buttons on the digital operator (**n007**). The frequency reference can come from a digital preset reference (**n024 & n009**) or the digital operator pot (**n008**).

Remote - Run and stop functions are determined by parameter **n003**. The frequency reference is determined by parameter **n004**.

Switching between local and remote is accomplished either by the LO/RE LED on the digital operator or by the use of a multi-function input terminal programmed to data "17" (see paragraph 5.18A).

n003 : Operation Method Selection

Factory setting: **1**

SETTING	DESCRIPTION
0	Run and stop is controlled by the  and  buttons on the digital operator.
1	Run and stop is controlled by the multi-function input terminals 2-Wire control - Run Forward (n050 is set to a data of "1") Run Reverse (n051 is set to a data of "2") 3-Wire control - Parameter n052 needs to be set to a data of "0" Run is controlled by a momentary closure on terminal S1 Stop is controlled by a momentary open on terminal S2 Forward/Reverse is controlled by terminal S3
2	Run and stop is controlled by serial communications

n004 : Reference Selection



Factory setting: **2**

SETTING	DESCRIPTION
0	Frequency reference is controlled by the digital operator potentiometer.
1	Frequency reference is controlled by a digital preset speed (n024) and is affected by n009 .
2	Frequency reference is controlled by the analog input terminal FR and is 0 - 10V DC
3	Frequency reference is controlled by the analog input terminals FR and is 4 - 20mA
4	Frequency reference is controlled by the analog input terminal FR and is 0 - 20mA
5	Frequency reference is controlled by the Pulse Train Reference terminal RP .
6	Frequency reference is controlled by serial communications.

n007 : Stop Key Function

Factory setting: **0**

Range: 0 or 1

SETTING	DESCRIPTION
0	 key is effective at all times (regardless of programming of n003)
1	 key is effective only when the run/stop command is from the digital operator (n003 = 0)

5.13 LOCAL/REMOTE REFERENCE & SEQUENCE SELECTION

Continued

n008 : Reference Selection - Digital OperatorFactory setting: **0**

Range: 0 or 1



This parameter is only effective when the Drive is in the local mode.

SETTING	DESCRIPTION
0	Frequency reference is controlled by the digital operator potentiometer
1	Frequency reference is controlled by a digital preset speed (n024) and is affected by n009 .

n009 : Frequency Reference Setting Method From Digital OperatorFactory setting: **0**

Range: 0 or 1

This parameter is only effective when the frequency reference is controlled by a digital preset (**n024**).

SETTING	DESCRIPTION
0	key must be pressed in order for the drive to accept the frequency reference.
1	key does not have to be pressed. The Drive responds immediately to the  and  keys.

5.14 MODBUS CONTROL

The Drive can perform serial communication by using a programmable controller (PLC) and MODBUS® protocol. Modbus is composed of one master PLC and 1 to 31 (maximum) slave units (Drives). In serial communication between the master and slaves, the master always starts transmission and the slaves respond to it.

The master communicates with one slave at a time. Address numbers are assigned to each slave in advance, and the master specifies an address to communicate with. The slave which receives the command from the master executes the function, and then responds to the master.

A. Communication Specifications

- Interface : RS-485 & RS-422
- Synchronization : Asynchronous
- Transmission parameters :
 - Baud rate* — Selectable from 2400, 4800, 9600, 19,200 BPS (**n154**)
 - Data length* — Fixed to 8 bits
 - Parity* — Parity / no parity, even / odd selectable (**n155**)
 - Stop bit* — Fixed to 1 bit
- Protocol : Modbus
- Maximum number to units to be connected : 31 units

B. Setting up the Modbus

Terminals S+, S-, R+, and R- are used for modbus communications. A terminating resistor can be enabled between R+ and R- by setting SW2 (1) to “on.” SW2 is found just above the upper row of control circuit terminals. SW2 consists of two separate switches, the switch towards the top (labeled “1”) turns on and off the terminating resistor.

The terminating resistor should only be enabled on the drive farthest away from the master.

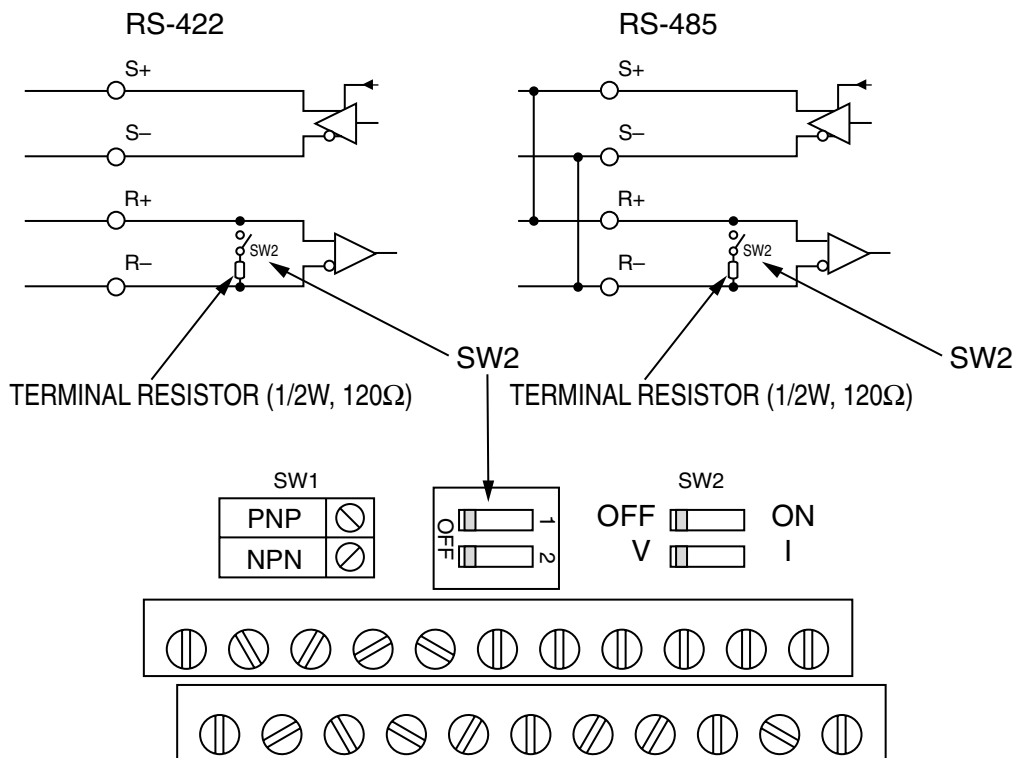

5.14 MODBUS CONTROL

Continued

C. Sending/Receiving Data

Data that can be sent and received are run/stop commands, frequency reference, fault reset, drive status, and setting and reading of parameters.

n003 : Operation Method Selection

Factory setting: 0

Range: 0 to 2

Parameter **n003** selects where the run/stop commands (sequence) will come from. To be able to provide a run command over the Modbus serial communications link, set this to a data of "2."

n004 : Reference Selection

Factory setting: 0

Range: 0 to 6

Parameter **n004** selects where the frequency reference will come from. To be able to provide a frequency reference over the Modbus serial communications link, set this to a data of "6."

n050 thru **n056** : Multi-function Inputs
(Term. S2-S6)

Data 18 : Serial communication/ Digital Operator
--

Selects operation by serial communication or by external terminal. If the status of this command input is changed while the drive is running, the selection is ignored until the next time the drive is stopped.

- Open : Run according to the setting of Operation Method Selection (**n003**) and Reference Selection (**n004**).
- Closed : Run by frequency reference and run command from serial communication.

EXAMPLE: **n003** setting is " 1 ", and **n004** setting is " 2 ".
n056 = 18.

TERMINAL S6 Open: Frequency reference from control circuit terminal FR and run command from control circuit terminals S1, S2.

TERMINAL S6 Closed: Frequency reference and run command from serial communication.

n152 : Modbus Frequency Resolution

Factory setting: **0**

Range: 0 to 3

The frequency resolution from the PLC and in the frequency reference and output frequency monitor (by communication) are selected with this parameter. The output frequency resolution of the Drive is 0.1 Hz. Even if the Modbus resolution is changed to 0.01 Hz in **n152**, the value in the hundredths digit of 0.01 Hz of the received frequency reference is rounded off internally. When 30,000/100% in units of 0.1% is selected, the value is also rounded off.

Setting	Frequency Resolution
0	0.1 Hz
1	0.01 Hz
2	30000/100%
3	0.1%

n153 : Modbus Slave Address

Factory setting: **0**

Range: 0 to 31

Each slave Drive on the same transmission line must be given a unique address.

n154 : Modbus Baud Rate

Factory setting: **2**

Range: 0 to 3

Selects the baud rate, as indicated by the following table:

Setting	Baud Rate (BPS)
0	2400
1	4800
2	9600
3	19,200

n155 : Modbus Parity Selection

Factory setting: **2**

Range: 0 to 2

Selects the parity, as indicated by the following table:

Setting	Parity
0	Even
1	Odd
2	None

NOTE: To change the values set in **n153** thru **n155** and enable the new settings, it is necessary to turn OFF power to the Drive, then turn it ON again.

n151 : Modbus Time Out Detection

Factory setting: 1

Range: 0 to 4

If time between Modbus messages exceeds 2.0 seconds, the drive will respond according to the table below. A setting of " 4 " disables this fault condition.

If communications error exists, drive will respond according to the following table:

Setting	Description
0	Coast to Stop (fault)
1	Ramp to Stop using n020 (fault)
2	Ramp to Stop using n022 (fault)
3	Continue Operation (Alarm)
4	Disabled

D. Loop Test

The Drive has the ability to perform a serial communications self-check, in the form of a loop test. Use the following steps to perform a loop test.

1. With power applied to the Drive set parameter **n056 = 35**.
2. Remove power from the Drive and wait for the charge light to go off.
3. Disconnect all wiring terminals R+, R-, S+, S- & S7.
4. Install the following wires:
 - connect S+ to R+
 - connect S- to R-
 - connect S7 to SC
5. Apply power to the Drive.

If the Drive displays a normal frequency reference, the loop test was successful.

If the Drive displays "CE" on the digital operator, the loop test failed and the serial communications hardware is not functioning correctly. Remove power and recheck all of the above connections. Re-apply power. If the Drive still displays "CE", the unit will need to be replaced.

6. Remove power from the Drive.
7. Disconnect the wires installed in step 4.
8. Re-apply power and program **n056** to its previous setting. NOTE: the factory setting of **n056 = 10**.

5.15 MISCELLANEOUS PROTECTIVE FUNCTIONS

n010 : Operator Connection Fault Detection Selection

Factory setting: **0**

Range: 0 or 1

Set this parameter to “1” only if the drive should shut down immediately if the Digital Operator is disconnected while the drive is running. When set to “0”, the fault will not occur until after the drive has been stopped.

5.16 MOMENTARY POWER LOSS RIDE-THRU

n081 : Momentary Power Loss Ride-thru Protection

- 0** = Disabled (Factory setting)
- 1** = Enabled – 2 sec. power loss ride-thru
- 2** = Enabled – indefinite power loss ride-thru, provided control power is maintained

The setting of this parameter either enables or disables the ride-thru feature of the Drive. If disabled, the unit will stop immediately whenever a power loss occurs. If enabled, the Drive will continue to operate during a momentary power loss of up to 80%, but if the loss exceeds the identified time period, the Drive will stop.

5.17 MULTI-FUNCTION ANALOG MONITOR OUTPUT (Term. AM & AC)

n065 : Monitor output Selection

Factory Setting: **0**

Range: 0 – 1

Analog output AM & AC can be used as a pulse train output (output frequency monitor only).

SETTING	DESCRIPTION
0	Analog monitor output
1	Pulse train output (output frequency monitor)

n066 : Multi-function Analog Output

Factory Setting: **1.00**

Range: 0 – 5

The monitor output provides a 0-10 Vdc signal proportional to either output frequency or output current between terminals AM & AC:

- 0** = 0-10 Vdc proportional to output frequency (10V = 100% of maximum frequency)
- 1** = 0-10 Vdc proportional to output current (10V = 100% of drive rated current)
- 2** = 0-10 Vdc proportional to DC Bus Voltage (10V = 400 Vdc [800 Vdc])
- 3** = 0-10 Vdc proportional to motor torque (10V = motor rated torque)
- 4** = 0-10 Vdc proportional to output power (10V = drive capacity (KW))
- 5** = 0-10 Vdc proportional to output voltage (10V = **n012** (Voltage max))
- 6** = 0-10 Vdc proportional to frequency reference

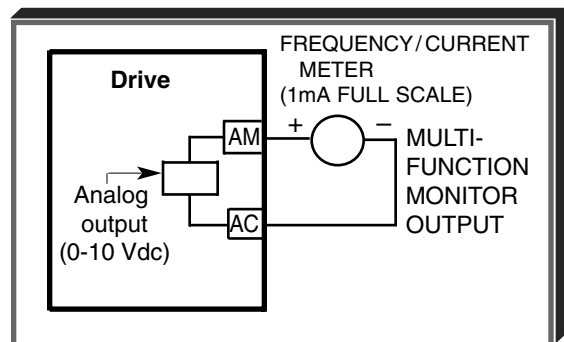

5.17 MULTI-FUNCTION ANALOG MONITOR OUTPUT (Term. AM & AC)

Continued

n067 : Analog Monitor Gain

Factory Setting: **1.00**

Range: 0.01 to 2.00

This constant is used to calibrate the meter connected to terminals AM & AC.

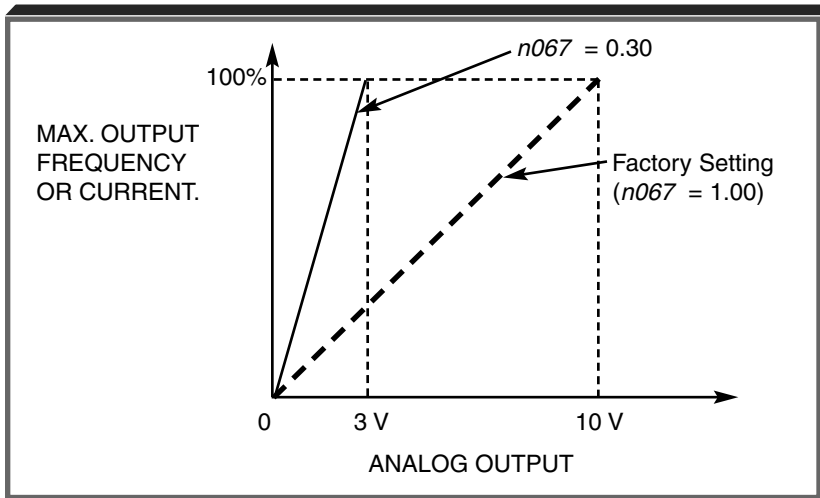

n150 : Pulse Monitor Output
Frequency Output/Reference

Factory Setting: **0**

Range: 0, 1, 6, 12, 24, 36, 40 - 45

SETTING	DESCRIPTION
0	1140Hz/ Max. frequency (n011)
1	1F: Output frequency x 1
6	6F: Output frequency x 6
12	12F: Output frequency x 12
24	24F: Output frequency x 24
36	36F: Output frequency x 36
40	1140Hz/Max. frequency (n011)
41	1F: Frequency reference x 1
42	6F: Frequency reference x 6
43	12F: Frequency reference x 12
44	24F: Frequency reference x 24
45	36F: Frequency reference x 36

At the factory setting of "0" a pulse train frequency of 1440 Hz will be output when output frequency is 100% .

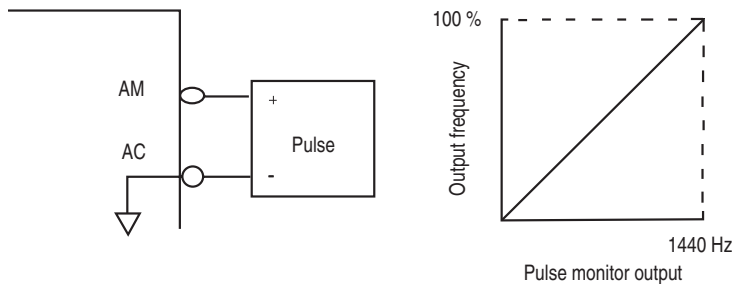

When connecting peripheral devices the following load limitations must be considered.
When using output as a sourcing output:

Max output voltage (V)	Load Impedance (K ohms)
+5V	1.5K ohms to 3.499K ohms
+8V	3.5K ohms to 9.99K ohms
+10V	10K ohms or more

When used as a sinking input:

External power supply (v)	+12VDC +/-5%
Sinking current (mA)	16mA or less

5.18 MULTI-FUNCTION INPUT TERMINALS (Term. S1-S7)

The multi-function input terminals can be activated in one of two ways:

Type of input	Description
NPN (Factory Setting)	A contact closure must be made between a multi-function terminal (S1 to S7) and SC in order to activate that input.
PNP	A DC voltage (+24v, 8mA max. current) must be present on a multi-function supply input terminal (S1 to S7) in order to activate that input. NOTE: The minus (-) side of the 24 VDC supply must be connected to SC.

The multi-function inputs are configured using rotary switch SW1, which is located above the upper row of control circuit terminals and can be set with a small screwdriver.

NOTE: All power must be removed from the Drive before SW1 can be set.

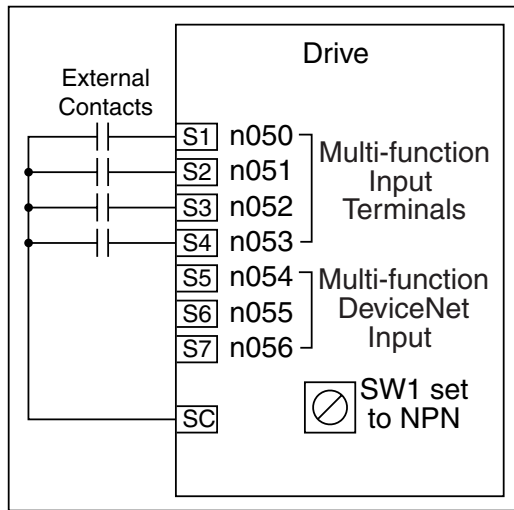

External wiring for NPN inputs

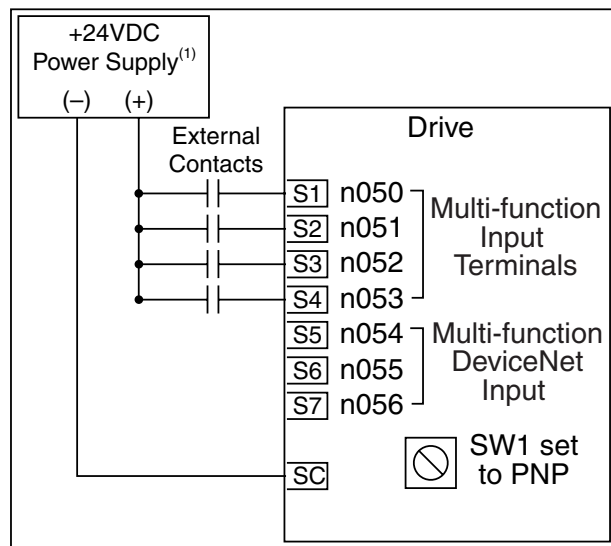

External wiring for PNP inputs

(1) Customer supplied component

n050 : Terminal S1 Function
n051 : Terminal S2 Function
n052 : Terminal S3 Function
n053 : Terminal S4 Function
n054 : Terminal S5 Function
n055 : Terminal S6 Function
n056 : Terminal S7 Function

Factory settings:	2-Wire control	3-Wire control
n050	1	1
n051	2	2
n052	3	0
n053	5	5
n054	6	6
n055	7	7
n056	10	10

These seven parameters select the input signal function for terminals S1 thru S7, and can be independently set.

Parameter settings are checked whenever the enter key is pressed. A parameter set failure (**Err**) will occur if any of the following conditions are detected:

- Two parameters contain the same value (**n050** thru **n056**).
- Both the Accel/Decel Hold (data **16**) and the Up/Down (data **34**) functions have been selected.

Table 5-2 lists the possible data setting values and their descriptions for these parameters.

Table 5-2. n050 thru n056 Data Settings

DATA	FUNCTION	DESCRIPTION*
0	FWD/REV selection (for 3-wire control)	MUST BE SET ONLY IN n052 . Redefines terminals: S1 = Run; S2 = Stop; S3 = FWD/REV select
1	Forward Run/Stop command (for 2-wire control)	Closed = Run Forward (2-wire control) Open = Stop
2	Reverse Run/Stop command (for 2-wire control)	Closed = Run Reverse (2-wire control) Open = Stop
3	External fault (N.O. contact input)	Drive trips; Digital Operator displays " EFX ", where X is 1-7, corresponding to the terminal, S2-S6, which is receiving the fault input signal
4	External fault (N.C. contact input)	
5	Fault Reset	
6	Multi-step frequency ref. select A	
7	Multi-step frequency ref. select B	See paragraph 5.11B
8	Multi-step frequency ref. select C	
9	Multi-step frequency ref. select D	
10	Jog selection	
11	Accel/decel time selection 1	Open = Accel/decel by n019 / n020 Closed = Accel/decel by n021 / n022 See paragraph 5.2
12	External base block (N.O. contact input)	Closed = Shuts off the Drive output (frequency command is held) See paragraphs 5.18B, 5.18C
13	External base block (N.C. contact input)	
14	Speed Search 1	Closed * = Speed Search operation from maximum frequency See paragraph 5.18D
15	Speed Search 2	Closed * = Speed Search operation from set frequency See paragraph 5.18D
16	Accel/Decel Hold	See paragraph 5.18F
17	Remote/Local selection	See paragraph 5.18A
18	Drive operation & reference/serial communication selection	Open = Operates according to setting of n003 & n004 Closed = Operates from serial communication See paragraph 5.13
19	Fast Stop - Fault (Normally Open Contact)	Open = No effect Closed = If n005 = 0, ramp to stop using n022 If n005 = 1, coast to stop
20	Fast Stop - Alarm (Normally Open Contact)	Open = No effect Closed = If n005 = 0, ramp to stop using n022 If n005 = 1, coast to stop
21	Fast Stop - Fault (Normally Closed Contact)	Open = If n005 = 0, ramp to stop using n022 If n005 = 1, coast to stop Closed = No effect
22	Fast Stop - Alarm (Normally Closed Contact)	Open = If n005 = 0, ramp to stop using n022 If n005 = 1, coast to stop Closed = No effect
26	Overheat Pre-Alarm OH3	Open = No effect Closed = OH3 alarm
27	Accel/Decel Time Select 2	See paragraph 5.2
34	Up/Down function	See paragraph 5.18E (can only be set in n056)
35	Loop Test (Serial Communications)	See paragraph 5.14D Can only be set in n056

* All contact closures must be maintained, except for speed search, which may be momentary (see paragraph 5.18D).

A. Data 17 : Remote/Local

The use of a Remote/Local command input allows switching between the Digital Operator control and the external terminal input signals or serial communications, without the need to re-program **n003** or **n004**. If the status of the Remote/Local command input is changed while the drive is running, the Remote/Local operation selection is not completed until the next time the Drive is stopped.

Closed = Controlled locally (Digital Operator)

NOTE: Parameter **n008** determines if the frequency reference will come from the digital operator potentiometer or parameter **n024**.

Open = Controlled remotely (external terminal inputs, for Start/Stop and frequency reference, or serial communications).

NOTE: When a multi-function input terminal is programmed for Local/Remote, the LO/RE LED will only display local or remote status. Local/Remote cannot be adjusted from the digital operator.

B. Data 12 : External Base Block by N.O. Contact

- When either the Forward Run command or Reverse Run command is present, and the external Base Block command is applied (i.e. contact closed), coast stop is accomplished (after a 20 msec delay), while the frequency command is maintained. When the Base Block command is removed, the drive will recover in a manner similar to that of Speed Search operation.
- When both the Forward Run command and Reverse Run command are open, and the external Base Block command is applied (i.e. contact closed), coast stop is accomplished and after a 20 msec delay the frequency command is changed to 0Hz. When the Base Block command is removed, the drive will remain in stopped condition until Forward Run command or Reverse Run command is again applied.
- When external Base Block command is active, a blinking “**bb**” will be displayed on the Digital Operator.

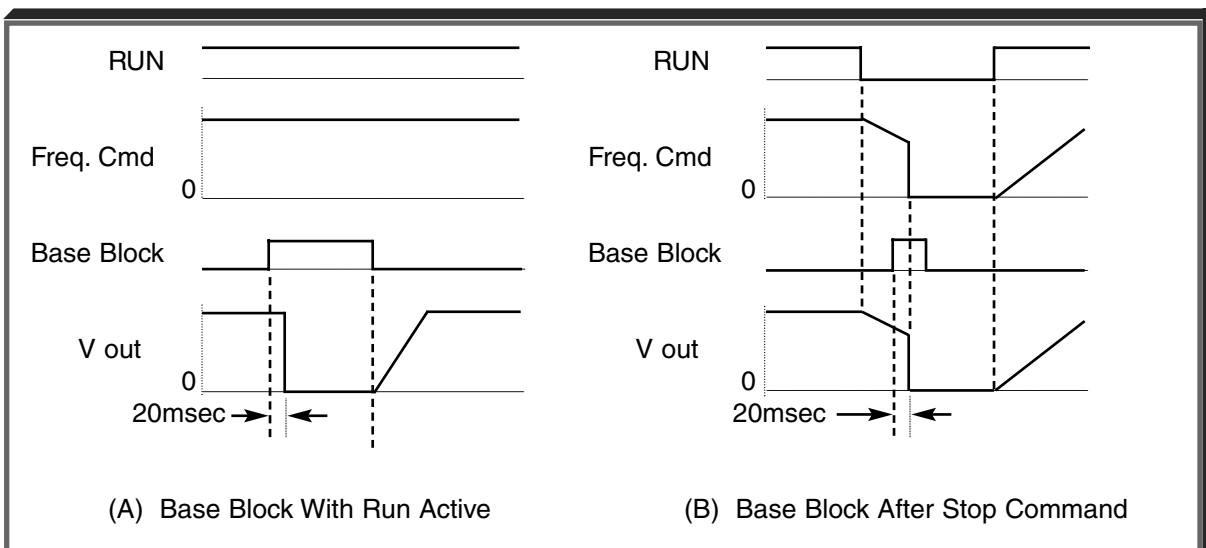
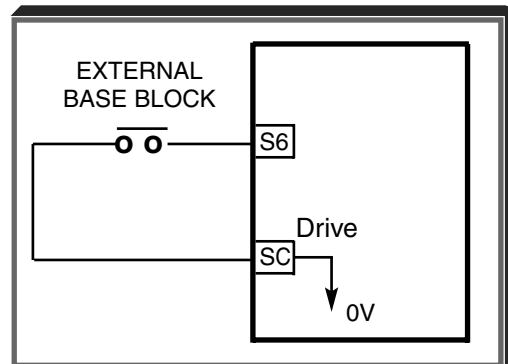

C. Data 13 : External Base Block by N.C. Contact

Base block operation is the same as described above, except that the Base Block contact must be *open* to be recognized.

**D. Data 14 : Speed Search From Max Frequency
Data 15 : Speed Search From Set Frequency**

A multi-function input terminal is utilized to activate speed search. When the external speed search command is closed, the base is blocked for the min. base block time, then the speed search is made. The operation depends on the set value.

IMPORTANT

Set values **14** and **15** CANNOT be selected in combination.

- When **14** is set, the speed search begins with the maximum frequency.
- When **15** is set, the speed search begins with the frequency command command that has been set after the search command was received.

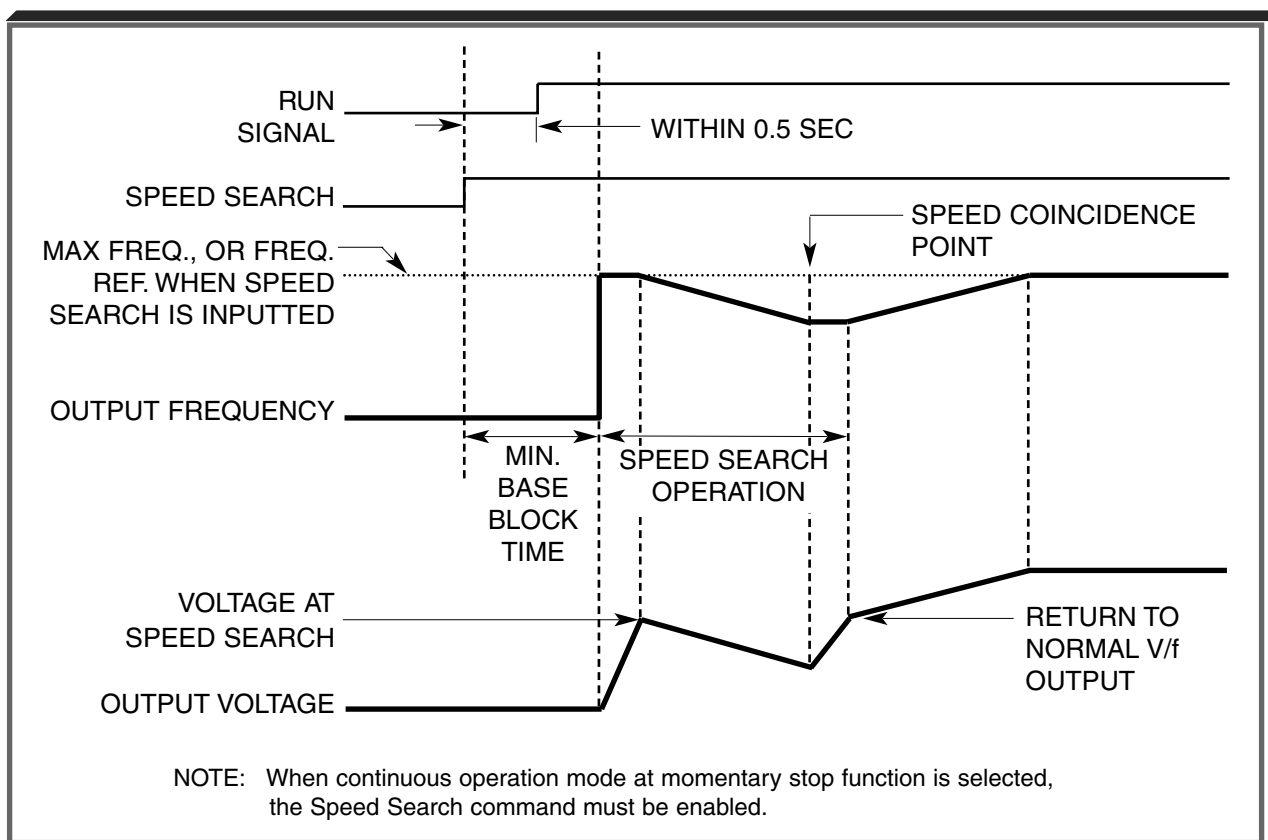

Speed Search Operation Timing

E. n101 : Speed Search Deceleration Time

Factory setting: 2.0
Range: 0.0 to 10.0 seconds

Deceleration time during a speed search

n102 : Speed Search Operation Level

Factory setting: 150
Range: 0 to 200%

Speed search starts if the drive's output current \geq speed search operation level.

F. Data 34 : Up/Down Function

Programming data " 34 " for **n056** (multi-function input terminal) allows the S6 / S7 inputs to be used for Up/Down frequency setting.

NOTES:

1. Parameter **n055** will not be valid when **n056** is set to " 34 ".
2. Jog has priority over Up/Down.
3. Up/Down has priority over Multi-step Frequency inputs.
4. Upper limit speed is set by the formula:

$$n011 (F_{max}) \times \frac{n033 (\text{Freq. Ref. Upper Limit})}{100}$$
5. Lower limit speed is from **n034** , Frequency Reference Lower Limit.
6. See section 5.10 for information on the Up/Down hold memory.

EXAMPLE:

n056 Data 34: Up/Down function

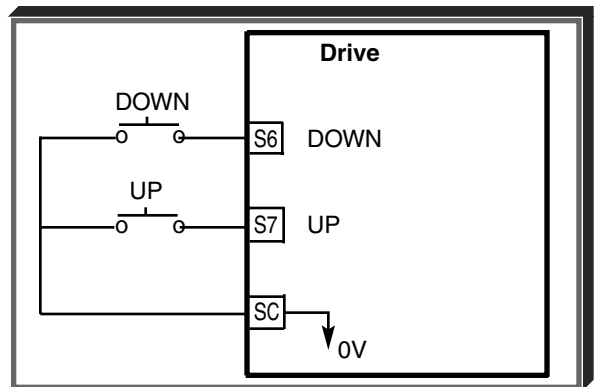

INPUT SIGNAL		FUNCTION
Term. S6	Term. S7	
DOWN	UP	
Open	Open	HOLD
Open	Closed	DOWN (Frequency command approaches minimum output frequency or frequency command lower limit, whichever is larger)
Closed	Open	UP (Frequency command approaches frequency command upper limit)
Closed	Closed	HOLD

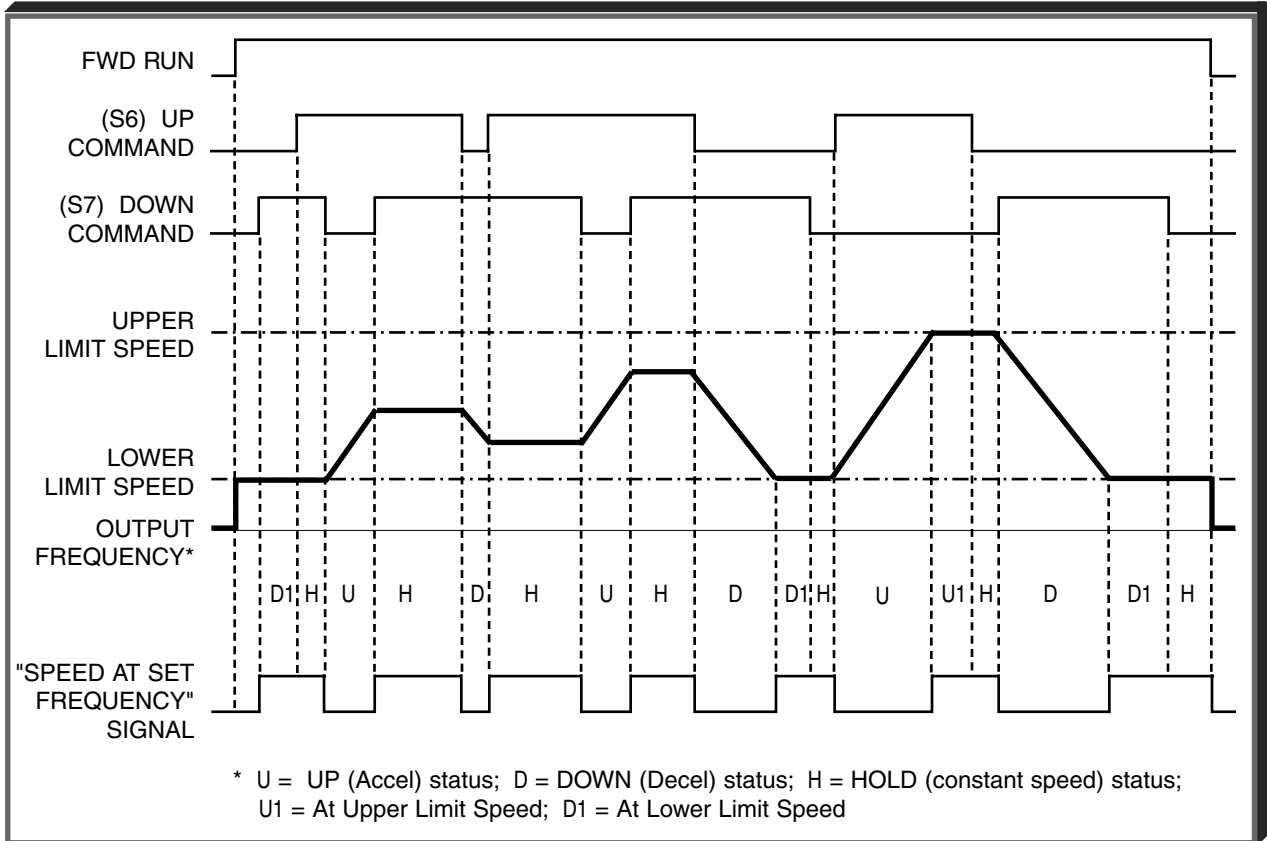

Up/Down Frequency Setting Timing

G. Data 16 : Accel/Decel Hold

By programming data " 16 " into one of the multifunction input parameters (*n050* thru *n057*), one of the multi-function input terminals (S1 thru S7) becomes a HOLD command input. As long as the HOLD command is present, accel and decel are in a prohibit state, and the output speed is held at the level it was at the time the HOLD command was input. When the HOLD command is removed while the system is still in Run condition, accel or decel will again become active to allow output to reach set speed. If Stop is initiated while the HOLD command is present, the prohibit state is cancelled and the system enters stop operation.

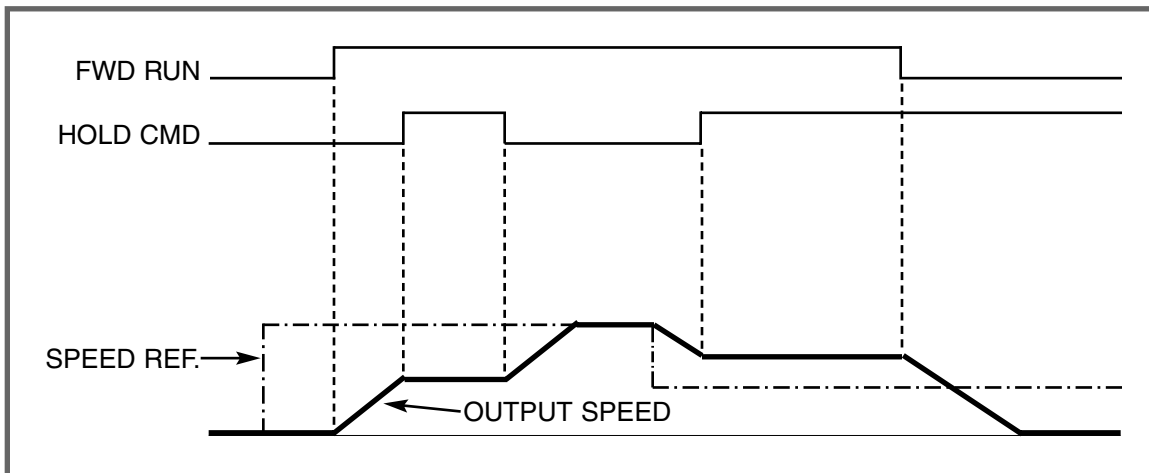

HOLD Function Timing

5.19 MULTI-FUNCTION OUTPUT TERMINALS (Term. MA, MB, MC, P1, P2, PC)

- n057** : Contact Output (external terminals MA, MB, & MC)
- n058** : Open Collector Output (external terminals P1 & PC)
- n059** : Open Collector Output (external terminals P2 & PC)

A contact, or two different open collector outputs, can be programmed to change states during any of the conditions indicated in Table 5-3.

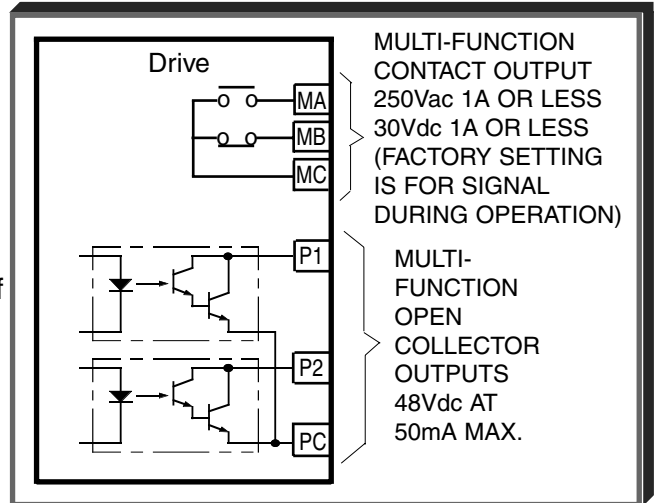

IMPORTANT

If an open collector output is applied to a DC relay, the relay **MUST** be diode protected, as shown in the recommended configuration below.

Recommended Configuration for DC Relays

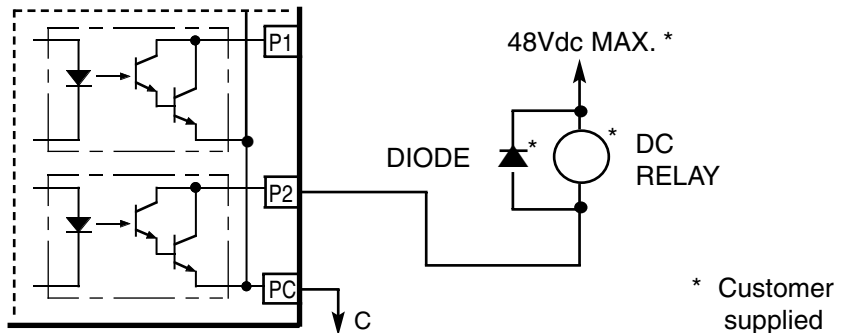

5.19 MULTI-FUNCTION OUTPUT TERMINALS (Term, MA, MB & MC; P1, P2 & PC)

Table 5-3. Multi-function Output Terminals

0	Fault	Closed = Drive fault has occurred (except CPF00, CPF01)
1	During operation	Closed = Drive is operating
2	Speed at set frequency	Closed = Frequency Reference = output frequency See paragraph 5.19A
3	Zero Speed	Closed = Drive is at zero Hz.
4	Frequency detection - low	Closed = Output frequency $\leq n095$. See paragraph 5.19B
5	Frequency detection - high	Closed = Output frequency $\geq n095$. See paragraph 5.19C
6	Overtorque detection (N.O. contact)	Closed = Overtorque detected See paragraph 5.20
7	Overtorque detection (N.C. contact)	Open = Overtorque detected See paragraph 5.20
8	Under torque detection (NO)	Closed if under torque is detected
9	Under torque detection (NC)	Open if under torque is detected
10	Alarm (minor fault)	Closed = Alarm condition is present
11	During coast to stop	Closed = Drive output base block is active; motor is coasting
12	Local/Remote	Open = Frequency and Run Command by ext. input; Closed = Frequency and Run Command by Digital Operator
13	Operation ready	Closed = Drive is ready for operation (not faulted)
14	Auto-restart	Closed = During auto-restart operation
15	During Undervoltage	Closed = Drive has an undervoltage fault or warning.
16	During Reverse run	Closed = Drive operation in reverse
17	During Speed Search	Closed = Drive performing a speed search
18	Serial communication	Closed = Command from serial communication
20	Frequency reference is missing	Closed if frequency reference is missing
21	Inverter overheating pre-alarm OH3	Closed if drive overheat pre-alarm is input at a Multi-function Input. Digital operator display is "OH3" (blinking)

5.19 MULTI-FUNCTION OUTPUT TERMINALS

Continued

n095 : Speed Coincidence Frequency / Frequency
Detection Level

Factory setting: **0.0** Hz

Range: 0.00 to 400.0 Hz

Speed coincidence is used to control an output contact at terminals MA or MB (with respect to terminal MC), or terminals P1, P2 & PC, when selected by **n057**, **n058** and **n059**.

n057, **n058** or **n059**

Data **2**, **4** or **5**

The output contact will close, dependent upon the data programmed into **n057**, **n058** or **n059**. See the appropriate figure below for operation.

A. Speed at Set Frequency (setting: **n057**, **n058** or **n059** = " 2 ")

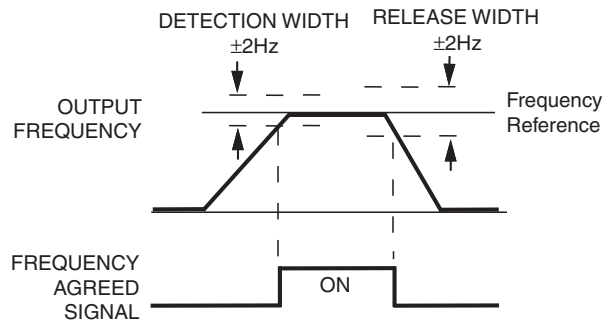

B. Frequency Detection – Low (setting: **n057**, **n058** or **n059** = " 4 ")

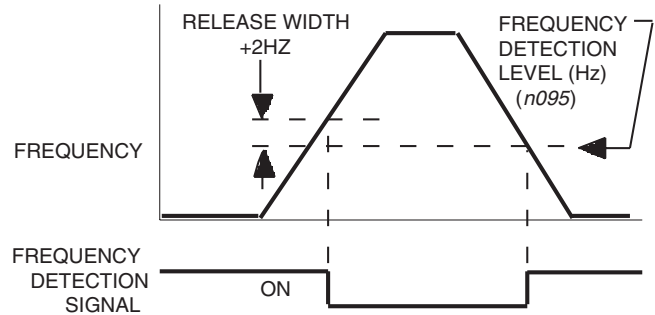

C. Frequency Detection – High (setting: **n057**, **n058** or **n059** = " 5 ")

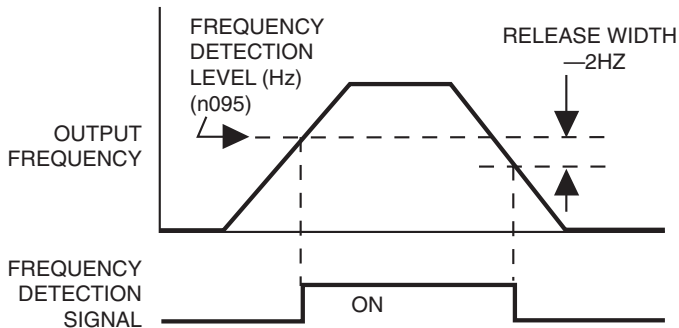

5.20 OVERTORQUE DETECTION

Overtorque detection is used to compare Drive rated output current/torque with the overtorque detection level. When the output current is equal to or greater than the defined level, an overtorque condition exists. This will be indicated as an **oL3** fault on the Digital Operator. This feature can be selected to operate over a wide range of conditions.

A. **n096** : Overtorque Detection

Factory setting: **0**

This constant determines whether the overtorque detection function of the Drive is enabled, under what conditions it will detect for overtorque, and what operation it will perform after detecting an overtorque.

Setting	Overtorque Disabled	Operation After Detection	Detection Condition
0	Disabled	—	—
1	Overtorque	Continues	Only at set frequency
2	Overtorque	Coast to stop	Only at set frequency
3	Overtorque	Continues	At all times except during stopping or DC injection braking
4	Overtorque	Coast to stop	At all times except during stopping or DC injection braking

- For overtorque detection during accel or decel, set to " 3 " or " 4 ".
- For continuous operation after overtorque detection, set to " 1 " or " 3 ". During detection, the Digital Operator displays and " **oL3** " alarm (blinking).
- To stop the drive at an overtorque detection fault, set to " 2 " or " 4 ". At detection, the Digital Operator displays an " **oL3** " fault.
- To output an overtorque detection signal, set output terminal function selection (**n057**, **n058** or **n059**) to " 6 " or " 7 ".

B. **n098** : Overtorque Detection Level

Factory setting: **160** %

Range: 30 to 200 %

This is the reference point for determining that an overtorque condition exists. Set as a percent of Drive rated current or as a percent of motor rated torque.

C. **n097** : Overtorque Detection Selection During Open Loop Vector Control

Factory setting: **0**

Setting	Description
0	Detected by motor output torque (as a percentage of motor rated torque)
1	Detected by drive output current (as a percentage of drive rated current)

This parameter is only effective when the drive is in the Open Loop Vector control method.

D. **n099** : Overtorque / Undertorque Detection Time

Factory setting: **0.1** sec.

Range: 0.0 to 10.0 seconds

Determines how long an overtorque condition must exist before another event will occur, e.g. coast to stop, multi-function output change of state, or **oL3** warning or fault display.

5.20 OVERTORQUE DETECTION

Continued

- E. **n057** : Multi-function Output 1
(terminals MA, MB & MC)
n058 : Multi-function Output 2
(terminals P1 & PC)
n059 : Multi-function Output 3
(terminals P2 & PC)

Data **6** or **7** : Overtorque
Detection

A Form-C contact, or an open collector output, can be programmed to change states during an overtorque detection condition.

EXAMPLE OF OVERTORQUE DETECTION

- n096** setting: **2** — Overtorque enabled, only at set frequency, coast to stop
n057 setting: **6** — Output contact programmed for overtorque detection
n096 setting: **110 %** — Level at which overtorque is sensed
n099 setting: **1.0 s** — Time delay before overtorque event occurs

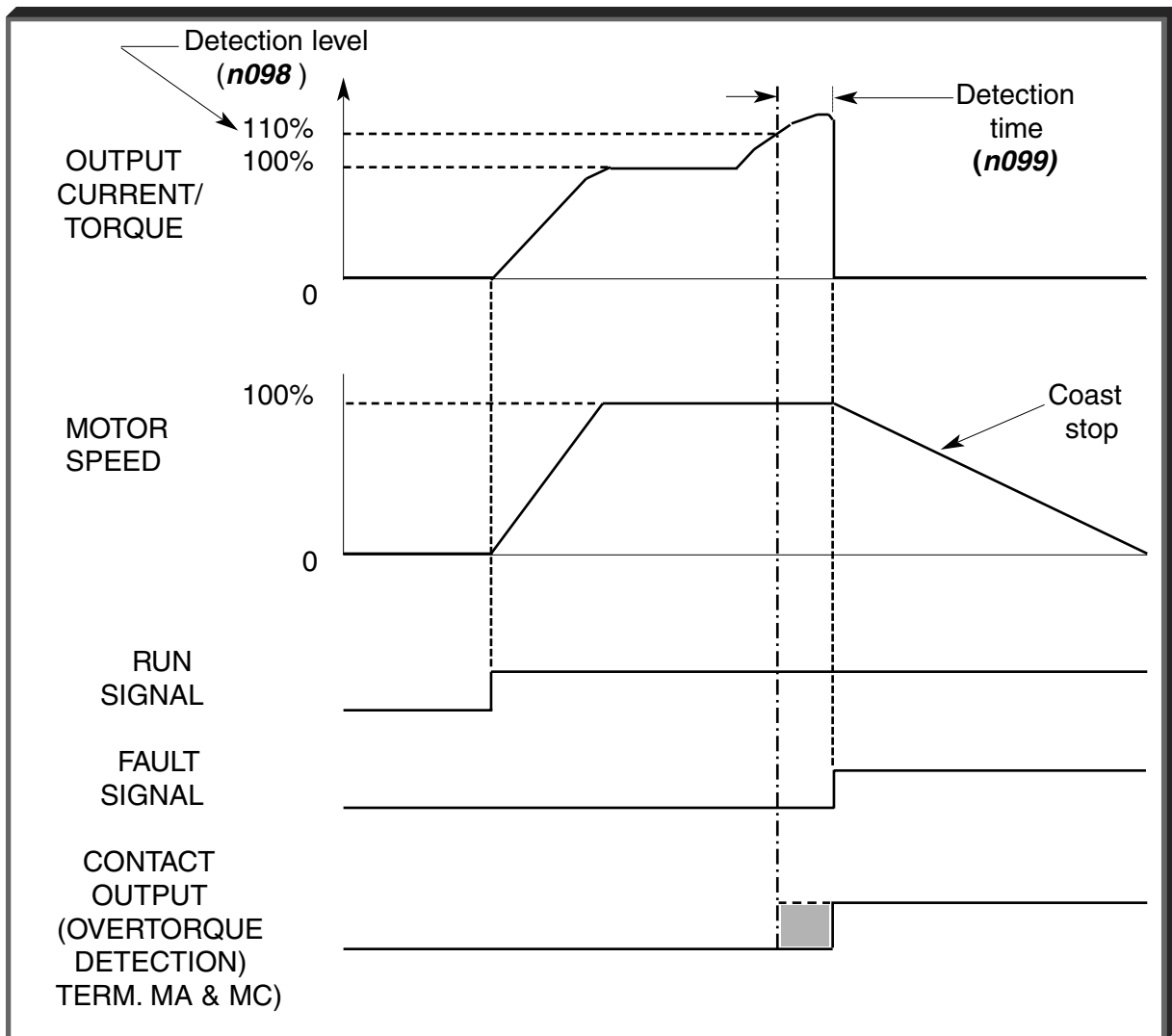

Overtorque Detection Timing Diagram

5.21 RESET CODES: 2-WIRE, 3-WIRE INITIALIZATION

n001 : Parameter Selection / Initialization

Factory setting: **1**

Range: 0 to 9

The following table shows which parameters can be programmed (displayed & changed) or only displayed when *n001* is selected.

Setting	Function
0	<i>n001</i> can be read and set; <i>n002</i> - <i>n179</i> read only
1	<i>n001</i> - <i>n039</i> can be read and set
2	<i>n001</i> - <i>n067</i> can be read and set
3	<i>n001</i> - <i>n113</i> can be read and set
4	<i>n001</i> - <i>n179</i> can be read and set
5	<i>n001</i> - <i>n179</i> can be read and set – Run Command accepted during Program Mode
6	Clear Fault Record Only
7	Not Used
10	Initialization: 2-Wire control
11	Initialization: 3-Wire control

CAUTION

Entering a “5” into *n001* will allow a RUN command to be accepted even if the drive is in Program mode (PRGM function LED on) or the LO/RE function LED is on. This condition may cause the motor to run; equipment damage or personal injury may result.

WARNING

By entering a “10” or an “11” into *n001*, all parameters in the Drive will return to their factory settings.

Parameter	Terminal	Factory Configuration for	
		2-Wire Control	3-Wire Control
<i>n050</i>	S1	1 = Forward Run	1 = Start
<i>n051</i>	S2	2 = Reverse Run	2 = Stop
<i>n052</i>	S3	3 = External Fault (N.O.)	0 = Fwd/Rev Command
<i>n053</i>	S4	5 = Fault Reset	5 = Fault Reset
<i>n054</i>	S5	6 = Multi Step Ref. Cmd. A	6 = Multi Step Ref. Cmd. A
<i>n055</i>	S6	7 = Multi Step Ref. Cmd. B	7 = Multi Step Ref. Cmd. B
<i>n056</i>	S7	10 = JOG Selection	10 = JOG Selection

CAUTION

Know your application before using either Initialization function of *n001* .

This parameter must be set to " 0 " to " 5 " for operation.

" 10 " = Factory 2-Wire Control Initialization (Maintained RUN Contact)

" 11 " = Factory 3-Wire Control Initialization (Momentary START/STOP Contact)

Entering either Initialization code resets all parameters to factory settings, and automatically returns *n001* setting to " 1 ". If the Drive is connected for 3-Wire control and this parameter is set to " 10 " (2-Wire Control Initialization), the motor may run in reverse direction WITHOUT A RUN COMMAND APPLIED. Equipment damage or personal injury may result.

IMPORTANT

After " 10 " or " 11 " has been entered in *n001* , the Motor Rated Current (*n036*) MUST BE REPROGRAMMED to the correct setting for the application.

5.22 SLIP COMPENSATION

n111 : Slip Compensation Gain

Factory setting: See Table A3-1

Range: 0.0 to 2.5

Slip compensation is used to increase motor speed to account for slip; the drive accomplishes this by automatically boosting output frequency, with a corresponding boost in output voltage.

The slip compensation gain (**n111**) determines how much compensation frequency is added. If using the Drive in Open Loop Vector, typically no adjustment is necessary. The equation below illustrates how the compensation frequency is generated.

NOTE: A slip compensation gain setting of 0.0 disables slip compensation.

$$\text{Compensation Frequency} = \frac{\text{Output Current} - \frac{(n110 * n036)}{100}}{n036 - \frac{(n110 * n036)}{100}} * n106 * n111$$

Slip Compensation Equation

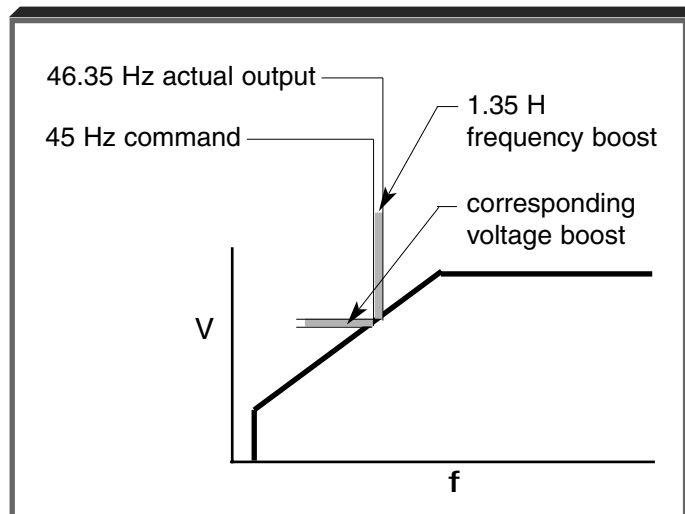

n110 : Motor No-Load Current

Factory setting: See Table A3-1

Range: 0 to 99%

Motor no-load current (**n110**) is set as a percentage of motor full-load current (**n036**). It is used as shown in the slip compensation equation.

n112 : Slip Compensation Primary Delay
Time Constant

Factory setting: **2.0** sec.

Range: 0.0 to 25.5 sec.

Parameter **n112** can be increased to improve stability or decreased to improve response to load changes.

n113 : Slip Compensation Selection
During Regen

Factory setting: **0**

Range: 0 or 1.

Parameter **n113** determines whether the slip compensation gain will be enabled or disabled during regeneration.

Setting	Description
0	Disabled - No slip compensation will be added when regenerating
1	Enabled - Slip compensation will be added when regenerating

5.23 STALL PREVENTION

A. *n092* : Stall Prevention During Deceleration

Factory setting: **0**

Setting	Function
0	Stall prevention during deceleration enabled
1	Stall prevention during deceleration disabled

Stall prevention during deceleration automatically adjusts the deceleration rate while monitoring the DC bus voltage to prevent overvoltage during deceleration.

When the motor load is large or decel time is short, actual decel time may be longer than the set value because of stall prevention.

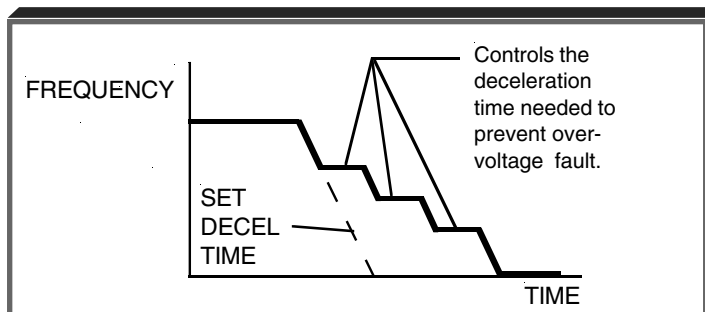

B. *n093* : Stall Prevention Level During Acceleration

Factory setting: See Table A3-1

Range: 30 - 200 %

This parameter determines the actual Drive output current level during an acceleration condition. Set in percent of Drive rated output current.

A setting of " 200 " disables stall prevention during acceleration. During acceleration, if the output current exceeds the value in *n093* , acceleration stops and frequency is maintained. When the output current goes below the value set in *n093* , acceleration resumes.

In the constant horsepower region [actual output frequency \geq max. voltage frequency (*n013*)], the stall prevention level during acceleration is changed by the following formula:

$$\text{Stall prevention level during accel (constant horsepower)} = \text{Stall prevention level during accel} \times \frac{\text{Max. voltage frequency}}{\text{Actual output frequency}}$$

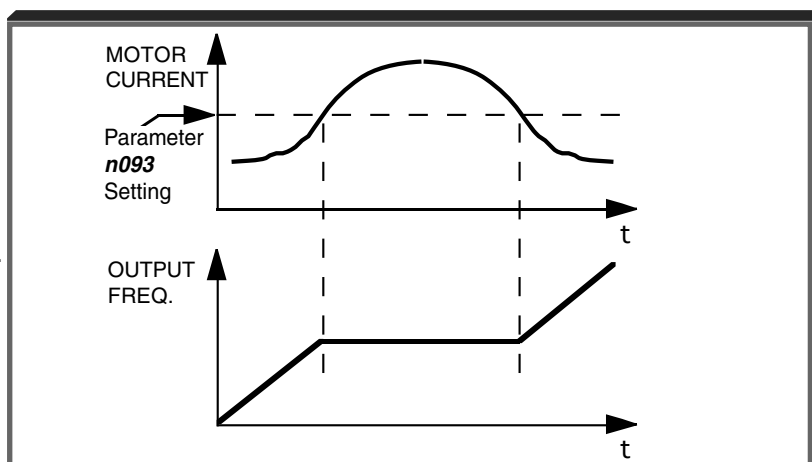

C. *n094* : Stall Prevention Level At Set Speed

Factory setting: **160%**

Range: 30 - 200 %

This parameter determines the actual Drive output current level while operating at set speed (frequency). Set in percent of Drive rated output current (see Appendix 2).

A setting of " 200 " disables stall prevention at set speed. During running at set speed, if the output current exceeds the value set in *n094* , the drive will begin to decelerate. When the output current goes below the value set in *n094* , acceleration begins, up to the set frequency.

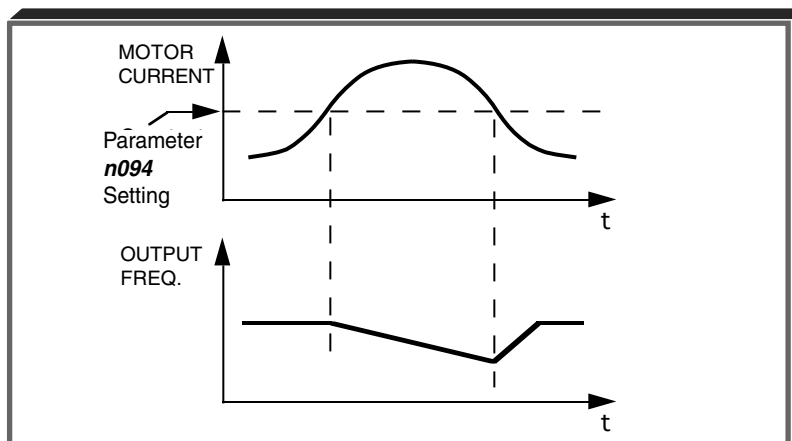

5.23 STALL PREVENTION

Continued

D. n115 : Stall Prevention Above Base Speed During RunningFactory setting: **0**

Range: 0 or 1

Setting	Function
0	Disabled (level is based on setting of n094)
1	Enabled (level at Fmax, n011 , is n094 x 0.4)

E. n116 : Stall Prevention During Run, Accel/Decel Time SelectFactory setting: **0**

Range: 0 or 1

Setting	Function
0	Follows accel/decel #1 (n019, n020) or accel/decel #2 (n021, n022) Note: Multi-Function input selectable
1	Follows accel/decel #2 (n021, n022) always

5.24 STOPPING METHOD

n005 : Stopping Method

Factory setting: **0**

Range: 0 to 1

Selects the stopping method suitable for the application.

Setting	Description
0	Deceleration (ramp) to stop
1	Coast to stop

A. Data **0** : Deceleration to Stop

Upon removal of the FWD (REV) Run command, the motor decelerates at the deceleration rate determined by the time set in Decel Time 1 (**n020**), and DC injection braking is applied immediately before stop. If the decel time is too short or the load inertia is too large, an over-voltage (OV) fault may occur on a stop command — the decel time must be increased.

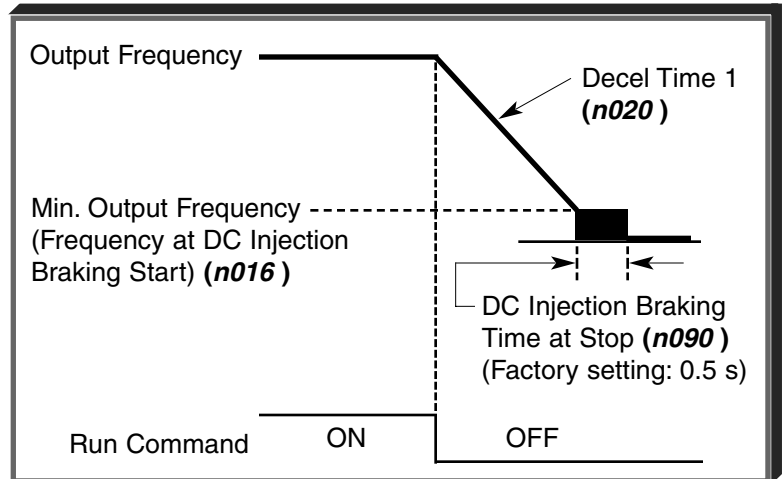

B. Data **1** : Coast to Stop

Upon removal of the FWD (REV) Run command, the motor coasts to rest.

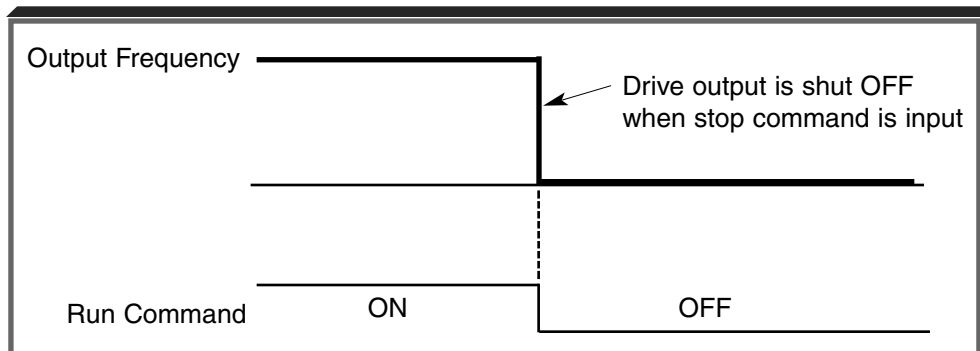

5.25 THERMAL OVERLOAD PROTECTION

n036 : Motor Rated Current

Factory setting: See Table A3-1

Range: see description

This parameter should be set, in increments of 0.1 A, to the rated current (FLA) value shown on the motor nameplate; this value **MUST BE** between 10% and 150% of the *drive rated current*. If the motor FLA does not fall within this range, a different Model No. drive must be used.

NOTE: Setting **n036** to " 0.0 " disables the motor overload protection function, regardless of the setting of **n037** or **n038**.

n037 : Electronic Thermal Motor Protection

Factory setting: **0**

Range: 0 to 2

Setting	Electronic Thermal Characteristics
0	Short term rating
1	Standard rating
2	Electronic thermal overload protection disabled

n038 : Electronic Thermal Overload Protection Time Constant

Factory setting: **8**

Range: 1 to 60 min.

This parameter sets the electronic thermal overload relay protection time when when 150% of overload is applied after the motor is operated continuously at rated current.

The Drive protects against motor overload with a UL-recognized, built-in electronic thermal overload relay.

The electronic thermal overload function monitors motor temperature, based on drive output current and time, to protect the motor from overheating. When the electronic thermal overload trips, an "oL1" error occurs, shutting OFF the drive output and preventing excessive overheating of the motor.

When operating with one drive connected to only one motor, an external thermal relay is not needed. When operating several motors with one drive, install a thermal overload relay on each motor.

	Cooling Effect	Current Characteristics	Electronic Thermal Overload
Short Term Rating	Effective when operated at 60Hz from a commercial power supply	<p>Base Frequency 60Hz (V/f for 60Hz, 230V Input Voltage)</p>	"oL1" error (motor overload protection) occurs when continuously operated at less than 60Hz at 100% load.
Standard Rating	Effective when operated at low speed (approx. 6Hz)	<p>Base Frequency 60Hz (V/f for 60Hz, 230V Input Voltage)</p>	Electronic thermal overload protection not activated even when continuously operated at less than 60Hz at 100% load.

5.26 TORQUE COMPENSATION

n103 : Torque Compensation Gain (KT)

Factory setting: **1.0**

Range: 0.0 to 2.5

Torque Compensation Gain (**n103**) adjusts how much the output voltage is boosted when motor load increases. It is used to compensate for resistive losses in the motor and the wiring between the drive and the motor.

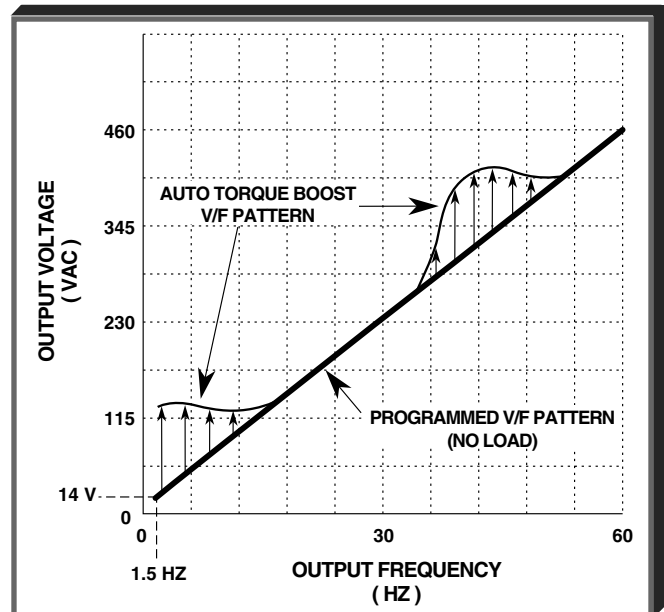

Example of Torque Compensation Operation

n104 : Torque Compensation Time Constant

Factory setting: See Table A3-2

Range: 0.0 to 2.5 (sec)

This parameter adjusts a time delay for the torque compensation gain. Increase to add torque stability, decrease to improve torque response.

n105 : Torque Compensation Iron Loss

Factory setting: See Table A3-1

Range: 0.0 to 6550 W

This parameter should be adjusted only when motor capacity and drive capacity are different.

n109 : Torque Compensation Limit

Factory setting: 150%

Range: 0 - 250%

This parameter sets the upper voltage limit used by torque compensation.

Except for the most demanding of high starting torque applications, the factory settings of these parameters will be adequate. The factory settings are set up to match the performance of typical AC motors.

5.27 V/f PATTERN

The V/f pattern can be tailored to suit your specific application and load characteristics by adjusting parameters **n011** to **n017** (see the V/f characteristics figure on the following page).

Table 5-4. Recommended V/f Patterns

Max. Freq.	Starting Torque	Load Type ¹	n011 (Hz)	n012 (V) ³	n013 (Hz)	n014 (Hz)	n015 (V) ³	n016 (Hz)	n017 (V) ³
50	Normal	VT	50	230	50	25.0	40.2	1.3	9.2
50	High ²	VT	50	230	50	25.0	57.5	1.3	11.5
60	Normal	VT	60	230	60	30.0	40.2	1.5	9.2
60	High ²	VT	60	230	60	30.0	57.5	1.5	11.5
50	Normal	CT	50	230	50	3.0	17.2	1.5	11.5
50	Medium	CT	50	230	50	2.5	23.0	1.3	13.8
50	High ²	CT	50	230	50	2.5	28.7	1.3	16.1
60	Normal	CT	60	230	60	3.0	17.2	1.5	11.5
60	Medium	CT	60	230	60	3.0	20.7	1.5	13.8
60	High ²	CT	60	230	60	3.0	28.7	1.5	23.0
72	Normal	CT	72	230	60	3.0	17.2	1.5	11.5
90	Normal	CT	90	230	60	3.0	17.2	1.5	11.5
120	Normal	CT	120	230	60	3.0	17.2	1.5	11.5
180	Normal	CT	180	230	60	3.0	17.2	1.5	11.5

NOTES:

¹ VT = Variable Torque, typically used for blowers, centrifugal pumps, and fans.

CT = Constant Torque, most other applications. Consult the manufacturer for further assistance.

The following conditions must be considered when selecting a V/f pattern:

- Pattern matches the voltage-frequency characteristics of the motor.
- Maximum motor speed.

² V/f pattern for high starting torque should be selected for:

- Long wiring distance.
- Large voltage drop at start
- AC reactor connected to Drive input or output.
- Use of motor rated below Drive max. output.

³ Voltages shown are for 230V motors; for other motor voltages, multiply all voltage (V) values by (Vmtr/230). i.e., for a 460V motor, multiply by 460/230 = 2.

5.27 V/f PATTERN

Continued

- n011** : Frequency – Max. (Fmax)
- n012** : Voltage – Max. (Vmax)
- n013** : Frequency – Max. Voltage point (FA)
- n014** : Frequency – Midpoint (FB)
- n015** : Voltage – Midpoint (Vc)
- n016** : Frequency – Min. (Fmin)
- n017** : Voltage – Min. (Vmin)

These seven parameters define the V/f pattern. The illustration below shows how these constants relate to each other in establishing the custom V/f pattern.

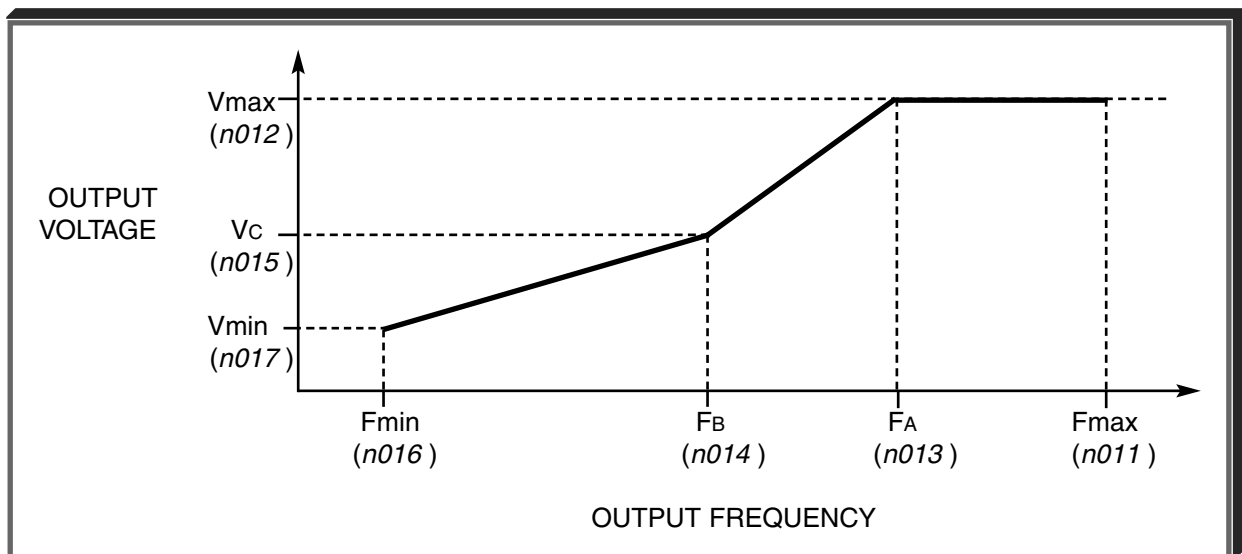

V/f Characteristics Set by n011 thru n017

NOTE: To establish a V/f pattern with a straight line from F_{min} to F_A , set $F_B = F_{min}$. The setting of V_c is then disregarded and does not affect the V/f pattern.

IMPORTANT

The V/f parameter settings are checked each time the **ENTER** key is pressed while programming the V/f parameters. A parameter set value failure (**Err**) will occur if any part of the following relationships among **n011** thru **n017** is not TRUE:

- (a) $F_{max} \geq F_A \geq F_B \geq F_{min}$
- (b) $V_{max} \geq V_c \geq V_{min}$

5.28 PID CONTROL

The Proportional, Integral and Derivative control function provides closed-loop control, or regulation, of a system process variable (pressure, temperature, etc.). This regulation is accomplished by comparing a feedback signal to a setpoint reference, which results in an error signal. The PID control algorithm then performs calculations, based upon the PID parameter settings (**n128 – n138**, **n163** and **n164**), on this error signal. The result of the PID algorithm is then used as the new frequency reference, or is added to the existing speed reference.

A. **n128** : PID Control Selection

Factory Setting: **0**

Range: 0 to 8

Setting	Description
0	PID Disabled
1	PID Enabled (D = Feed forward)
2	PID Enabled (D = Feedback)
3	PID Enabled, Reference + PID (D = Feed forward)
4	PID Enabled, Reference + PID (D = Feedback)
5	Inverse PID Enabled (D = Feed forward)
6	Inverse PID Enabled (D = Feedback)
7	Inverse PID Enabled, Reference + PID (D = Feed forward)
8	Inverse PID Enabled, Reference + PID (D = Feedback)

Using this parameter, PID control can be enabled, and the type of PID control can be selected.

B. **Setpoint Reference Selection**

n004 : Reference Selection

Factory Setting: **0**

Range: 0 to 6

n024 thru **n032**: Multi-step Frequency Presets

Factory Settings:

n032 = 6.0

all others = **0.0**

Range (each): 0.0 to 400.0 Hz

The frequency reference becomes the PID setpoint.

C. **Feedback Signal Selection**

n164: PID Feedback Selection

Factory setting: **0**

Range: 0 to 5

Setting	Description
0	Terminal FR (Voltage 0 – 10V)
1	Terminal FR (Current 4 – 20 mA)*
2	Terminal FR (Current 0 – 20 mA)*
3	Multi-Function Analog Input (0 – 10V)
4	Multi-Function Analog Input (Current 4 – 20mA)
5	Pulse Input

* Set SW2(2) to "I" (ON). SW2 consists of two separate slide switches and can be found just above the upper row of control circuit terminals. The switch towards the bottom (labeled "2") connects a 250Ω resistor from terminal FR to FC when set to the "I" (ON) position (to the right). NOTE: All power must be removed from the Drive before SW2 can be set. See Figure 1-1 for the location of SW2.

D. PID Settings**n130:** PID Proportional GainFactory setting: **1.00**

Range: 0.00 to 10.00

Proportional gain is the value by which the error signal is multiplied to generate a new PID controller output. A higher setting will result in a more responsive system. A lower setting will result in a more stable system.

n131: PID Integral TimeFactory setting: **1.00**

Range: 0.00 to 360.0 sec.

This parameter determines how fast the PID controller will seek to eliminate any steady-state error. The lower the setting, the faster the error will be eliminated. To eliminate the integral function entirely, set this parameter to 0.0 seconds. A lower setting will result in a more responsive system. A higher setting will result in a more stable system.

n134: Integral Value Limit ⁽¹⁾Factory setting: **100.00**

Range: 0.00 to 100.0%

This parameter will limit the effect that the integrator can have. It works whether the PID controller output is positive or negative. It can also be used to prevent integrator "wind-up".

n132: Derivative TimeFactory setting: **0.00**

Range: 0.00 to 10.0 sec

This parameter can be adjusted to increase system response to fast load or reference changes, and to reduce overshoot upon startup. To eliminate the differential function entirely, set this parameter to 0.00 seconds.

n163: PID Output Gain ⁽¹⁾Factory setting: **1.0**

Range: 0.00 to 25.0

This parameter is a multiplier in the output of the PID controller. Increasing this parameter will make the PID controller more responsive. Be careful not to increase this parameter too much or the drive / system will become unstable.

n133: PID Offset Adjustment ⁽¹⁾Factory setting: **0.0**

Range: -100.00 to 100.0%

This parameter will add a fixed percentage to the PID output. It can be used to tune out small system offsets. NOTE: This parameter is set as a percentage of maximum output frequency (n011).

n135: PID Output Lag Filter Time ⁽¹⁾Factory setting: **0.00**

Range: 0.00 to 10.00 sec.

This parameter adds a filter to the PID output to keep it from changing too quickly. The higher the setting, the slower the PID output will change.

All of these parameters are interactive, and will need to be adjusted until the control loop is properly tuned, i.e. stable with minimal steady-state error. A general procedure for tuning these parameters is as follows:

1. Adjust Proportional Gain until continuous oscillations in the Controlled Variable are at a minimum.
2. The addition of Integral Time will cause the steady-state error to approach zero. The time should be adjusted so that this minimal error is attained as fast as possible, without making the system oscillate.
3. If necessary, adjust derivative time to reduce overshoot during startup. The drive's accel and decel rate times can also be used for this purpose.

⁽¹⁾ These parameters are factory set for optimum results for most applications, and generally don't need to be changed.

E. Feedback Loss Detection**n136:** Feedback Loss Detection SelectionFactory setting: **0**

Range: 0 to 2

Setting	Description
0	Feedback loss detection is disabled
1	Feedback loss detection is enabled – <i>Fb</i> alarm only (drive continues running)
2	Feedback loss detection is enabled – <i>Fb</i> fault (drive coasts to stop)

n137: Feedback Loss Detection Level (PID)Factory setting: **0**

Range: 0 to 100 %

n138: Feedback Loss Detection Delay Time (PID)Factory setting: **1.0**

Range: 0.0 to 25.5

When feedback loss detection is enabled (**n136** = data "1" or "2"), the drive will detect if the feedback signal falls below the **n137** level for more than the **n138** delay time and respond according to the setting of **n136**.

F. Multi-Function Input Terminals**n050** thru **n056:** Multi-function Inputs
(Term. S1 thru S6)Data **23** : PID Control Off

By programming data "23" into one of the multi-function input parameters (**n050** thru **n056**), the corresponding multi-function input terminal (S1 thru S6) will disable the PID control. At the same time the PID setpoint will become the output frequency and the PID's integrator will reset to zero.

n050 thru **n056:** Multi-function Inputs
(Term. S1 thru S6)Data **24** : PID Integral Reset

By programming data "24" into one of the multi-function input parameters (**n050** thru **n056**), the corresponding multi-function input terminal (S1 thru S6) will immediately reset the integrator's value to zero.

n050 thru **n056:** Multi-function Inputs
(Term. S1 thru S6)Data **25** : PID Integral Hold

By programming data "25" into one of the multi-function input parameters (**n050** thru **n056**), the corresponding multi-function input terminal (S1 thru S6) will hold the integrator's output value. When the contact is closed (on the Multi-Function Input Terminal), whatever value the integrator is outputting will remain the same until the contact is opened.

PID Block Diagram

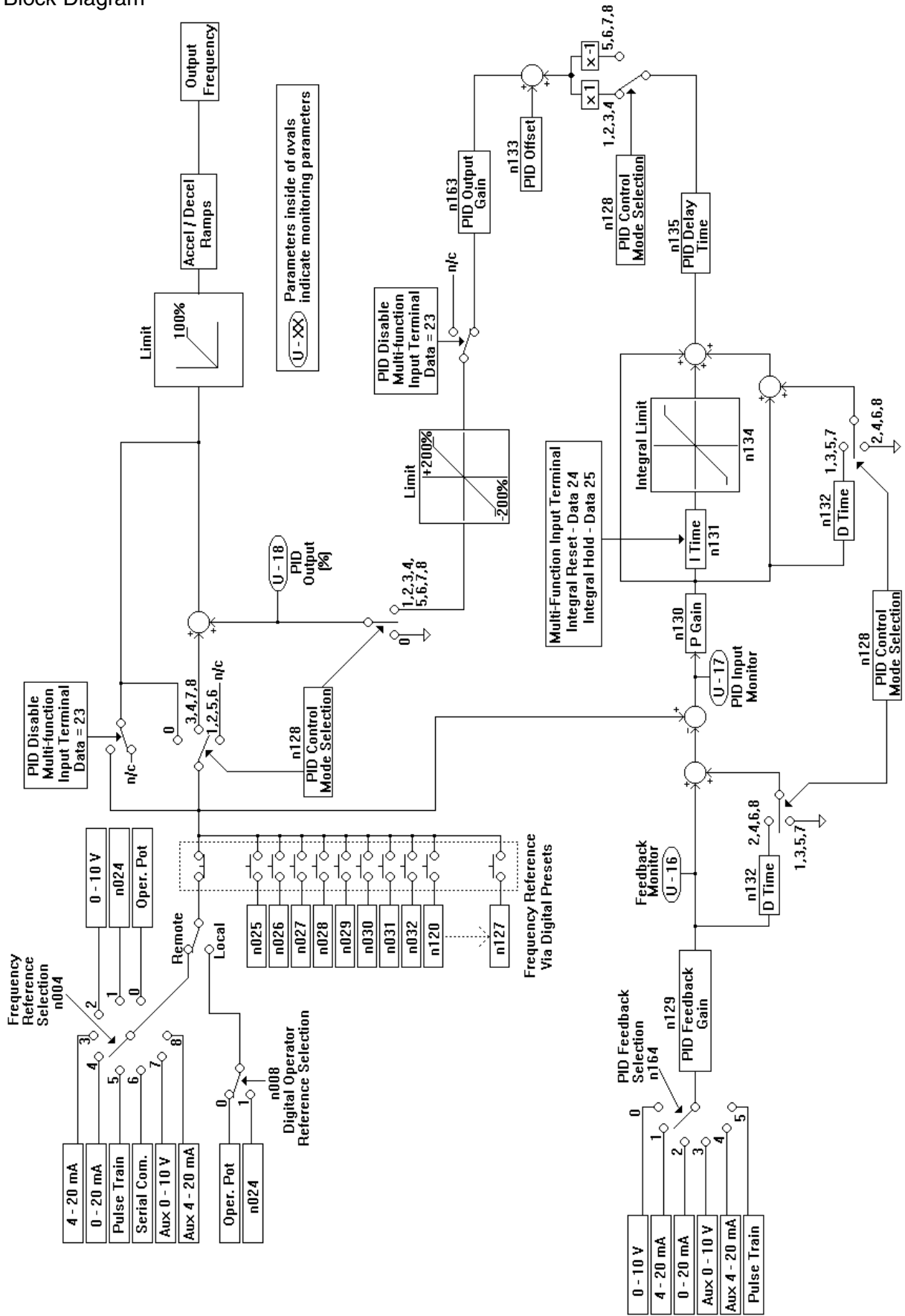

5.29 COPY FUNCTION

The standard digital operator JVOP-140 of the V7 can be used to store (upload) parameters from one drive, and copy (download) parameters to another drive. The copy function is not available on the V74X. Parameters are stored in an EEPROM on the digital operator therefore no backup power supply is necessary. The copy function can be used in most cases except the following.

- (1) *Different drive types* – The user may not copy parameters from a V7 to a J7 drive.
- (2) *Different voltage class* – The user may not copy parameters from a 230V drive to a 460V drive.
- (3) *Different control mode* – The user may not copy parameters from a drive operating in the Volts per hertz mode (n002=0) to a drive in the Open loop vector mode (n002=1).

The following parameters are not copied when capacities are different.

Parameter No.	Parameter Name	Parameter No.	Parameter Name
n011 to n017	V/f Settings	n108	Motor Leakage Inductance
n036	Motor Rated Current	n109	Torque Boost
n080	Carrier Frequency	n110	Motor No-load Current
n105	Torque Comp Iron Loss	n140	Energy Saving Gain K2
n106	Motor Rated Slip	n158	Motor Code (Energy Saving)
n107	Motor Line-to-line Resistance		

Parameters **n176**, **n177**, **n178** and **n179** are not read into the digital operator during a read command.

n176: Parameter Copy Function Selection

Factory Setting: **rdy**

Setting	Description
rdy	Drive is ready to use Copy Function
rEd	Read (or upload) all parameters from the drive and store them in the Digital Operator
Cpy	Copy (or download) all parameters stored in the Digital Operator to the drive
uFy	Verify that parameters stored in the Digital Operator and the drive are the same
uA	Displays the voltage and kW rating of the drive whose parameters are stored in the Digital Operator
Sno	Displays the software number of the drive whose parameters are stored in the Digital Operator

n177: Parameter Copy Access Selection

Factory Setting: **0**

Range: 0 or 1

Setting	Description
0	Reading Disabled
1	Reading Allowed

The Copy Function can be enabled or disabled using parameter **n177** – parameters cannot be uploaded when this parameter is disabled (**n177** = 0), preventing the accidental overwriting of parameters stored in the Digital Operator.











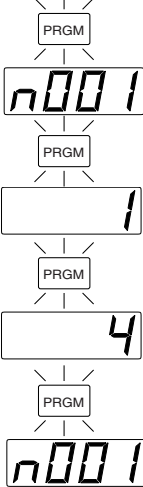

If **n177** = 0 and an upload is attempted (**n176** = rEd or Cpy), a "PrE" error message will blink on the Digital Operator display – press **DSPL** or **DATA/ENTER** to clear the message.

5.29 COPY FUNCTION

A. Read Function (rEd)

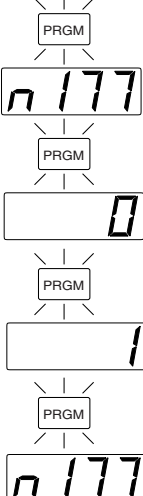
The Read function reads the available parameter data from the drive and stores them in a EEPROM in the digital operator. When the Read function is executed the previously stored parameter data is cleared and replaced with newly read parameters.

Table 5-5. Reading Drive Parameters

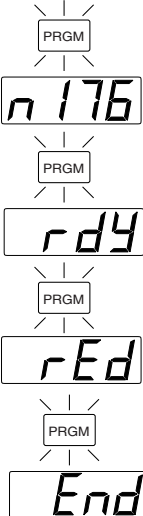
DESCRIPTION	KEY SEQUENCE	DIGITAL OPERATOR DISPLAY
<p>Set the highest parameter access level. This will allow all parameters to be viewed and set.</p>	<p>Press the  key until the  LED is lit on the digital operator.</p> <p>Press .</p> <p>Press  three times.</p> <p>Press .</p>	
<p>Set Parameter Copy Access Selection (n177) = 1</p>	<p>Press and hold  until n177 is displayed on the digital operator.</p> <p>Then press .</p> <p>Use the  key to set a "1" in the display.</p> <p>Then press .</p>	
<p>Execute upload (Read) Using Parameter Read Function Selection (n176)</p>	<p>Press the  key once.</p> <p>Then press .</p> <p>Press the  key once.</p> <p>Press . "rEd" will blink on the display while reading.</p>	

















5.29 COPY FUNCTION

Continued

B. Copy Function (Cpy)

The Copy function writes the parameters stored in the digital operator's EEPROM into the drives non-volatile memory. The Copy function is possible only for drives of the same type (i.e. from one GPD 315/V7 to another), voltage rating, and control method (V/f or open loop vector).

Table 5-6. Writing Drive Parameters









DESCRIPTION	KEY SEQUENCE	DIGITAL OPERATOR DISPLAY
<p>Set the highest parameter access level. This will allow all parameters to be viewed and set.</p>	<p>Press the  key until the  LED is lit on the digital operator.</p> <p>Press .</p> <p>Press  three times.</p> <p>Press .</p>	<p> n001</p> <p> 1</p> <p> 4</p> <p> n001</p>
<p>Execute download (Copy) Using Copy Function Selection (n176)</p>	<p>Press the  key once.</p> <p>Then press .</p> <p>Press the  key twice.</p> <p>Press . "CPY" will blink on the display while writing.</p>	<p> n176</p> <p> rdy</p> <p> CPY</p> <p> End</p>

C. Verify Function (uFy)

Compares the parameter data stored in the operator with the parameter data in the drive. VERIFY is possible only for drives of the same type (i.e. from one GPD 315/V7 to another), voltage rating, and control method (V/f or open loop vector).

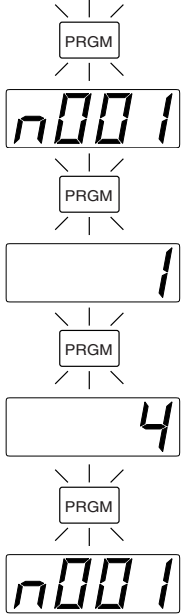
When the parameters stored in the digital operator match those in the drive, "uFy" will blink in the display for several seconds, and then "End" will be displayed. When they don't match "uAE" will be displayed. Press stop to interrupt the execution of verify, or press Data/Enter to display a list of parameters that do not match.

Table 5-7. Verifying Drive Parameters

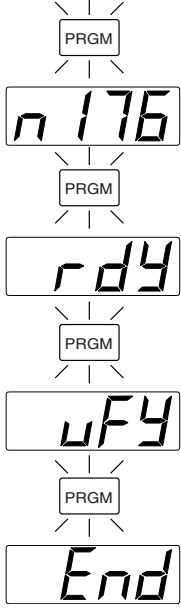
DESCRIPTION	KEY SEQUENCE	DIGITAL OPERATOR DISPLAY
<p>Set the highest parameter access level. This will allow all parameters to be viewed and set.</p>	<p>Press the  key until the  LED is lit on the digital operator.</p> <p>Press .</p> <p>Press  three times.</p> <p>Press .</p>	
<p>Execute upload (Copy) Using Copy Function Selection (n176)</p>	<p>Press and hold  until n176 is displayed on the digital operator.</p> <p>Then press .</p> <p>Press the  key three times.</p> <p>Press . "uFy" will blink on the display while verifying.</p>	

D. Drive Capacity Function (uA)

The Drive Capacity function allows the user to verify that the parameter data stored in the digital operator are from the same capacity and voltage class as the drive being written too. The voltage and the drive capacity whose parameters are stored in the digital operator are displayed on the digital operator. When “uA” is selected and Data/Enter is pressed. The value that is displayed indicates the voltage and drive capacity in kilowatts. This value can be compared to the drive specification number on the drive data nameplate.

Display	Model	
	CIMR-V7*U <input type="checkbox"/>	MV <input type="checkbox"/>
20.1	20P1	A001
20.2	20P2	A002
20.4	20P4	A003
20.7	20P7	A005
21.5	21P5	A008
22.2	22P2	A011
23.7	23P7	A017
25.5	25P5	A025
27.5	27P5	A033
40.2	40P2	B001
40.4	40P4	B002
40.7	40P7	B003
41.5	41P5	B005
42.2	42P2	—
43.7	43P7	B009
45.5	45P5	B015
47.5	47P5	B018

E. Software Number Display

The software number display allows the user to check the software revision number of the parameter data stored in the digital operator. This value can be compared to the PRG number on the drive data nameplate.

F. Copy Function message list

Operator display	Description	Corrective action
rdy	Drive is ready to perform a Copy Function	-
rEd	Read selected Flashing: Read is being performed	-
Cpy	Writing (COPY) selected Flashing: Write (Copy) is being performed	-
uFy	Verify selected Flashing: Verify is being performed	-
uA	Drive capacity selected	-
Sno	Software number displayed	-
End	Read, Copy or Verify completed	-
PrE	Flashing: Attempt to execute Read while parameter Copy Access Selection (n177) is set to " 0"	Set Parameter n177 to a value of "1"
rdE	Flashing: Parameter could not be read properly by the Read function, or, an under voltage is detected during Read	Confirm that the main circuit power supply voltage is correct, then re-execute a Read
CSE	Flashing A check sum error occurred in the parameter data stored in the digital operator	The parameter data stored in the digital operator is invalid and cannot be used. Re-execute Read to store the parameters in the digital operator
dpS	Flashing: Parameter data in the drive and in the digital operator do not match. (Ex.) Copying from a GPD 315/V7 and writing to a GPD 305/J7	Check to see if the drives are the same type
ndr	Flashing: No parameter data is stored in the digital operator	Execute a Read
CPE	Flashing: Attempt to execute a Copy or Verify between different voltage drives or a different Control Mode	Verify Voltage and Control Modes
CyE	Flashing: An under voltage is detected during a Copy execution	Confirm that the main circuit power supply voltage is correct, then-execute a Copy
F04	A check sum error occurs in the parameter data stored in the inverter	Initialize the constants. If an error occurs again, replace the inverter due to a failure of parameter memory element (EEPROM) in the drive
uAE	Flashing: Attempt Execute Verify between different drive capacities	Press the Data/Enter key to continue the execution of Verify. Press stop to interrupt the execution of Verify
.FE	Flashing: A communication error has occurred between the digital operator and the drive	Check the connection between the drive and the digital operator. If a communication error occurs be sure to re-execute Read or Copy

5.30 DIGITAL OPERATOR DISPLAY SELECTION

n035 : Operator Display Mode
Reference and Indication

Factory setting: 0
Range: 0 to 3999

This parameter determines the scaling of the Digital Operator display, for both Output Frequency and all Frequency References.

DATA	DISPLAY
0 (factory setting)	Output frequency, in increments of 0.1 Hz.
1	Output frequency, in increments of 0.1 %.
2 to 39 (no. of motor poles)	<p>Motor synchronous speed ($P = \frac{120 \times F}{N_s}$) in increments of 1 RPM (3999 max).</p> <p style="margin-left: 40px;">P = no. of motor poles F = Frequency N_s = motor synchronous speed</p> <p>NOTE: If motor synchronous speed exceeds 3999 RPM, display holds at 3999.</p>
40 to 3999	<p>Line speed or other parameter.</p> <div style="margin-left: 40px;"> $\begin{array}{c} X & X & X & X \\ \hline & & & \\ \text{---} & & & \end{array}$ <p style="margin-left: 60px;">Parameter value at maximum frequency (n011) (include leading zeroes if necessary)</p> <p style="margin-left: 60px;">Location of decimal point:</p> <p style="margin-left: 80px;">_ = _ X X X 1 = _ X X.X 2 = _ X.X X 3 = 0.X X X</p> </div> <p>EXAMPLE:</p> <p>To display Line Speed, based on 54.3 FPM at 60 Hz:</p> <p>n035 setting = " 1543 "</p>

5.31 ENERGY SAVING CONTROL

n139: Energy Saving Selection
(V/f control mode)

Factory Setting: **0**

Range: 0 or 1

To enable energy saving control, **n139** must be set to "1"

Since the parameters used in energy saving mode have been preset to the optimum values, it is not necessary to adjust them under normal operation. If the motor characteristics differ greatly from those of a standard motor, refer to the following description to change the parameters.

A. Energy Saving Control Mode

n140: Energy Saving Gain

Factory Setting: **See Table A3-1**

Range: 0.0 to 6550

This gain is used when running in energy saving control mode to calculate the voltage at which motor efficiency will be greatest, and is set as the output voltage reference. This value is preset to a typical standard motor value. As energy saving increases, output voltage also increases.

n141: Energy Saving Voltage Lower Limit (60 Hz)

Factory Setting: **50%**

Range: 0 to 120%

n142: Energy Saving Voltage Lower Limit (6 Hz)

Factory Setting: **12%**

Range: 0 to 25%

n159: Energy Saving Voltage Upper Limit (60 Hz)

Factory Setting: **120%**

Range: 0 to 120%

n160: Energy Saving Voltage Upper Limit (6 Hz)

Factory Setting: **16%**

Range: 0 to 25%

These parameters are used to set the output voltage upper and lower limits. If the voltage reference value calculated in the energy saving is below the lower limit or above the upper limit, the lower or upper limit value is used as the voltage reference value. The lower limit value is set to prevent stalling at light loads, and the upper limit is set to prevent over-excitation. Set voltage limits at 6Hz and 60Hz; a value obtained by linear interpolation should be set to any limit values other than 6Hz or 60Hz. Setting is made as a percentage of motor rated voltage.

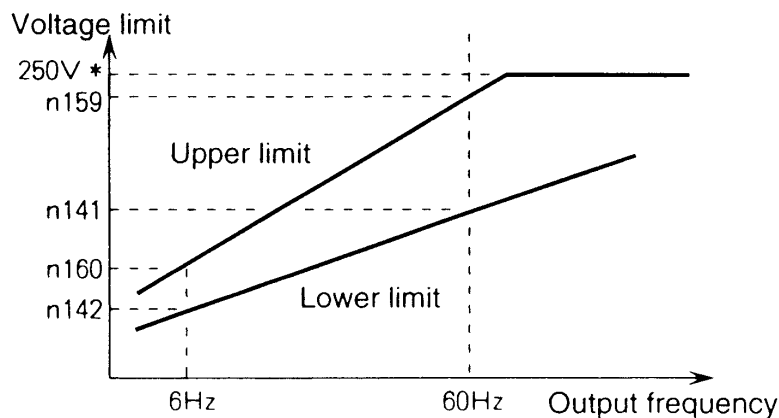

*Doubled for 460V Drives

B. Energy Saving Search Operation

In energy saving control mode, the maximum applicable voltage is calculated using the output power. However, a temperature change will change the fixed constants and the maximum applicable voltage may not be obtained.

n144: Voltage limit of tuning

Factory Setting: 0%
Range: 0 or 100%

Limits the range where the voltage can be controlled. Search operation is disabled when **n144** is set to **0**.

n145: Step Voltage of tuning to 100 % output voltage

Factory Setting: .5%
Range: 0.1 or 10%

n146: Step voltage of tuning to 5 % output voltage

Factory Setting: .2%
Range: 0.1 or 10%

n143: Time of average KW

Factory Setting: 1 (x24)
Range: 1 to 200 (x24)

Parameter **n145** & **n146** sets the voltage fluctuation for one cycle of the search operation. Increasing the values will also increase the fluctuation of the rotation speed. The value calculated by linear interpolation is set for voltages other than above.

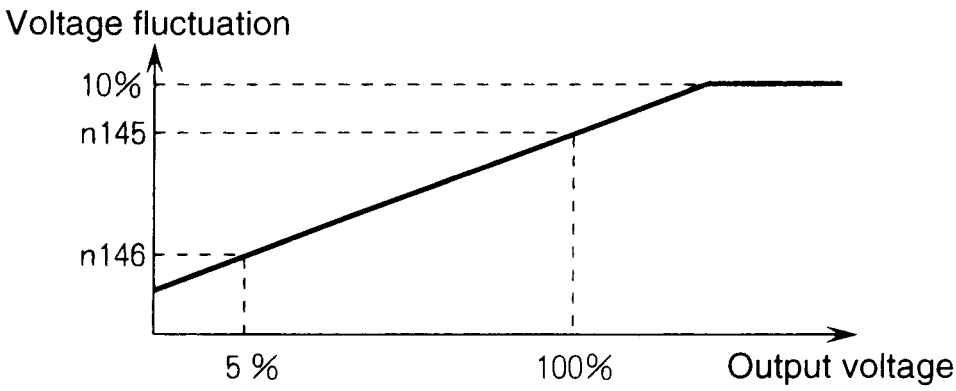

5.31 ENERGY SAVING CONTROL

Continued

n161: Power Supply Detection Hold Width

Factory Setting: **10%**

Range: 0 to 100%

When the power fluctuation is less than this value, the output voltage is held for three seconds and then the search operation mode is activated.

n162: Power Supply Detection Filter Time Constant

Factory Setting: **5 (x4ms)**

Range: 0 to 255 (x4ms)

Decreasing this value increases response during a load fluctuation. However, at low frequency, unstable operation will occur when this value is set too low.

5.32 MULTI-FUNCTION ANALOG INPUT SELECTION

n077: Multi-Function Analog Input Selection

Factory Setting: **0**

Range: 0 to 4

The 2CN input terminal on the digital operator can be used as an auxiliary analog input (0 –10V or 4 – 20 mA). The Analog Input Connector/Cable Assembly option (DS082) is required for interface with 2CN on the digital operator.

Setting	Description
0	Multi- Function Analog Input is disabled
1	Auxiliary Frequency Reference (FREF2)
2	Frequency Reference Gain (FGAIN)
3	Frequency Reference Bias (FBIAS)
4	Output Voltage Bias (VBIAS)

1) Auxiliary Frequency Reference (n077=1)

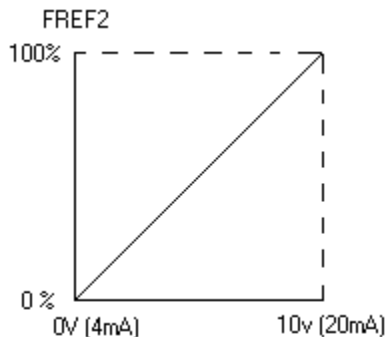

2) Frequency Reference Gain (n077=2)

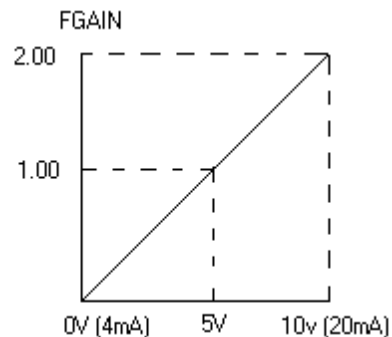

When multi-function analog input (n004 = 7 or 8) is selected, 2CN on the digital operator becomes the speed reference input. If n004 is set to any other data value, the 2CN auxiliary analog input is determined by the selection of Command A.

Frequency reference is multiplied by FGAIN, after frequency reference gain (n060 (terminal FR) or n074 (terminal RP)) and frequency reference bias (n061 (terminal FR) or n074 (terminal RP)) are used to calculate a master speed reference input at terminals FR or RP

5.32 MULTI-FUNCTION ANALOG INPUT SELECTION

Continued

3) Frequency Reference Bias (n077=3)

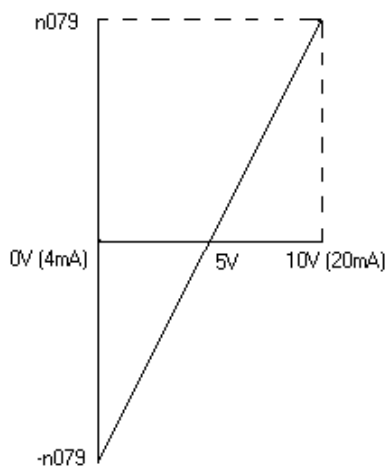

FBIAS is added to the frequency reference, after frequency reference gain (n060 (terminal FR) or n074 (terminal RP)) and frequency reference bias (n061 (terminal FR) or n075 (terminal RP)) are used to calculate master speed reference input at terminals FR or RP

4) Output Voltage Bias (n077=4)

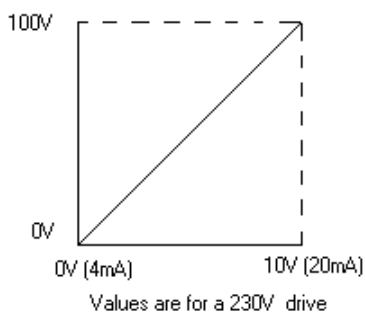

VBIAS is added to output voltage after V/f pattern is established

n078: Multi Function Analog Input Signal Selection

Factory Setting: 0
Range: 0 or 1

Setting	Description
0	2CN input terminal (0-10V input)
1	2CN input terminal (4-20mA input)

n079: Frequency Reference Bias Setting

Factory Setting: 10%
Range: 0 to 50%

This bias is used only for the auxiliary analog input.

5.33 FREQUENCY REFERENCE LOSS DETECTION

n064: Frequency Reference Loss Detection

Factory setting: **0** (disabled)

Range: 0 or 1

The reference loss detection function is either enabled or disabled, based on the setting of **n064**. When enabled (data " 1 "), the reference loss detection compares the change in reference with respect to time. If the reference decreases by 90% in more than 0.4 seconds, the drive will decelerate to the set reference; if the reference decreases by 90% in less than 0.4 seconds, the drive will continue to operate at 80% of the output frequency. To regain control of output frequency, either exceed the set reference (80% of reference) or initiate a STOP command. If Auto Reference is less than $F_{max} (n011) \times .05$, this function is not performed.

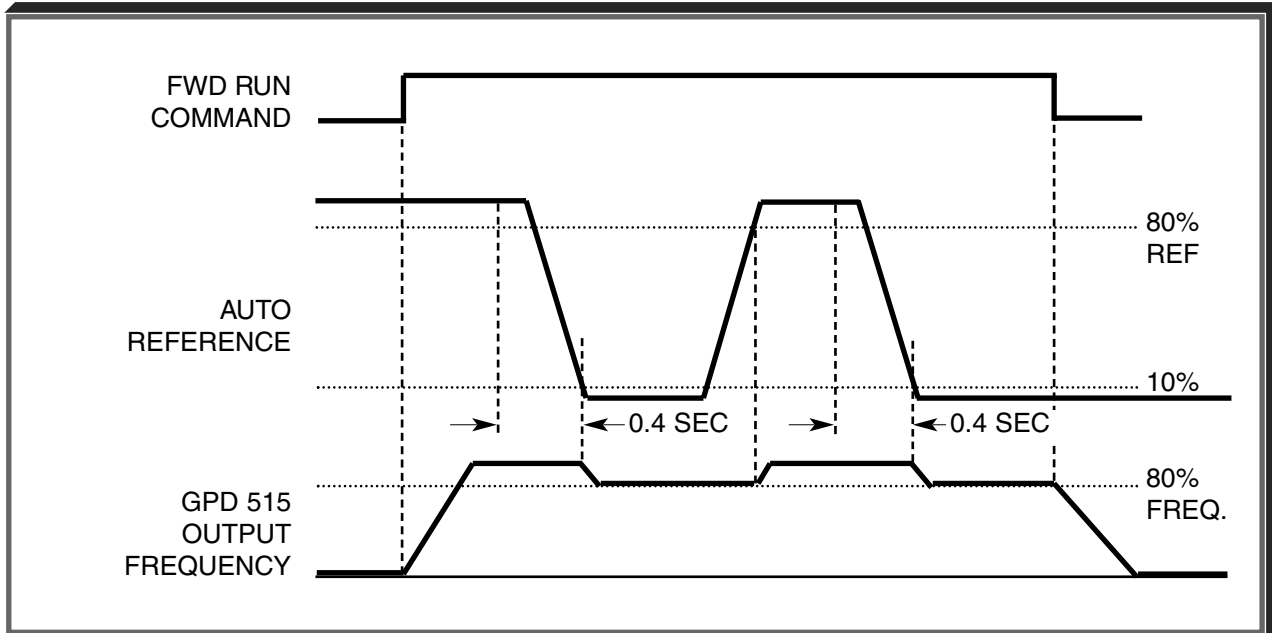

Timing Chart

Note: This function applies to frequency references at terminal **FR, RP or 2CN (Multi-Function Analog Input)**.

5.34 UNDERTORQUE DETECTION

Undertorque detection is used to compare Drive output current/torque with the undertorque detection level. When the output current is equal to or less than the defined level, an undertorque condition exists. This will be indicated as a **UL3** fault on the Digital Operator. This feature can be selected to operate over a wide range of conditions.

A. n117: Undertorque Detection

Factory setting: **0**

This constant determines whether the undertorque detection function of the Drive is enabled, under what conditions it will detect for undertorque, and what operation it will perform after detecting an undertorque.

Setting	Undertorque Disabled	Operation After Detection	Detection Condition
0	Disabled	—	—
1	Undertorque	Continues	Only at set frequency
2	Undertorque	Coast to stop	Only at set frequency
3	Undertorque	Continues	At all times except during stopping or DC injection braking
4	Undertorque	Coast to stop	At all times except during stopping or DC injection braking

5.34 UNDERTORQUE DETECTION Continued

- For undertorque detection during accel or decel, set to " 3 " or " 4 ".
- For continuous operation after undertorque detection, set to " 1 " or " 3 ". During detection, the Digital Operator displays and " **UL3** " alarm (blinking).
- To stop the drive at an undertorque detection fault, set to " 2 " or " 4 ". At detection, the Digital Operator displays an " **UL3** " fault.
- To output an undertorque detection signal, set output terminal function selection (**n057**, **n058** or **n059**) to " 8 " or " 9 ".

B. n118 : Undertorque Detection Level

Factory setting: 10 %
Range: 0 to 200 %

This is the reference point for determining that an undertorque condition exists. Set as a percent of Drive rated current or as a percent of motor rated torque.

C. n119 : Undertorque Detection Time

Factory setting: 0.1 sec.
Range: 0.1 to 10.0 seconds

Determines how long an undertorque condition must exist before another event will occur, e.g. coast to stop, multi-function output change of state, or **UL3** warning or fault display.

- D. n057 : Multi-function Output 1**
(terminals MA, MB & MC)
- n058 : Multi-function Output 2**
(terminals P1 & PC)
- n059 : Multi-function Output 3**
(terminals P2 & PC)

Data 6 or 7 : Overtorque Detection
Data 8 or 9 : Undertorque Detection

A Form-C contact, or an open collector output, can be programmed to change states during an overtorque/undertorque detection condition.

EXAMPLE OF OVERTORQUE DETECTION

- n096** setting: **2** — Overtorque enabled, only at set frequency, coast to stop
- n057** setting: **6** — Output contact programmed for overtorque detection
- n096** setting: **110 %** — Level at which overtorque is sensed
- n099** setting: **1.0 s** — Time delay before overtorque event occurs

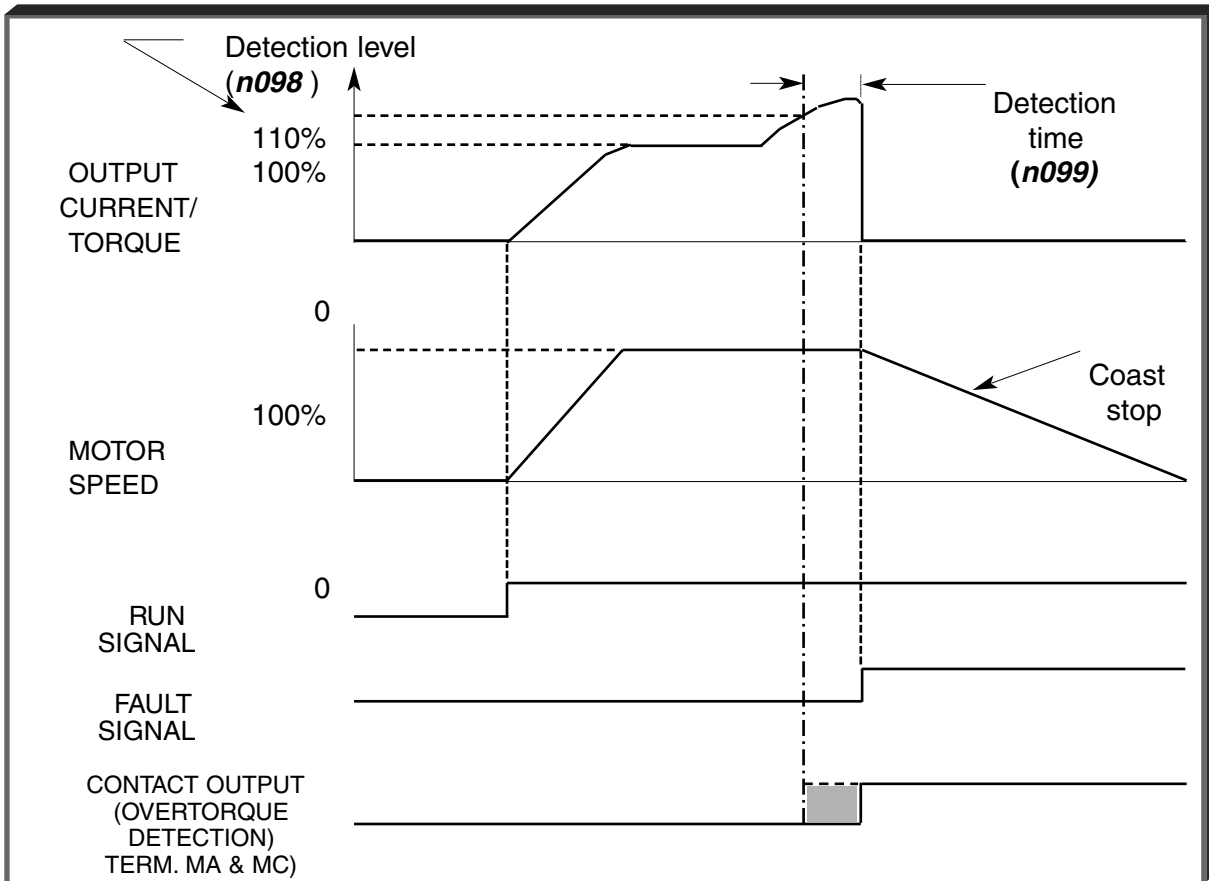

Overtorque Detection Timing Diagram

Section 6. FAULT DIAGNOSIS AND CORRECTIVE ACTIONS

6.1 GENERAL

This section describes the alarm and fault displays, explanations for fault conditions and corrective actions to be taken if the Drive malfunctions.

A failure in the Drive can fall into one of two categories, Alarm or Fault.

A blinking “Alarm” indication is a warning that a Drive trouble condition will soon occur, or that a programming error has been made. The Drive will continue to operate during an “Alarm” indication.

A blinking “Minor Fault” indication is displayed during less serious faults, or when a problem exists in the external circuitry. The Drive will continue to operate, and a “Minor Fault” contact will be closed if a multi-function output is programmed for the condition.

A steady “Major Fault” indication is displayed when the Drive’s Fault relay has tripped. The motor coasts to a stop, and a fault signal output is present at control circuit terminals 18-20.

 : ON  : BLINKING  : OFF

Table 6-1. Alarm Displays and Corrective Actions









Alarm Display		Drive Status	Explanation	Causes and Corrective Actions
Digital Operator	RUN (Green) ALARM (Red)			
 Blinking		Warning only. Fault contacts do not change state.	UV (Main circuit low voltage) Main circuit DC voltage drops below the low-voltage detection level while the drive output is OFF. 230V: Stops at main circuit DC voltage below approx. 200V (160V for single-phase) 460V: Stops at main circuit DC voltage below approx. 400 V	Check the following: <ul style="list-style-type: none"> • Power supply voltage • Main circuit power supply wiring is connected. • Terminal screws are securely tightened.
 Blinking	 		OV (Main circuit overvoltage) Main circuit DC voltage exceeds the over voltage detection level while the drive output is OFF. Detection level: approx. 410V or more (approx. 820V for 460V class).	Check the power supply voltage.
 Blinking			OH (Cooling fin overheat) Intake air temperature rises while the drive output is OFF.	Check the intake air temperature.
 Blinking	 		Warning. Fault contacts do not change state.	OH3 (Drive overheat pre-alarm) OH3 signal is input.

Table 6-1. Alarm Displays and Corrective Actions - Continued







Alarm Display		Drive Status	Explanation	Causes and Corrective Actions
Digital Operator	RUN (Green) ALARM (Red)			
<i>CAL</i> Blinking		Warning only. Fault contacts do not change state.	CAL (MODBUS communications waiting) Correct data has not been received from the PLC when the parameter n003 (operation command selection) is 2 or n004 (frequency reference selection) is 6, and power is turned ON.	Check communication devices, and transmission signals.
<i>OPE</i>  Blinking	 		OPE  (Parameter setting error when the parameter setting is performed through the MODBUS communications) OPE1: Two or more values are set for multi-function input selection. (parameters n050 to n056) OPE2: Relationship among V / f parameters is not correct. (parameters n011, n013, n014, n016) OPE3: Setting value of electronic thermal standard current exceeds 150% of drive rated current. (parameter n036) OPE4: Upper / lower limit of frequency reference is reversed. (parameters n033, n034) OPE5: (parameters n083 to n085) OPE9: Carrier frequency setting is incorrect. (parameter n080)	Check the setting values.
<i>OL3</i> Blinking			OL 3 (Overtorque detection) Motor current exceeded the preset value in parameter n098.	Reduce the load, and increase the accel / decel time.
<i>SEr</i> Blinking			SEr (Sequence error) Drive receives LOCAL / REMOTE select command or communication / control circuit terminal changing signals from the multi-function terminal while the drive output is ON.	Check the external circuit (sequence).

Table 6-1. Alarm Displays and Corrective Actions - Continued







Alarm Display		Drive Status	Explanation	Causes and Corrective Actions
Digital Operator	RUN (Green) ALARM (Red)			
<i>bb</i> Blinking			BB (External baseblock) Baseblock command at multi-function terminal is active, the drive output is shut OFF (motor coasting). Temporary condition is cleared when input command is removed.	Check the external circuit (sequence).
<i>EF</i> Blinking		Warning only. Fault contacts do not change state.	EF (Simultaneous FWD/REV run commands) When FWD and REV run commands are simultaneously input for over 500ms, the drive stops according to parameter n005.	Check the external circuit (sequence).
<i>STP</i> Blinking	or		STP (Operator function stop) is pressed during running by the control circuit terminals FWD / REV command. The drive stops according to parameter n005.	Open FWD/REV command of control circuit terminals.
	 		STP (Emergency stop) Drive receives emergency stop alarm signal. Drive stops according to parameter n005.	
<i>FbL</i> Blinking		FBL (PID feedback loss detection) PID feedback value drops below the detection level. When PID feedback loss is detected, the Drive operates according to the n136 setting.	Check the mechanical system and correct the cause, or increase the value of n137.	
<i>UL3</i>	 	Protective operation. Output is shut OFF and motor coasts to a stop.	When under torque is detected, drive performs operation according to the preset setting of constant n117.	Parameter n118 up to the lowest value allowed for the machine.
<i>UL3</i> Blinking	 	Warning. Fault contacts do not change state.	UL3 (Under torque detection) V/f mode: Drive output current fell below the preset value in parameter n118. Vector mode: Motor current or torque fell below the preset value in parameter n097 and n118.	Load (output current or output torque) is too low. Check the driven machine and correct the cause of the fault, or decrease the value of parameter n118

Table 6-2. Fault Displays and Corrective Actions

Fault Display		Drive Status	Explanation	Causes and Corrective Actions
Digital Operator	RUN (Green) ALARM (Red)			
<i>FAN</i> Blinking			FAN (Cooling fan fault) Cooling fan is locked.	Check the following: <ul style="list-style-type: none"> • Cooling fan • Cooling fan wiring is not connected.
<i>OL</i>	●	Protective Operation. Output is shut OFF and motor coasts to a stop.	OC (Overcurrent) Drive output current momentarily exceeds approx. 250% of rated current.	<ul style="list-style-type: none"> • Short circuit at drive output side • Excessive load inertia • Extremely rapid accel/ decel time (parameters n019 to n022) • Special motor used • Starting motor during coasting • Motor of a capacity greater than the drive rating has been started. • Magnetic contactor open/closed at the drive output side
<i>OU</i>	☀		OV (Main circuit over-voltage) Main circuit DC voltage exceeds the overvoltage detection level because of excessive regenerative energy from the motor. Detection level: 230V: Stops at main circuit DC voltage below approx. 410V 460V: Stops at main circuit DC voltage approx. 820V or more	<ul style="list-style-type: none"> • Insufficient decel time parameters n020 and n022) • Lowering of minus load (elevator, etc.) <p style="text-align: center;">←</p> <ul style="list-style-type: none"> • Increase decel time. • Connect optional dynamic braking resistor.
<i>UV1</i>			UV1 (Main circuit low voltage) Main circuit DC voltage drops below the low-voltage detection level while the drive output is ON. 230V: Stops at main circuit DC voltage below approx. 200V 460V: Stops at main circuit DC voltage approx. 400V or more	<ul style="list-style-type: none"> • Reduction of input power supply voltage • Open phase of input supply • Occurrence of momentary power loss <p style="text-align: center;">←</p> <p>Check the following:</p> <ul style="list-style-type: none"> • Power supply voltage • Main circuit power supply wiring is connected. • Terminal screws are securely tightened.

Table 6-2. Fault Displays and Corrective Actions - Continued

Fault Display		Drive Status	Explanation	Causes and Corrective Actions
Digital Operator	RUN (Green) ALARM (Red)			
UV2		Protective Operation. Output is shut OFF and motor coasts to a stop.	UV2 (Control power supply fault) Voltage fault of control power supply is detected.	Cycle power. If the fault remains, replace the drive.
OH			OH (Cooling fin overheat) Temperature rise because of drive overload operation or intake air temperature rise.	<ul style="list-style-type: none"> • Excessive load • Improper V/f pattern setting • Insufficient accel time if the fault occurs during acceleration • Intake air temperature exceeding 122°F (50°C) <p style="text-align: center;">←</p> Check the following: <ul style="list-style-type: none"> • Load size • V/f pattern setting (parameters n011 to n017) • Intake air temperature.
OL1	● ☀		OL1 (Motor overload) Motor overload protection operates by built-in electronic thermal overload relay.	<ul style="list-style-type: none"> • Check the load size or V/f pattern setting (parameters n011 to n017) • Set the motor rated current shown on the nameplate in parameter n036.
OL2			OL2 (Drive overload) Drive overload protection operates by built-in electronic thermal overload relay.	<ul style="list-style-type: none"> • Check the load size or V/f pattern setting (parameters n011 to n017) • Check the drive capacity.
OL3			OL3 (Overtorque detection) V/f mode: Drive output current exceeded the preset value in parameter n098. Open Loop Vector mode: Motor current or torque exceeded the preset value in parameters n097 and n098. When overtorque is detected, drive performs operation according to the preset setting of parameter n096.	Check the driven machine and correct the cause of the fault, or increase the value of parameter n098 up to the highest value allowed for the machine.

Table 6-2. Fault Displays and Corrective Actions - Continued

Fault Display		Drive Status	Explanation	Causes and Corrective Actions
Digital Operator	RUN (Green) ALARM (Red)			
EF □	● ☀	Protective Operation. Output is shut OFF and motor coasts to a stop.	EF□ (External fault) Drive receives an external fault input from control circuit terminal. EF0: External fault reference through MODBUS communications EF1: External fault input command from control circuit terminal S1 EF2: External fault input command from control circuit terminal S2 EF3: External fault input command from control circuit terminal S3 EF4: External fault input command from control circuit terminal S4 EF5: External fault input command from control circuit terminal S5 EF6: External fault input command from control circuit terminal S6 EF7: External fault input command from control circuit terminal S7	Check the external circuit (sequence).
F00			CPF-00 Drive cannot communicate with the digital operator for 5 sec. or more when power is turned ON.	Cycle power after checking the digital operator is securely mounted. If the fault remains, replace the digital operator or drive.
F01			CPF-01 Transmission fault occurred for 5 sec or more when transmission starts with the digital operator.	Cycle power after checking the digital operator is securely mounted. If the fault remains, replace the digital operator or drive.
F04			CPF-04 EEPROM fault of drive control circuit is detected.	<ul style="list-style-type: none"> Record all parameter data and initialize the constants. (Refer to paragraph 5.___ for constant initialization.) Cycle power. If the fault remains, replace the drive.

Table 6-2. Fault Displays and Corrective Actions - Continued







Fault Display		Drive Status	Explanation	Causes and Corrective Actions
Digital Operator	RUN (Green) ALARM (Red)			
F05	 	Protective Operation. Output is shut OFF and motor coasts to a stop.	CPF-05 A/D converter fault is detected.	Cycle power. If the fault remains, replace the drive.
F06			CPF-06 Option card connecting fault	Remove power to the drive. Check the connection of the digital operator.
F07			CPF-07 Operator control circuit (EEPROM or A/D converter) fault	Cycle power after checking the digital operator is securely mounted. If the fault remains, replace the digital operator or drive.
OPR			OPR (Operator connecting fault)	Cycle power. If the fault remains, replace the drive.
CE			CE (MODBUS communications fault)	Check the communication devices or communication signals.
PF			PF (Input Phase Loss) Drive input power supply has an open phase or has a large imbalance of voltage.	Check input voltage. Tighten terminal screws. Check input voltage.
LF			LF (Output Open Phase) An open phase occurred at the Drive output.	Check the wiring to the motor. Check motor for phase to ground short. Check motor impedance.
RH			RH (Dynamic Braking Resistor)	

Table 6-2. Fault Displays and Corrective Actions - Continued

Fault Display		Drive Status	Explanation	Causes and Corrective Actions
Digital Operator	RUN (Green) ALARM (Red)			
STP	  or  	Stops according to parameter	STP (Emergency stop) The drive stops according to parameter n005 after receiving the emergency stop fault signal.	Check the external circuit (sequence).
FBL			FBL (PID feedback loss detection) PID feedback value drops below the detection level. When PID feedback loss is detected, the Drive operates according to the n136 setting.	Check the mechanical system and correct the cause, or increase the value of n137.
bus			Option card communications fault Communication fault has occurred in a mode that run command and frequency reference are set from the communication option card.	Check the communication devices or communication signals for noise and power supply.
— (OFF)			<ul style="list-style-type: none"> • Insufficient power supply voltage • Control power supply fault • Hardware fault 	Check the following: <ul style="list-style-type: none"> • Power supply voltage • Main circuit power supply wiring is connected. • Terminal screws are securely tightened. • Control sequence. Replace the drive.

For display/clear of fault history, refer to page 6-8.

Note 1: This fault display only available on drive model numbers CIMR-V7AM25P51, 27P51, 45P51, and 47P51 (MVA025, MVA033, MV015, and MVB018). All other drive ratings display “0L” when a ground fault condition occurs.

6.2 Displaying Fault Sequence

When U-09 or n178 is selected, a four-digit box is displayed. The three digits from the right show a fault description code, and the digit on the left shows the order of fault (from one to four). Number 1 represents the latest fault, and 2,3,4, in ascending order of fault occurrence.













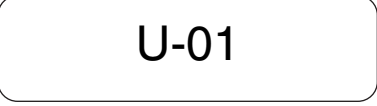

- Example
 - 4-digit numbers
 - : Order of fault (1 to 4)
 - : Fault description
 - “---” is displayed if there is no fault.
 - (Refer to section 6 for details of fault.)
- Viewing fault record
 - Press the  or  key to examine the complete fault record.
- Clearing fault record
 - Set parameter n001 to “6” to clear the fault record. Display returns to “n001” after completion of 6 setting.

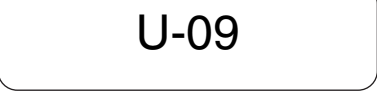
Table 6-3. Displaying Fault Sequence

STEP	OPERATION PROCEDURE	DIGITAL OPERATOR DISPLAY
1	Press  until the  LED is lit The digital operator display will read “U-01”	
2	Press  until “U-09” appears on the display.	
3	Press 	
4	Press  . The display indicates that this is currently the next code in the memory register.	
5	Continue pressing  to display the other codes in the memory register. After the last register code is displayed, the sequence will return to the first code.	  

After the fault sequence has been examined, troubleshoot the most recent fault before entering a Fault Reset command (by Digital Operator **STOP/RESET** key or external signal at multi-function input) to prepare the Drive for restart of operation.

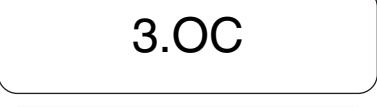
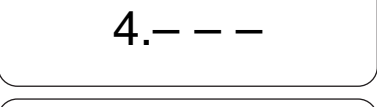
Note 1: Parameter initializing (n001=10 or 11) also clears the fault record.

Note 2: Resetting a fault from either the digital operator or multi-function input will not reset the fault record.

Appendix 1. PARAMETER LISTING

The Drive control circuits use various parameters to select functions and characteristics of the Drive. Changing of parameter settings must be done in the Program mode, or by use of the Function LEDs, if available (see Section 4).

The following table lists all parameters in numerical order. For each parameter, reference paragraph(s) in Section 5 are listed (if applicable) where the features of the Drive affected by that parameter are described.

Table A1-1. V7 Parameters

PARAMETER	NAME	SETTING RANGE (AND UNITS)	SETTING INCREMENT	FACTORY SETTING	USER SETTING	PARA. REF.
n001	Parameter Selection / Initialization	0: n001 can be read and set; n002 - n179 read only 1: n001 - n039 can be read and set 2: n001 - n079 can be read and set 3: n001 - n119 can be read and set 4: n001 - n179 can be read and set 5: n001 - n179 can be read and set Run command accepted during Program mode 6: Clear Fault History Only 7: Not Used 8: 2-wire Initialization (Japan Spec.) 9: 3-wire Initialization (Japan Spec.) 10: 2 wire initialization (USA Spec) 11: 3 wire initialization (USA Spec.)	1	1		5.21
n002	Control Method Selection	0: V/f Control 1: Open Loop Vector	1	0		2.2
n003	Operation Method Selection	0: Digital Operator 1: Terminal 2: Serial Communication (Modbus) 3: Option Card	1	1		5.13
n004	Reference Selection	0: Digital Operator Pot 1: Digital Operator 2: Voltage Reference (0 to 10V) 3: Current Reference (4 to 20 mA) 4: Current Reference (0 to 20 mA) 5: Pulse Train Reference 6: Serial Communications (Modbus) 7: Multi-Function Analog Input (0 to 10V) 8: Multi-Function Analog Input (4 to 20 mA) 9: Option Card	1	2		5.11, 5.13
n005	Stop Method	0: Ramp to stop 1: Coast to stop	1	0		5.24
n006	Reverse Prohibit	0: Reverse Run enabled 1: Reverse Run disabled ¹	0			
n007	STOP Key Function	0: STOP key is effective regardless of programming of n003 1: STOP key is effective only when sequence command (per n003) is from Digital Operator	1	0		5.13
n008	Reference Selection - Digital Operator	0: Frequency Reference from digital operator pot 1: Frequency Reference from n024	1	0		5.13
n009	Frequency Reference Setting Method From Digital Operator	0: ENTER key must be pressed to write-in new value 1: ENTER key does not have to be pressed to write-in new value	1	0		5.13
n010	Operation Selection When Digital Operator is Disconnected	0: Disabled (operation continues) 1: Enabled (motor coasts to a stop and fault is displayed)	1	0		5.15
n011	Frequency - Max.	50.0 to 400.0	0.1 (Hz)	60.0		5.27
n012	Voltage - Max.	0.1 to 255.0 (230V drive) 0.2 to 510.0 (460V drive)	0.1 (V)	230.0 460.0		
n013	Frequency - Max. Voltage Point	0.2 to 400.0	0.1 (Hz)	60.0		
n014	Frequency - Midpoint	0.1 to 399.9	0.1 (Hz)	(Note 2)		
n015	Voltage - Midpoint	0.1 to 255.0 (230V drive) 0.2 to 510.0 (460V drive)	0.1 (V)	(Note 2)		
n016	Frequency - Min.	0.1 to 10.0	0.1 (Hz)	(Note 2)		
n017	Voltage - Min.	0.1 to 50.0 (230V drive) 0.2 to 100.0 (460V drive)	0.1 (V)	(Note 2)		

Table A1-1. Drive Parameters - Continued

PARAMETER	NAME	SETTING RANGE (AND UNITS)	SETTING INCREMENT	FACTORY SETTING	USER SETTING	PARA. REF.
n018	Accel/Decel Time Setting Unit	0: 0.1 1: 0.01	1 (sec)	0		5.2
n019	Acceleration Time 1 (Note 4)	0.00 to 600.0	0.01 (sec)			5.2
n020	Deceleration Time 1 (Note 4)	or	or	10.0		
n021	Acceleration Time 2 (Note 4)	0.0 to 6000	0.1 (sec)			
n022	Deceleration Time 2 (Note 4)	(Dependent on n018 setting)				
n023	S-curve Selection	0: No S-curve 1: 0.2 second 2: 0.5 second 3: 1.0 second	1	0		5.3
n024	Frequency Reference 1 (Note 4)	0.00 to 400.00	0.01 (Hz) (< 100 Hz) or 0.1 (Hz) (>= 100 Hz)	6.00		5.11
n025	Frequency Reference 2 (Note 4)			0.00		
n026	Frequency Reference 3 (Note 4)			0.00		
n027	Frequency Reference 4 (Note 4)			0.00		
n028	Frequency Reference 5 (Note 4)			0.00		
n029	Frequency Reference 6 (Note 4)			0.00		
n030	Frequency Reference 7 (Note 4)			0.00		
n031	Frequency Reference 8 (Note 4)			0.00		
n032	Jog Frequency Reference (Note 4)			6.00		5.12
n033	Frequency Reference Upper Limit	0. to 110	1(%)	100		5.9
n034	Frequency Reference Lower Limit	0. to 110	1(%)	0		
n035	Digital Operator Display Mode	0: 0.01 Hz (less than 100 Hz) / 0.1 Hz 1: 0.1% 2 - 39: rpm 40 - 3999: custom	1	0		5.30
n036	Motor Rated Current	0.1 to 49.5 (Up to 150% of drive rated current)	0.1 (A)	(Note 1)		5.25
n037	Electronic Thermal Overload Protection (for OL1 fault)	0: Short term rating 1: Standard rating 2: Disabled	1	0		5.25
n038	Electronic Thermal Overload Protection Time Constant	1 to 60	1 (min)	8		
n039	Cooling Fan Operation Selection	0: Operates only when drive is running (continues operation for 1 minute after drive is stopped) 1: Operates with power applied to drive	1	0		
n040	Motor Rotation	0: Rotate C.C.W. 1: Rotate C.W. (or opposite direction)	1	0		5.2
n041	Acceleration Time 3 (Note 4)	0.00 to 600.00	0.01 (sec)			
n042	Deceleration Time 3 (Note 4)	or	or	10.0		
n043	Acceleration Time 4 (Note 4)	0.0 to 6000.0	0.1 (sec)			
n044	Deceleration Time 4 (Note 4)	(Dependent on n018 setting)				
n050	Multi-function Input Selection 1 (Terminal S1)	0: Fwd / Rev command (3 wire control) [can only be set in n052] 1: Forward run (2 wire control) 2: Reverse run (2 wire control) 3: External Fault (N.O.) 4: External Fault (N.C.) ¹ 5: Fault Reset	1	1 (1)		5.18
n051	Multi-function Input Selection 2 (Terminal S2)		2	(2)		
n052	Multi-function Input Selection 3 (Terminal S3)	6: Multi-step speed ref. cmd. A 7: Multi-step speed ref. cmd. B 8: Multi-step speed ref. cmd. C	1	3 (0)		

Table A1-1. Drive Parameters - Continued

PARAMETER	NAME	SETTING RANGE (AND UNITS)	SETTING INCREMENT	FACTORY SETTING	USER SETTING	PARA. REF.
n053	Multi-function Input Selection 4 (Terminal S4)	9: Multi-step speed ref. cmd. D 10: JOG Selection 11: Accel/Decel time change cmd.	1	5 (5)		5.18
n054	Multi-function Input Selection 5 (Terminal S5)	12: External Base Block (N.O.) 13: External Base Block (N.C.) 14: Speed search from max. freq.	1	6 (6)		
n055	Multi-function Input Selection 6 (Terminal S6)	15: Speed search from set freq. 16: Accel/Decel hold command 17: Remote/Local selection 18: Serial Communication / control ckt. selection	1	7 (7)		
n056	Multi-function Input Selection 7 (Terminal S7)	19: Fast Stop - Fault (N.O.) 20: Fast Stop - Alarm (N.O.) 21: Fast Stop - Fault (N.C.) 22: Fast Stop - Alarm (N.C.) 23: PID control off 24: I value reset (PID) 25: I value hold (PID) 26: Over Heat Pre-alarm OH3 27: Accel/Decel Time Select 2 34: Up	1	10 (10)		
n057	Multi-Function Output Selection 1 (Terminals MA, MB & MC)	0: Fault 1: During running 2: Speed Agree 3: Zero Speed 4: Frequency detection 1 5: Frequency detection 2	1	0		5.19
n058	Multi-Function Output Selection 2 (Terminals P1 & PC)	6: Overtorque detection (N.O.) 7: Overtorque detection (N.C.) 8: Undertorque Detection (N.O.) 9: Undertorque Detection (N.C.) 10: Minor Fault 11: During Base Block 12: Local / Remote 13: Ready	1	1		
n059	Multi-Function Output Selection 3 (Terminals P2 & PC)	14: During auto restart 15: During undervoltage 16: During reverse run 17: During speed search 18: Serial Comm. Controlled 19: PID feedback loss 20: Frequency Reference Loss Detect (N.O.) 21: Overheat Pre-alarm OH3 (N.O.)	1	2		
n060	Analog Frequency Reference Gain (term. FR to FC) (Note 4)	0 to 255	1 (%)	100		5.8
n061	Analog Frequency Reference Bias (term. FR to FC) (Note 4)	-100 to 100	1 (%)	0		
n062	Analog frequency reference filter time constant (term. FR to FC) (Note 4)	0.00 to 2.00	0.01 (sec)	0.10		
n064	Frequency Reference Loss Detection	0: No Detection 1: Continue to run at 80% of max. frequency	1	0		5.33
n065	Monitor Output0: Selection	Analog monitor output 1: Pulse monitor output	1	0		5.17
n066	Multi-function Analog Output (Terminals AM & AC)	0: Output frequency (10V = 100% Fmax) 1: Output Current (10V = 100% drive rated current) 2: DC Bus Voltage (10V = 400 VDC [800 VDC]) 3: Motor Torque (10V = Motor rated torque) 4: Output Power (10V = Drive Capacity kW) 5: Output Voltage 10V = n012 (voltage max) 6: Frequency Reference	1	0		5.17
n067	Analog Monitor Gain (Note 4)	0.00 to 2.00	0.01	1.00		
n068	Analog Frequency Reference Gain (CN2, Voltage Ref Input)	-255 to 255	1%	100		5.32
n069	Analog Frequency Reference Bias (CN2, Voltage Ref Input)	-100 to 100	1%	0		

Table A1-1. Drive Parameters - Continued

PARAMETER	NAME	SETTING RANGE (AND UNITS)	SETTING INCREMENT	FACTORY SETTING	USER SETTING	PARA. REF.
n070	Analog Frequency Reference Filter Time Constant (CN2, Voltage Ref Input)	0.00 to 2.00	0.01 s	0.10		5.32
n071	Analog Frequency Reference Gain (CN2, Current Ref Input)	-255 to 255	1%	100		
n072	Analog Frequency Reference Bias (CN2, Current Ref Input)	-100 to 100	1%	0		
n073	Analog Frequency Reference Filter Time Constant (CN2, Current Ref Input)	0.00 to 2.00	0.01 s	0.10		
n074	Pulse Train Frequency Reference Gain	-255 to 255	1%	100		5.11
n075	Pulse Train Frequency Reference Bias	-100 to 100	1%	0		
n076	Pulse Train Frequency Reference Filter Time Constant	0.00 to 2.00	0.01 s	0.10		
n077	Multi-Function Analog Input Selection	0: Multi-Function analog input disabled 1: Aux. Frequency reference 2: Frequency gain 3: Frequency bias 4: Voltage bias	1	0		5.32
n078	Multi-Function Analog Input Signal Selection	0: 0 - 10V 1: 4 - 20 mA	1	0		
n079	Multi-Function Analog Input Bias Setting	0 to 50	1%	10		
n080	Carrier Frequency	1 to 4 (x 2.5 kHz) 7 to 9 (synchronous)	1	3		5.5
n081	Momentary Power Loss Ride-through Method	0: Not Provided 1: Continuous operation after power recovery within 2 sec. 2: Continuous operation after power recovery within control logic time (no fault output)	1	0		5.16
n082	Number of auto restarts attempts	0 to 10	1	0		5.4
n083	Prohibit Frequency 1	0.00 to 400.0	0.01 (Hz) or 0.1 (Hz)	0.00		5.6
n084	Prohibit Frequency 2	0.00 to 400.0	0.01 (Hz) or 0.1 (Hz)	0.00		
n085	Prohibit Frequency 3	0.00 to 400.0	0.01 (Hz) or 0.1 (Hz)	0.00		
n086	Prohibit Frequency Deadband	0.00 to 25.50	0.01 (Hz)	0.00		
n089	DC Injection Current	0 to 100	1 (%)	50		5.7
n090	DC Injection Time at stop	0.0 to 25.5	0.1 (sec)	0.0		
n091	DC Injection Time at start	0.0 to 25.5	0.1 (sec)	0.0		
n092	Stall Prevention During Deceleration	0: Enabled 1: Disabled	1	0		5.23
n093	Stall Prevention During Acceleration	30 to 200	1 (%)	170		
n094	Stall Prevention Level During Running	30 to 200	1 (%)	160		
n095	Frequency Detection Level	0.00 to 400.0	0.01 (Hz) or 0.1 (Hz)	0.00		5.19

Table A1-1. Drive Parameters - Continued

PARAMETER	NAME	SETTING RANGE (AND UNITS)	SETTING INCREMENT	FACTORY SETTING	USER SETTING	PARA. REF.
n096	Overtorque Detection (OL3)	0: Detection Disabled 1: Detect only at set frequency; operation continues 2: Detect only at set frequency; coast to stop 3: Detect during all frequency conditions; operation continues 4: Detect during all frequency conditions; coast to stop	1	0		5.20
n097	Overtorque Detection Selection (OL3)	0: Detected by output torque 1: Detected by output current	1	0		
n098	Overtorque Detection Level (OL3)	30 to 200	1 (%)	160		
n099	Overtorque Detection Delay Time (OL3)	0.1 to 10.0	0.1 (sec)	0.1		
n100	Up/Down Hold Memory	0: Disabled 1: Enabled	1	0		5.10
n101	Speed Search Deceleration Time	0.0 to 10.0	0.1 (sec)	2		5.18
n102	Speed Search Operation Level	0 to 200%	1 (%)	150		5.18
n103	Torque Compensation Gain (Note 4)	0.0 to 2.5	0.1	1.0		5.26
n104	Torque Compensation Time Constant	0.0 to 25.5	0.1 (sec)	(Note 2)		
n105	Torque Compensation Iron Loss	0.0 to 6550	0.1 (W) or 1 (W)	(Note 1)		
n106	Motor Rated Slip (Note 4)	0.0 to 20.0	0.1 (Hz)	(Note 1)		2.2, 5.22
n107	Motor Line-to-line Resistance	0.000 to 65.50	0.001 (ohm)	(Note 1)		
n108	Motor Leakage Inductance (Note 1)	0.00 to 655.0	0.01 (mH) or 0.1 (mH)	(Note 1)		
n109	Torque Compensation Limit	0 to 250	1 (%)	150		5.26
n110	Motor No-load Current	0 to 99	1 (%)	(Note 1)		2.2
n111	Slip Compensation Gain (Note 4)	0.0 to 2.5	0.1	(Note 2)		5.22
n112	Slip Compensation Primary Delay Time	0.0 to 25.5	0.1 (sec)	(Note 2)		
n113	Slip Compensation Selection During Regeneration	0: Disabled 1: Enabled	1	0		
n115	Stall Prevention Above Base Speed During Run	0: Disabled (level is based on setting of n094) 1: Enabled (level at Fmax is n094 x 0.4)	1	0		5.23
n116	Stall Prevention During Run, Accel/Decel Time Select	0: Follows acc/dec #1 (n019, n020) or acc/dec #2 (n021, n022) Note: Multi-Function input selectable 1: Follows acc/dec #2 (n021, n022) always	1	0		
n117	Undertorque Detection Select (UL3)	0: Undertorque detection disabled 1: Detected during constant speed running. Operation continues after detection 2: Detected during constant speed running. Operation stops during detection 3: Detected during all frequency conditions. Operation continues 4: Detected during all frequency conditions. coast to stop	1	0		5.34
n118	Undertorque Detection Level (UL3)	0 to 200% Inverter rated current = 100%; if n097 = 0 (detection by torque); motor rated torque becomes 100%	1(%)	0		
n119	Undertorque Detection Time (UL3)	0.1 to 10.0	0.1 (sec)	0.1		
n120	Frequency Reference 9 (Note 4)	0.00 to 400.00		0.00		5.11
n121	Frequency Reference 10 (Note 4)		0.01 (Hz)	0.00		
n122	Frequency Reference 11 (Note 4)		(< 100 Hz)	0.00		
n123	Frequency Reference 12 (Note 4)		or	0.00		
n124	Frequency Reference 13 (Note 4)		0.1 (Hz)	0.00		
n125	Frequency Reference 14 (Note 4)		(>= 100 Hz)	0.00		
n126	Frequency Reference 15 (Note 4)			0.00		
n127	Frequency Reference 16 (Note 4)			0.00		

Table A1-1. Drive Parameters - Continued

PARAMETER	NAME	SETTING RANGE (AND UNITS)	SETTING INCREMENT	FACTORY SETTING	USER SETTING	PARA. REF.
n128	PID Control Selection	0: PID control disabled 1: D = Feed Forward 2: D = Feedback 3: Reference + PID (D = Feed Forward) 4: Reference + PID (D = Feedback) 5: Inverse PID - D = Feed Forward 6: Inverse PID - D = Feedback 7: Inverse PID - Reference + PID (D = Feed Forward) 8: Inverse PID - Reference + PID (D = Feedback)	1	0		5.28
n129	PID Feedback Gain (Note 4)	0.00 to 10.00	0.01	1.00		
n130	PID Proportional Gain (Note 4)	0.00 to 25.00	0.1	1.0		
n131	PID Integral Time (Note 4)	0.00 to 360.00	0.1 s	1.0		
n132	PID Derivative Time (Note 4)	0.00 to 2.50	0.01	0.00		
n133	PID Offset Adjustment (Note 4)	-100 to 100	1%	0		
n134	Integral Value Limit (Note 4)	-100 to 100	1%	100		
n135	PID Output Lag Filter Time (Note 4)	0.0 to 10.0	0.1 s	0.0		
n136	Feedback Loss Detection Selection (<i>Fb</i>)	0: Disabled 1: Enabled - Alarm (operation continues) 2: Enabled Fault (coast to stop)	1	0		5.31
n137	Feedback Loss Detection Level	0 to 100	1%	0		
n138	Feedback Loss Detection Time	0.0 to 25.5	0.1 s	1.0		
n139	Energy Saving Selection (Note 2) (Energy Saving)	0: Energy saving disabled 1: Energy saving enabled Note: Energy saving becomes enabled by V/f control mode	1	0		
n140	Energy Saving Gain K2 (Energy Saving)	0.00 to 6550	0.1 or 1	(Note 1)		
n141	Energy Saving Voltage Lower Limit at 60 Hz (Energy Saving)	0 to 120	1%	50		
n142	Energy Saving Voltage Lower Limit at 6 Hz (Energy Saving)	0 to 25	1%	12		
n143	Time of Average kW (Energy Saving)	1 to 200	1 (x 24 ms)	1 (24 ms)		
n144	Voltage Limit of Tuning (Energy Saving)	1 to 100	1%	0		
n145	Step Voltage of Tuning to 100% Output Voltage (Energy Saving)	0.1 to 10.0	0.1%	0.5		5.11
n146	Step Voltage of Tuning to 5% Output Voltage (Energy Saving)	0.1 to 10.0	0.1%	0.2		
n149	Pulse Train Input Scaling	100 to 3300	1 (x 10 Hz)	3072 (30,720 Hz)		
n150	Pulse Monitor Output Frequency Selection	Output Frequency Monitor: 0: 1440 Hz / Max. output frequency 1: 1f output 6: 6f output 12: 12f output 24: 24f output 36: 36f output Frequency Reference Monitor: 40: 1440Hz / Max. output frequency 41: Frequency reference * 1 42: Frequency reference * 6 43: Frequency reference * 12 44: Frequency reference * 24 45: Frequency reference * 36	0, 1, 6, 12, 24, 36, 40, 41, 42, 43, 44, 45	0		5.17
n151	Modbus Time Out Detection	0: Fault - Coast to stop 1: Fault - Ramp to stop (n020) 2: Fault - Ramp to stop (n022) 3: Alarm - operation continues 4: Disabled	1	0		5.14

Table A1-1. Drive Parameters - Continued

PARAMETER	NAME	SETTING RANGE (AND UNITS)	SETTING INCREMENT	FACTORY SETTING	USER SETTING	PARA. REF.
n152	Modbus Frequency Reference Unit2:	0: 0.1 Hz 1: 0.01 Hz 30000/100% 3: 0.1 %	1	0		5.14
n153	Modbus Slave Address	0 to 32	1	0		
n154	Modbus Baud Rate	0: 2400 bps 1: 4800 bps 2: 9600 bps 3: 19200 bps	1	2		
n155	Modbus Parity Selection	0: even parity 1: odd parity 2: no parity	1	2		
n156	Modbus Send Waiting Time	10 to 65	1 (msec)	10		
n157	Modbus RTS control	0: RTS control enabled 1: RTS control disabled 1 (RS-422A 1 to 1 communication)	0			
n158	Motor Code	0 to 70	1	(Note 1)		
n159	Energy Saving Voltage Upper Limit At 60 Hz (Energy Saving)	0 to 120	1%	120		5.31
n160	Energy Saving Voltage Upper Limit At 6 Hz (Energy Saving)	0 to 25	1%	16		
n161	Power Supply Detection Hold Width (Energy Saving)	0 to 100	1%	10		
n162	Power Supply Detection Filter Time Constant	0 to 255	1 (x 4 ms)	5 (20 ms)		
n163	PID Output Gain	0.0 to 25.0	0.1	1.0		5.28
n164	PID Feedback Selection	0: Terminal FR (Voltage 0 - 10V) 1: Terminal FR (Current 4 - 20mA) 2: Terminal FR (Current 0 - 20mA) 3: Multi-Function Analog Input (Voltage 0 - 10V) 4: Multi-Function Analog Input (Current 4 - 20mA) 5: Pulse input	1	0		
n166	Input Phase Loss Detection Level	0 to 100 (%)	1%	0		
n167	Input Phase Loss Detection Time	0 to 255 (sec)	1 sec	0		
n168	Output Phase Loss Detection Level	0 to 100 (%)	1%	0		
n169	Output Phase Loss Detection Time	0.0 to 2.0 (sec)	0.1 sec	0		
n173	DC Injection P Gain	1 to 999	1 (0.001)	83 (0.083)		
n174	DC Injection I Time	1 to 250	1 (4ms)	25 (100ms)		
n175	Reduce Carrier at low speed selection	0: Disabled 1: Carrier Frequency reduced to 2.5kHz when Fout <= 5Hz & Iout >= 110%	1	0		5.5
n176	Digital Operator Parameter Copy Function Selection	rdy : READY status rEd: READ executes Cpy: COPY executes vFy: VERIFY executes vFy vA: Inverter capacity display Sno: Software No. displaySno	rdy rEd Cpy vA	rdy		5.29
n177	Digital Operator Parameter copy Access Selection	0: Read disabled 1: Read allowed	1	0		5.29
n178	Fault History	(Note 3)	N/A	N/A		6.2
n179	Software Number	(Note 3)	N/A	N/A		4.4

Note 1: Factory setting differs depending on V7 capacity. See Appendix 3-1.

Note 2: Factory setting differs depending on control method selected (n002). See Appendix 3-1.

Note 3: n178 and n179 are display only parameters

Note 4: Parameter can be changed while V7 is operating.

Appendix 2. SPECIFICATIONS

Table A2-1. Standard Specifications

SECTION A. Model No. Related Specifications											
230V		Class									
Model	CIMR-V7* <input type="checkbox"/>	20P1	20P2	20P4	20P7	21P5	22P2	23P7	25P5	27P5	
	MV <input type="checkbox"/>	A001	A002	A003	A005	A008	A011	A017	A025	A033	
Output Characteristics	Max. applicable motor output HP (1)	1/8	1/4	1/2	3/4&1	2	3	5	7.5	10	
	Drive capacity (kVA)	0.3	0.6	1.1	1.9	3.0	4.2	6.7	9.5	13	
	Rated Output Current (A)	0.8	1.6	3.0	5.0	8.0	11.0	17.5	25	33 ⁽⁵⁾	
	Rated Input Current (A)	1.1	1.8	3.9	6.4	11.0	15.1	24.0	33.0	39.6	
	Max. Output Voltage (V)	200 to 230V (proportional to input voltage)									
	Max. Output Frequency (Hz)	400 Hz (programmable)									
Power Supply	Rated Input Voltage and Frequency	3-phase. 200 to 230 V, 50/60 Hz									
	Allowable voltage fluctuation	-15% to +10%									
	Allowable frequency fluctuation	±5%									
Physical Characteristics	Cooling Method (QTY)	NEMA 1	self	self	self	fan	fan	fan	fan	fan(2)	fan(2)
		NEMA 4	self	self	self	self	fan	fan	fan	self	self
460V		Class									
Model	CIMR-V7* <input type="checkbox"/>	--	40P2	40P4	40P7	41P5	42P2	43P7	45P5	47P5	
	MV <input type="checkbox"/>	--	B001	B002	B003	B005	--	B009	B015	--	
Output Characteristics	Max. applicable motor output HP (1)	--	1/2	3/4	1&2	3	3	5	7.5 & 10	15 ⁽⁶⁾	
	Drive capacity (kVA)	--	0.9	1.4	2.6	3.7	4.2	7	11	16 ⁽⁶⁾	
	Rated Output Current (A)	--	1.2	1.8	3.4	4.8	5.5	8.6	14.8	21 ⁽⁶⁾	
	Rated Input Current (A)	--	1.6	2.4	4.7	7.0	8.1	12.0	19.6	27.8 ⁽⁶⁾	
	Max. Output Voltage (V)	380 to 460V (proportional to input voltage)									
	Max. Output Frequency (Hz)	400 Hz (programmable)									
Power Supply	Rated Input Voltage and Frequency	3-phase. 380 to 460 V, 50/60 Hz									
	Allowable voltage fluctuation	-15% to +10%									
	Allowable frequency fluctuation	±5%									
Physical Characteristics	Cooling Method (QTY)	NEMA 1	--	self	self	self	fan	fan	fan	fan(2)	fan(2)
		NEMA 4	--	self	self	self	fan	fan	fan	self	self
SECTION B. All Drives											
Control Characteristics	Control method	Sine wave PWM (V/f Control or Open Loop Vector)									
	Frequency control range	0.1 to 400 Hz									
	Frequency accuracy (temperature change)	Digital command: ±0.01% (14 to 122°F, -10 to +50°C)									
		Analog command: ±0.5% (77°F ± 18°F, 25°C ± 10°C)									
	Speed Regulation	Open Loop Vector: ±0.2%									
		V/Hz Mode: ±0.5% – 1% with Slip Compensation									
	Frequency setting resolution	Digital Operator reference: 0.01 Hz (< 100Hz)									
		0.1 Hz (100Hz or more)									
	Output frequency resolution	Analog reference: 0.06Hz/60Hz (1/1000)									
		0.01 Hz									
	Overload capacity	150% of rated output current for 1 minute									
	Frequency Reference Signal	0 to 10VDC (20kΩ), 4 to 20mA (250Ω), 0 to 20mA (250Ω) pulse train input, Digital Operator Pot									
	Accel/Decel Time	0.01 to 6000 sec. (accel/decel time are independently programmed)									
Braking Torque	Short-term average deceleration torque (2)										
	0.2kW: 150%										
	0.75kW: 100%										
	1.5kW: 50%										
V/f characteristics	2.2kW or more: 20%										
	Continuous regenerative torque: Approx. 20% (150% with optional braking resistor, braking transistor built-in)										
Custom V/f pattern											

See notes at end of table.

(table continued on next page)

Table A2-1. Standard Specifications (Continued)

SECTION B. All Drives (Continued)			
Protective Functions	Motor overload protection	Electronic thermal overload relay	
	Instantaneous overcurrent	Motor coasts to stop at approx. 250% of drive current	
	Overload	Motor coasts to stop after 1 min. at 150% of drive rated current (7)	
	Overvoltage	Motor coasts to stop if DC bus voltage exceeds 410VDC (230V), 820VDC (460V)	
	Undervoltage	Motor coasts to stop when DC bus voltage is 210VDC or less (230V), 400VDC or less (460V)	
	Momentary Power Loss	The following operations are selectable: <ul style="list-style-type: none"> • Not provided (stops if power loss is 15 ms or longer) • Automatic restart at recovery from 0.5 sec. power loss • Automatic restart 	
	Heatsink overheat	Protected by electronic circuit	
	Stall prevention level	Independently programmable during accel and constant-speed running. Selectable during decel.	
	Ground fault	Protected by electronic circuit (overcurrent level)	
	Power charge indication	ON until the DC bus voltage becomes 50V or less. RUN lamp says ON or digital operator LED stays ON. (Charge LED is Provided for 400V)	
	Cooling Fan Fault	Protected by electronic circuit	
Other Functions	Input signals	Run/stop input	2-Wire or 3-Wire
		Multi-function input	Seven of the following input signals are selectable: Forward/reverse run (3-Wire sequence), fault reset, external fault (NO/NC contact input), multi-step speed operation, Jog command, accel/decel time select, external baseblock (NO/NC contact input), speed search command, accel/decel hold command, LOCAL/REMOTE selection, communication/control circuit terminal selection, emergency stop fault emergency stop alarm
	Output signals	Multi-function output	Following output signals are selectable (1 NO/NC contact output, 2 photo-coupler outputs): Fault, running, zero speed, at frequency, frequency detection (output frequency \leq or \geq set value), during overtorque detection, during undervoltage detection, minor error, during baseblock, operation mode, inverter run ready, during fault retry, during UV, during speed search, data output through communication
		Analog monitor	0 to +10VDC output, programmable for output frequency or output current
	Standard functions	Open Loop Vector Control, full-range automatic torque boost, auto restart, upper/lower frequency limit, DC injection braking current/time at start/stop, frequency reference gain/bias, prohibited frequencies, analog meter calibrating gain, S-curve accel/decel, slip compensation, MODBUS communications (RS485/422, Max. 19.2K bps), frequency reference from digital operator pot	
	Display	Status indicator LEDs	RUN and ALARM LEDs provided as standard
		Digital Operator	Monitors frequency reference, output frequency, output current, FWD/REF selection
	Terminals	Screw terminals for both main circuit and control circuit	
	Wiring distance between drive and motor	328 ft (100 m) or less (3)	
	Enclosure	Open Type/NEMA type 1/NEMA type 4X/12	
	Cooling method	Self-cooling/cooling fan	
Environmental conditions	Ambient temperature	14 to 104°F (-10 to 40°C)	
	Humidity	95% RH or less (non-condensing)	
	Storage temperature (4)	-4 to 140°F (-20 to 60°C)	
	Location	Indoor (free from corrosive gases or dust)	
	Elevation	3,280 feet (1,000 m) or less	
	Vibration	Up to 1G, at less than 20 Hz; up to 0.2G, at 20 to 50 Hz	

NOTES:

- (1) Based on an N.E.C. standard 4-pole motor for max. applicable motor output.
- (2) Shows deceleration torque for an uncoupled motor decelerating from 60 Hz in 0.1 seconds.
- (3) Contact Yaskawa for wiring distances greater than 328 ft. (100 m).
- (4) Temperature during shipping (for short periods of time).
- (5) On NEMA type 4X/12 model only, maximum continuous rating of 30.8 A is 40 degrees C maximum ambient. For 33.0 A maximum continuous rating, maximum ambient is 32 degrees C.
- (6) Applies to NEMA type 4X/12 model only.
- (7) On Model 47P5 NEMA type 4X/12 (21A), overload is 120% for 1 minute.

Appendix 3. CAPACITY & CONTROL METHOD RELATED PARAMETERS

The factory setting of certain parameters change with drive rating and control method selected. The following two tables list the parameters and how they change.

Table A3-1. Parameters Related to Drive Capacity

Model		n036	n105	n106	n107	n108	n110	n140	n158
CIMR-V7*U	MV								
20P1	A001	0.6	1.7	2.5	17.99	110.4	72	481.7	0
20P2	A002	1.1	3.4	2.6	10.28	56.08	73	356.9	1
20P4	A003	1.9	4.2	2.9	4.573	42.21	62	288.2	2
20P7	A005	3.3	6.5	2.5	2.575	19.07	55	223.7	3
21P5	A008	6.2	11.1	2.6	1.233	13.40	45	169.4	4
22P2	A011	8.5	11.8	2.9	0.800	9.81	35	156.8	5
23P7	A017	14.1	19.0	3.3	0.385	6.34	32	122.9	7
25P5	A025	19.6	28.8	1.5	0.199	4.22	26	94.8	9
27P5	A033	26.6	43.9	1.3	0.111	2.65	30	72.7	10
40P2	B001	0.6	3.4	2.5	41.97	224.3	73	713.8	21
40P4	B002	1.0	4.0	2.7	19.08	168.8	63	576.4	22
40P7	B003	1.6	6.1	2.6	11.22	80.76	52	447.4	23
41P5	B005	3.1	11.0	2.5	5.044	53.25	45	338.8	24
42P2	—	4.2	11.7	3.0	3.244	40.03	35	313.6	25
43P7	B009	7.0	19.3	3.2	1.514	24.84	33	245.8	27
45P5	B015	9.8	28.8	1.5	0.797	16.87	26	189.5	29
47P5	—	13.3	43.9	1.3	0.443	10.59	30	145.4	30

Table A3-2. Parameters Related to Control Method

Parameter	Description	V/f Control Mode (n002 = 0)	Open Loop Vector (n002 = 1)
n014	Frequency - Midpoint	1.5	3.0
n015	Voltage - Midpoint	12.0 (230V) 24.0 (460V)	11.0 (230V) 22.0 (460V)
n016	Frequency - Min.	1.5	1.0
n017	Voltage - Min.	12.0 (230) 24.0 (460)	4.3 (230) 8.6 (460)
n097	Overtorque Detection Selection	0.0	N/A
n104	Torque Compensation Time	0.3	0.2
n108	Motor Leakage Inductance	N/A	See table A3-1
n109	Torque Compensation Limit	N/A	150
n111	Slip Compensation Gain	0.0	1.0
n112	Slip Compensation Time	2.0	0.2
n113	Slip Compensation Selection During Regeneration	N/A	0.0
n139	Energy Saving Selection	0.0	N/A

Appendix 4. PERIPHERAL DEVICES

The following peripheral devices may be required to be mounted between the AC main circuit power supply and the Drive input terminals L1 (R), L2 (S) and L3 (T).

CAUTION

Never connect a general LC/RC noise filter to the drive output circuit.

Never connect a phase-advancing capacitor to the input/output sides or a surge suppressor to the output side of the drive.

When a magnetic contactor is installed between the drive and the motor, never turn it on or off during operation.

For more details on peripheral devices, contact your manufacturer.

Recommended Branch Circuit Short Circuit Protection Peripheral Devices

WARNING

All NEMA type 4X/12 models require branch circuit short circuit protection in the form of fuses. Use the recommended fuses listed below. Failure to use the listed fuses may result in damage to the drive and/or personal injury. All other non-NEMA type 4 Drives can use either fuses or MCCBs for branch circuit short circuit protection.

All models have UL evaluated motor overload protection built in. Motor overload protection is also provided in accordance with the NEC and CEC. Additional branch circuit overload protection is not required.

230V 3-Phase

Model	CIMR-V7* <input type="checkbox"/>	20P1	20P2	20P4	20P7	21P5	22P2	23P7	25P5	27P5
	MV <input type="checkbox"/>	A001	A002	A003	A005	A008	A011	A017	A025	A033
Capacity (kVA)		0.3	0.6	1.1	1.9	3.0	4.2	6.7	9.5	13.0
Rated output current (A)		0.8	1.6	3.0	5.0	8.0	11.0	17.5	25.0	33.0
Rated input current (A)		1.1	1.8	3.9	6.4	11.0	15.1	24.0	33.0	39.6
Max. Time Delay Fuse Rating (A) ⁽¹⁾		1.8	3.2	6.25	10	17.5	20	25	45	60
Max. Non-Time Delay Fuse Rating (A) ⁽²⁾		3	5	10	20	30	45	45	70	80
Max. MCCB Rating (A)		15	15	15	15	20	30	40	50	60

460V 3-Phase

Model	CIMR-V7* <input type="checkbox"/>	40P2	40P4	40P7	41P5	42P2	43P7	45P5	47P5 ⁽³⁾
	MV <input type="checkbox"/>	B001	B002	B003	B005	—	B009	B015	B018
Capacity (kVA)		0.9	1.4	2.6	3.7		7.0	11.0	14.0
Rated output current (A)		1.2	1.8	3.4	4.8		9.2	14.8	18/21
Rated input current (A)		1.6	2.4	4.7	7.0		12.0	19.6	23.8 / 27.8
Max. Time Delay Fuse Rating (A) ⁽¹⁾		2.8	4	8	12		20	35	45
Max. Non-Time Delay Fuse Rating (A) ⁽²⁾		5	7	12	20		35	60	70
Max. MCCB Rating (A)		15	15	15	15		20	30	40

Notes:

⁽¹⁾ Apply UL designated Class RK5 fuses.

⁽²⁾ Apply UL designated Class CC or T non-time delay fuses.

⁽³⁾ Model 47P5 rated 21A is only applicable to the NEMA type 4X/12 version.

Input fuse sizes are determined by NEC guidelines, and should not exceed the ratings shown in the table.

Fuse Ratings are based upon 250V fuses for 230V Drives, and 600V for 460V Drives

Fuse Manufacturer's Designators: Class CC: KTK, FNQ or equivalent
Class RK5: FRN, FRS or equivalent
Class T: JJS, JJN or equivalent

- **Magnetic contactor**

Mount a surge protector on the coil. When using a magnetic contactor to start and stop the drive, do not exceed one start per hour.

- **Ground fault interrupter**

Select a ground fault interrupter not affected by high frequencies. To prevent malfunctions, the current should be 200mA or more and the operating time 0.1 second or more.

- **AC and DC reactor**

Install a reactor to connect to a power supply transformer of large capacity (600 kVA or more) or to improve the power factor on the power supply side.

- **Noise filter**

Use a noise filter exclusively for the drive if radio noise generated from the drive causes other control devices to malfunction.

Appendix 5. DRIVE DIMENSIONS

Fig. 1

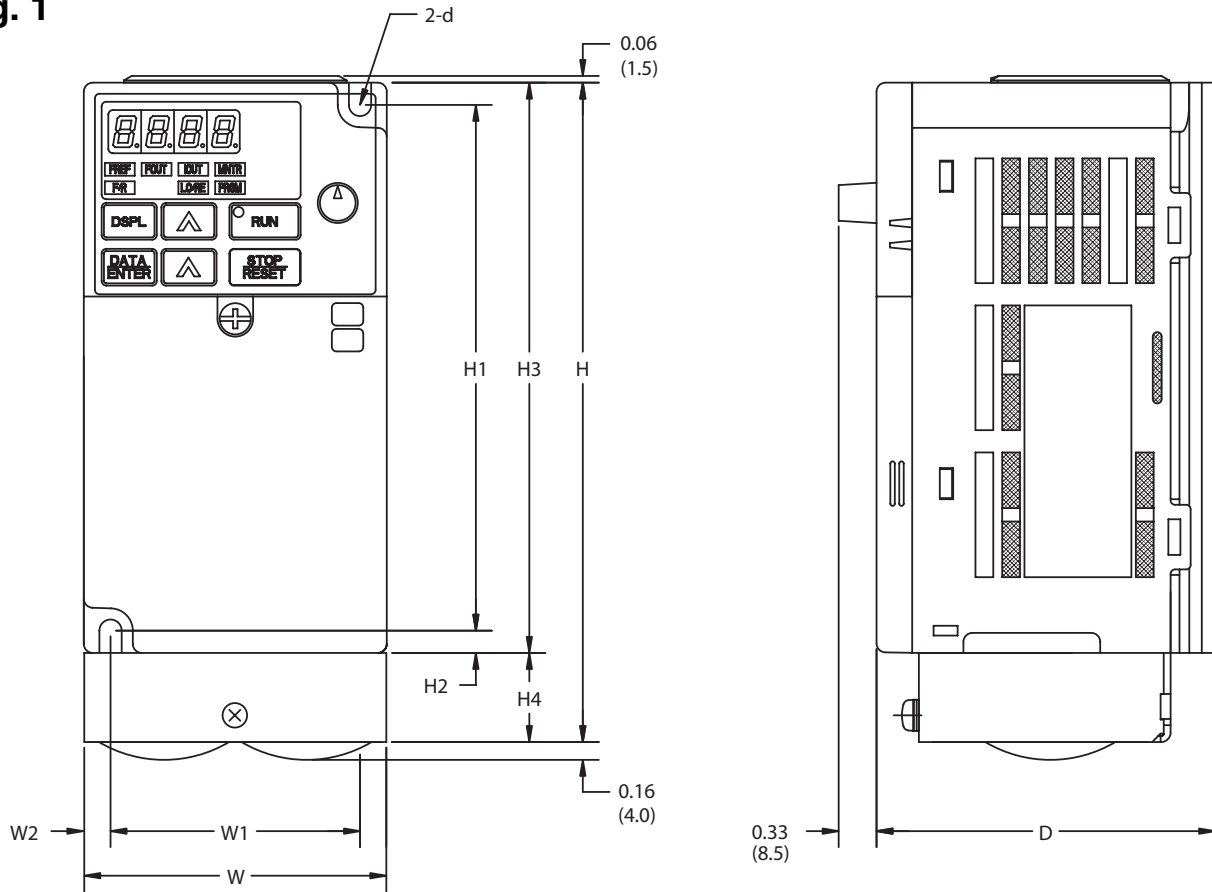

V7 Enclosed wall mounted type (NEMA type 1)

Voltage Class	Model		Size	Dimensions in inches (mm)										Weight Lbs. (kg)	Heat Loss (W)			Fig.
	CIMR-V7*	MV		HP	W	H	D	W1	H1	H2	W2	H3	H4		d	Heat-sink	Internal	
230V 3-phase	20P1	A001	1/8	2.68 (68)	5.83 (148)	2.99 (76)	2.20 (56)	4.65 (118)	0.20 (5)	0.24 (6)	5.04 (128)	0.79 (20)	M4	1.55 (0.7)	3.7	9.3	13.0	1
	20P2	A002	1/4	2.68 (68)	5.83 (148)	2.99 (76)	2.20 (56)	4.65 (118)	0.20 (5)	0.24 (6)	5.04 (128)	0.79 (20)	M4	1.55 (0.7)	7.7	10.3	18.0	1
	20P4	A003	1/2	2.68 (68)	5.83 (148)	4.25 (108)	2.20 (56)	4.65 (118)	0.20 (5)	0.24 (6)	5.04 (128)	0.79 (20)	M4	2.20 (1.0)	15.8	12.3	28.1	1
	20P7	A005	3/4 & 1	2.68 (68)	5.83 (148)	5.04 (128)	2.20 (56)	4.65 (118)	0.20 (5)	0.24 (6)	5.04 (128)	0.79 (20)	M4	2.65 (1.2)	28.4	16.7	45.1	1

(1) When drives include network communications option board, add 1.5" to drive depth.

Fig. 2

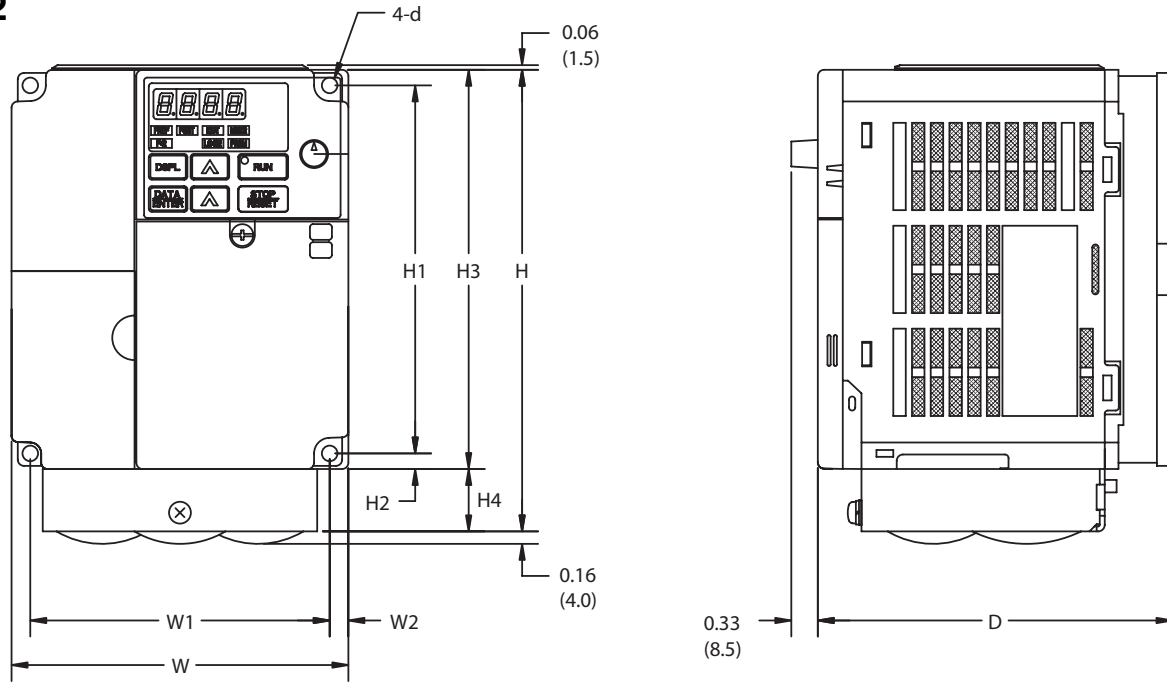

V7 Enclosed wall mounted type (NEMA type 1)

Voltage Class	Model		Size	Dimensions in inches (mm)										Weight Lbs. (kg)	Heat Loss (W)			Fig.
	CIMR-V7* V7* <input type="checkbox"/>	MV <input type="checkbox"/>		HP	W	H	D	W1	H1	H2	W2	H3	H4		d	Heat-sink	Internal	
230V 3-phase	21P5	A008	2	4.25 (108)	5.83 (148)	5.16 (131)	3.78 (96)	4.65 (118)	0.20 (5)	0.24 (6)	5.04 (128)	0.79 (20)	M4	3.53 (1.6)	53.7	19.1	72.8	2
	22P2	A011	3	4.25 (108)	5.83 (148)	5.51 (140)	3.78 (96)	4.65 (118)	0.20 (5)	0.24 (6)	5.04 (128)	0.79 (20)	M4	3.75 (1.7)	60.4	34.4	94.8	2
	23P7	A017	5	5.51 (140)	5.83 (148)	5.63 (143)	5.04 (128)	4.65 (118)	0.20 (5)	0.24 (6)	5.04 (128)	0.79 (20)	M4	5.30 (2.4)	96.7	52.4	149.1	2
460V 3-phase	40P2	B001	1/2	4.25 (108)	5.83 (148)	3.62 (92)	3.78 (96)	4.65 (118)	0.20 (5)	0.24 (6)	5.04 (128)	0.79 (20)	M4	2.65 (1.2)	9.4	13.7	23.1	2
	40P4	B002	3/4	4.25 (108)	5.83 (148)	4.43 (110)	3.78 (96)	4.65 (118)	0.20 (5)	0.24 (6)	5.04 (128)	0.79 (20)	M4	2.65 (1.2)	15.1	15.0	30.1	2
	40P7	B003	1 & 2	4.25 (108)	5.83 (148)	5.51 (140)	3.78 (96)	4.65 (118)	0.20 (5)	0.24 (6)	5.04 (128)	0.79 (20)	M4	3.75 (1.7)	30.3	24.6	54.9	2
	41P5	B005	3	4.25 (108)	5.83 (148)	6.14 (156)	3.78 (96)	4.65 (118)	0.20 (5)	0.24 (6)	5.04 (128)	0.79 (20)	M4	3.75 (1.7)	45.8	29.9	75.7	2
	42P2	-	3	4.25 (108)	5.83 (148)	6.14 (156)	3.78 (96)	4.65 (118)	0.20 (5)	0.24 (6)	5.04 (128)	0.79 (20)	M4	3.75 (1.7)	50.5	32.5	83.0	2
	43P7	B009	5	5.51 (140)	5.83 (148)	5.63 (143)	5.04 (128)	4.65 (118)	0.20 (5)	0.24 (6)	5.04 (128)	0.79 (20)	M4	5.30 (2.4)	73.4	44.5	117.9	2

(1) When drives include network communications option board, add 1.5" to drive depth.

Fig. 3

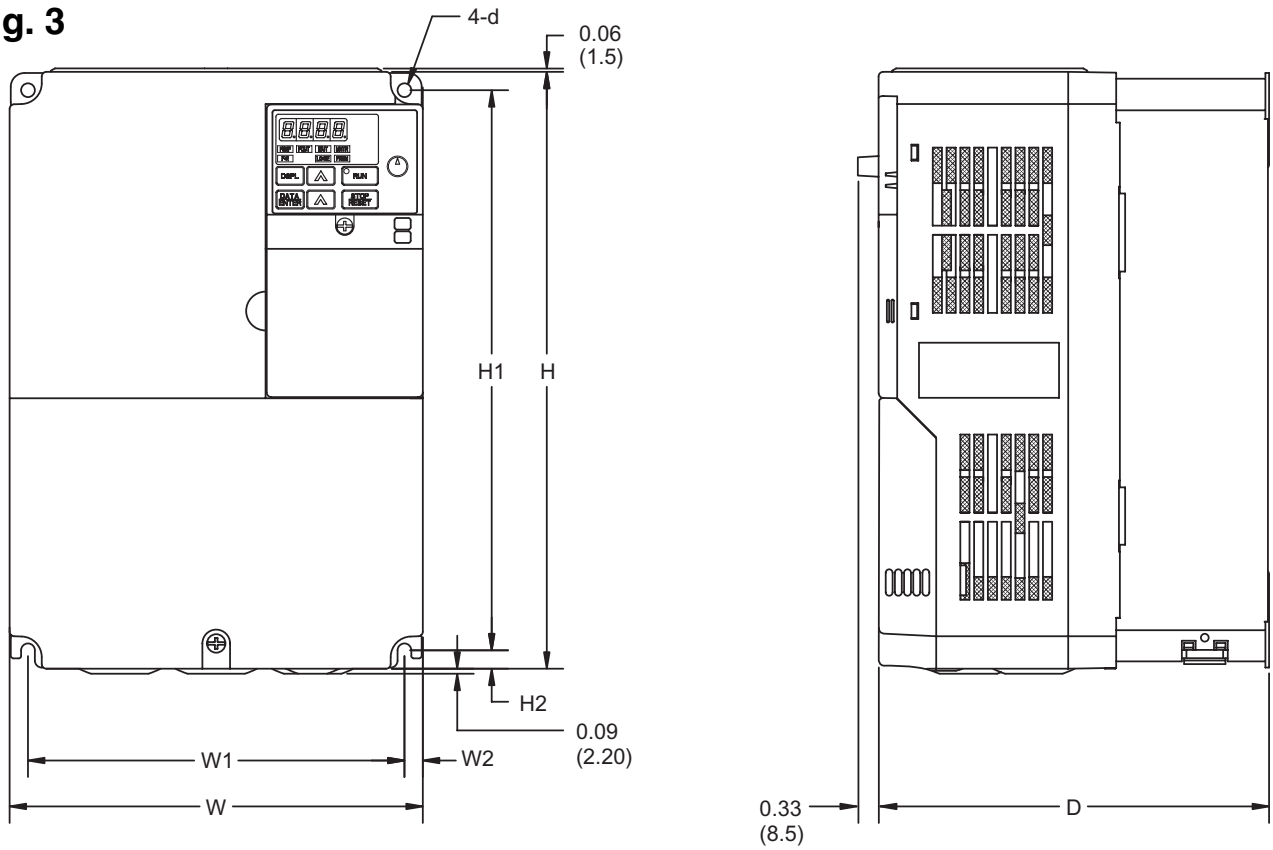

V7 Enclosed wall mounted type (NEMA type 1)

Voltage Class	Model		Size	Dimensions in inches (mm)										Weight Lbs. (kg)	Heat Loss (W)			Fig.
	CIMR-V7*	MV		HP	W	H	D	W1	H1	H2	W2	H3	H4		d	Heat-sink	Internal	
230V 3-phase	25P5	A025	7.5	7.09 (180)	10.24 (260)	6.70 (170)	6.46 (164)	9.61 (244)	0.31 (8)	0.31 (8)	-	-	M5	11.45 (5.2)	170.4	79.4	249.8	3
	27P5	A033	10	7.09 (180)	10.24 (260)	6.70 (170)	6.46 (164)	9.61 (244)	0.31 (8)	0.31 (8)	-	-	M5	11.89 (5.4)	219.2	98.9	318.1	3
460V 3-phase	45P5	B015	10	7.09 (180)	10.24 (260)	6.70 (170)	6.46 (164)	9.61 (244)	0.31 (8)	0.31 (8)	-	-	M5	10.14 (4.6)	168.8	87.7	256.5	3
	47P5	-	15 ⁽³⁾	7.09 (180)	10.24 (260)	6.70 (170)	6.46 (164)	9.61 (244)	0.31 (8)	0.31 (8)	-	-	M5	10.58 (4.8)	209.6	99.3	308.9	3

⁽¹⁾ When drives include network communications option board, add 1.5" to drive depth.

⁽²⁾ 230 and 460V drives represented in Figure 3 can be used as "IP00" type enclosures if the top and bottom covers are removed.

⁽³⁾ Horsepower rating of 15 only available as V74X drive.

Fig. 4

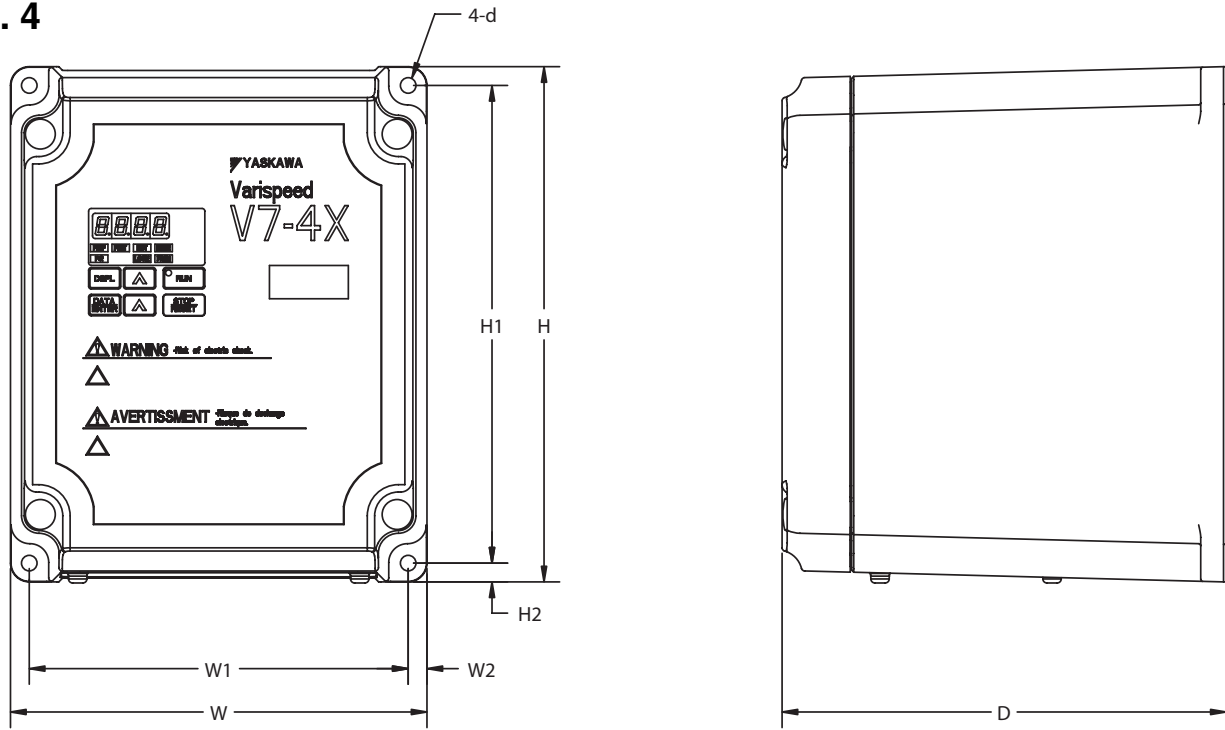

V74X Enclosed wall mounted type (NEMA 4)

Voltage Class	Model	Size	Dimensions in inches (mm)								Weight Lbs. (kg)	Fig.
	CIMR-V7CU <input type="checkbox"/>	HP	W	H	D	W1	H1	H2	W2	d		
230V 3-Phase	20P24	0.25	6.10 (155)	7.56 (192)	6.50 (165)	5.55 (141)	7.01 (178)	0.28 (7)	0.28 (7)	0.20 (5)	7.8 (3.52)	4
	20P44	0.5	6.10 (155)	7.56 (192)	6.50 (165)	5.55 (141)	7.01 (178)	0.28 (7)	0.28 (7)	0.20 (5)	8.0 (3.62)	4
	20P74	1	6.10 (155)	7.56 (192)	6.50 (165)	5.55 (141)	7.01 (178)	0.28 (7)	0.28 (7)	0.20 (5)	8.2 (3.72)	4
	21P54	2	6.69 (170)	10.0 (254)	7.48 (190)	6.22 (158)	9.41 (239)	0.24 (6)	0.24 (6)	0.20 (5)	13.0 (5.90)	4
	22P24	3	6.69 (170)	10.0 (254)	7.48 (190)	6.22 (158)	9.41 (239)	0.24 (6)	0.24 (6)	0.20 (5)	13.3 (6.00)	4
	23P74	5	6.69 (170)	10.0 (254)	7.48 (190)	6.22 (158)	9.41 (239)	0.24 (6)	0.24 (6)	0.20 (5)	13.7 (6.20)	4
	25P54	7.5	11.41 (290)	15.98 (406)	11.34 (288)	10.63 (270)	14.17 (360)	0.91 (23)	0.39 (10)	0.28 (7)	41.5 (18.6)	4
460V 3-Phase	27P54	10	11.41 (290)	15.98 (406)	11.34 (288)	10.63 (270)	14.17 (360)	0.91 (23)	0.39 (10)	0.28 (7)	41.5 (18.8)	4
	40P24	1/2	6.10 (155)	7.56 (192)	6.50 (165)	5.55 (141)	7.01 (178)	0.28 (7)	0.28 (7)	0.20 (5)	8.4 (3.82)	4
	40P44	3/4	6.10 (155)	7.56 (192)	6.50 (165)	5.55 (141)	7.01 (178)	0.28 (7)	0.28 (7)	0.20 (5)	8.4 (3.82)	4
	40P74	1 & 2	6.10 (155)	7.56 (192)	6.50 (165)	5.55 (141)	7.01 (178)	0.28 (7)	0.28 (7)	0.20 (5)	8.7 (3.92)	4
	41P54	3	6.69 (170)	10.0 (254)	7.48 (190)	6.22 (158)	9.41 (239)	0.24 (6)	0.24 (6)	0.20 (5)	13.3 (6.00)	4
	42P24	3	6.69 (170)	10.0 (254)	7.48 (190)	6.22 (158)	9.41 (239)	0.24 (6)	0.24 (6)	0.20 (5)	13.3 (6.00)	4
	43P74	5	6.69 (170)	10.0 (254)	7.48 (190)	6.22 (158)	9.41 (239)	0.24 (6)	0.24 (6)	0.20 (5)	13.7 (6.20)	4
45P54	7.5 & 10	11.41 (290)	15.74 (400)	11.42 (290)	10.63 (270)	14.17 (360)	0.79 (20)	0.39 (10)	0.28 (7)	41.5 (18.8)	4	
47P54	15 ⁽¹⁾	11.41 (290)	15.74 (400)	11.42 (290)	10.63 (270)	14.17 (360)	0.79 (20)	0.39 (10)	0.28 (7)	41.5 (18.8)	4	

When drives include network communications option board, add 2.0" to drive depth.

⁽¹⁾ Applicable to the V74X Model only.

Appendix 6. DYNAMIC BRAKING OPTION

GENERAL. Dynamic braking (DB) enables the motor to be brought to a smooth and rapid stop. This is achieved by dissipating the regenerative energy of the AC motor across the resistive components of the Dynamic Braking option. For further details on dynamic braking, see the option instruction sheet shipped with the dynamic braking components.

The Drive has an integral braking transistor. However, to make use of the Dynamic Braking function requires addition of either a Braking Resistor (for 3% duty cycle) or Braking Resistor Unit (for 10% duty cycle). See table below. In either case, interface to external control circuitry is necessary to ensure that dynamic brake resistor overheating is communicated to the drive as a fault condition.

Table A6-1. Drive DB Components

Model		Size	DB Components				Minimum Connect Resistance (SL)
CIMR-V7* <input type="checkbox"/>	MV <input type="checkbox"/>	HP	Braking Resistor - 3% Duty		Braking Resistor - 10% Duty		
			Part No.	Qty. Reqd.	Part No.	Qty Reqd.	
20P1	A001	1/8	50185531	1	—	—	300
20P2	A002	1/4	50185531	1	—	—	300
20P4	A003	1/2	50185430	1	05P00041-0825	1	200
20P7	A005	3/4&1	50185430	1	05P00041-0825	1	120
21P5	A008	2	50185431	1	05P00041-0827	1	60
22P2	A011	3	50185432	1	05P00041-0827	1	60
23P7	A017	5	50185433	1	05P00041-0828	1	32
25P5	A025	7.5	N/A	—	05P00041-0829	1	9.6
27P5	A033	10	N/A	—	05P00041-0830	1	9.6
40P2	B001	1/2	50185530	1	05P00041-0835	1	750
40P4	B002	3/4	50185530	1	05P00041-0835	1	750
40P7	B003	1&2	50185530	1	05P00041-0835	1	510
41P5	B005	3	50185531	1	05P00041-0837	1	240
42P2	—	3	50185531	1	05P00041-0837	1	240
43P7	B009	5	50185531	2	05P00041-0838	1	100
45P5	B015	7.5&10	N/A	—	05P00041-0840	1	32
47P5	—	15 ⁽¹⁾	N/A	—	05P00041-0841	1	32

⁽¹⁾ Applicable to the V74X model only

DYNAMIC BRAKING OPTION INSTALLATION. This option must be installed by a **TECHNICALLY QUALIFIED INDIVIDUAL** who is familiar with this type of equipment and the hazards involved.

 **WARNING**

**HAZARDOUS VOLTAGE CAN CAUSE SEVERE INJURY OR DEATH.
LOCK ALL POWER SOURCES FEEDING THE DRIVE IN “OFF” POSITION.**

 **CAUTION**

Failure to follow these installation steps may cause equipment damage or personnel injury.

Preliminary Procedures

1. Disconnect all electrical power to the drive.
2. Open the Drive's terminal covers.
3. Verify that voltage has been disconnected by using a voltmeter to check for voltage at the incoming power terminals, L1 (R), L2 (S) and L3 (T).

Braking Resistor (3% Duty Cycle) Installation

Note: The 3% duty cycle Braking Resistor is supplied with 6-inch leads.

1. Mount the Braking Resistor, along with an overload or thermostat, in a suitable metal enclosure.
2. At the Drive. Connect the leads from the Braking Resistor to drive terminals B1 and B2, and make connections to external control circuit, as shown in Figure A6-1.
3. Close the Drive's terminal covers.
4. Proceed to “Adjustments” on page A6-4.

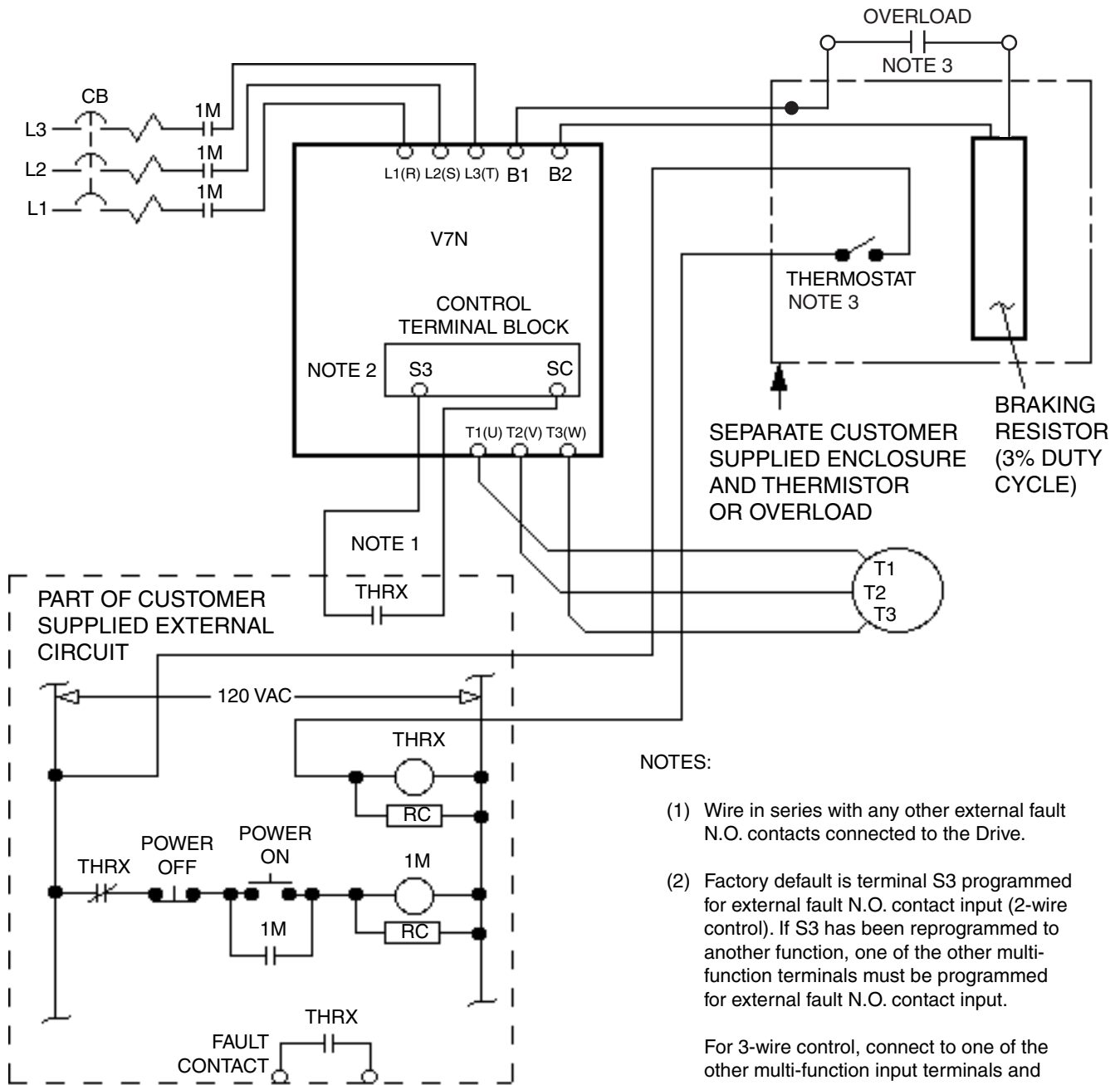

NOTES:

- (1) Wire in series with any other external fault N.O. contacts connected to the Drive.
- (2) Factory default is terminal S3 programmed for external fault N.O. contact input (2-wire control). If S3 has been reprogrammed to another function, one of the other multi-function terminals must be programmed for external fault N.O. contact input.

For 3-wire control, connect to one of the other multi-function input terminals and program that terminal for external fault N.O. contact input.
- (3) Either an overload can be used in series with the Braking resistor or a thermostat can be configured as shown.

Figure A6-1. Typical Wiring of Braking Resistor (for 3% Duty Cycle) to Drive

Braking Resistor (10% Duty Cycle) Installation

IMPORTANT

Since the Braking Resistor Unit generates heat during the dynamic braking operation, install it in a location away from other equipment which emits heat.

1. Mount the Braking Resistor Unit on a vertical surface, maintaining minimum 1.18 inch (30 mm) clearance on each side and 5.91 inch (150 mm) clearance top and bottom.
2. Open the Braking Resistor Unit terminal box to access its terminal block. Connect the Braking Resistor Unit to the drive and external control circuit according to the following table and Figure A6-2.

Terminals	B, P, B1, B2	1, 2, S3, SC*
Lead Size (AWG)	12 - 10	18 - 14 *
Lead Type	600V ethylene propylene rubber insulated, or equivalent	
Terminal Screw	M4 (resistor end)	

* Power leads for the Braking Resistor Unit generate high levels of electrical noise; therefore, signal leads must be grouped separately.

3. Close and secure the cover of the Braking Resistor Unit terminal box. Close the Drive's terminal covers.
4. **Adjustments.** Program constant *n092* to " 1 "; this disables stall prevention during deceleration.

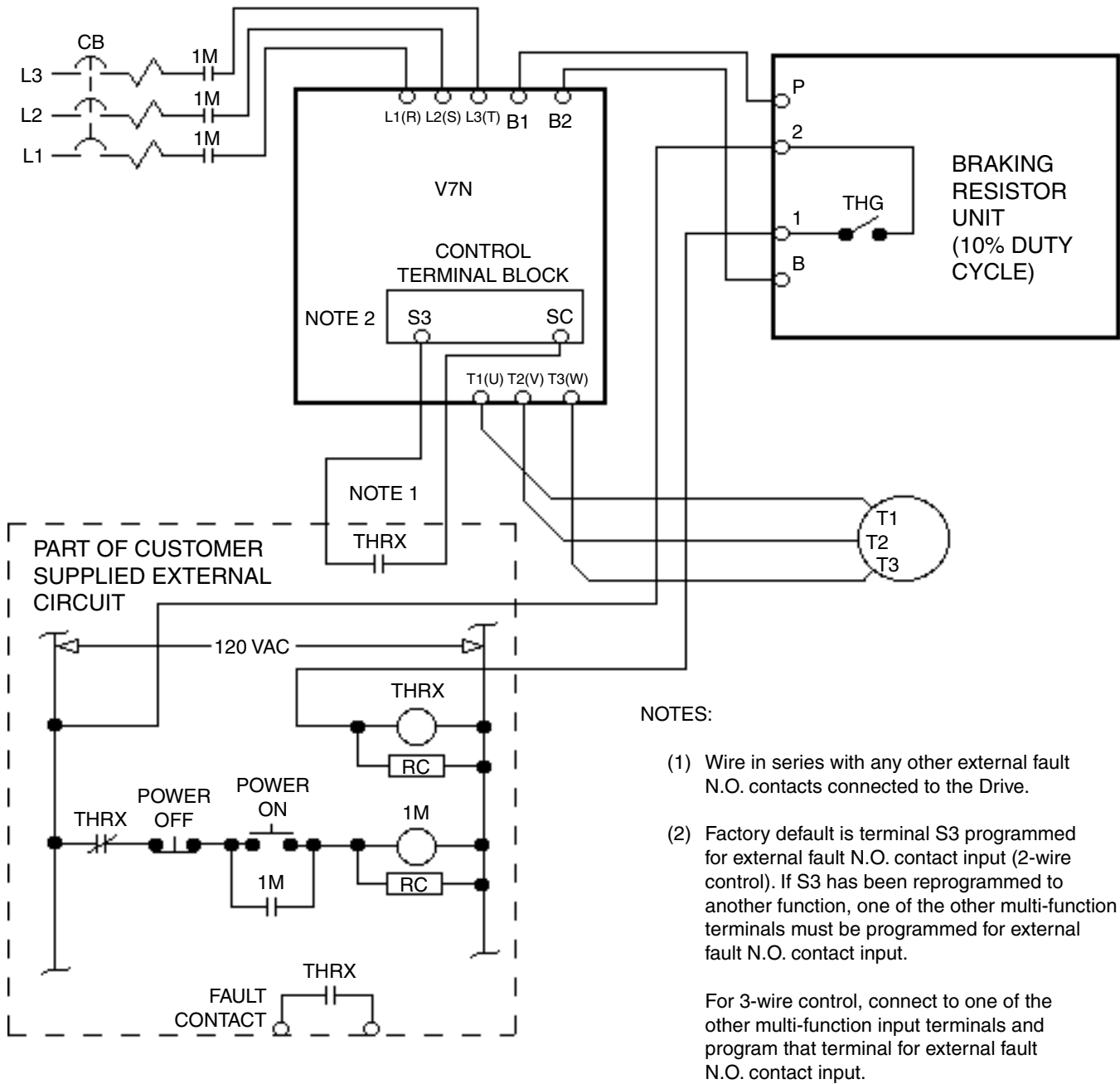
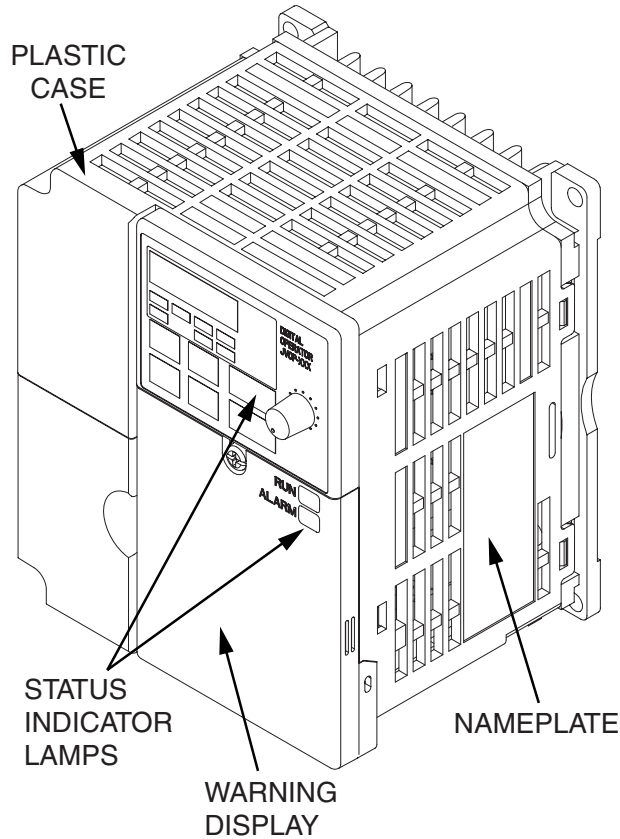
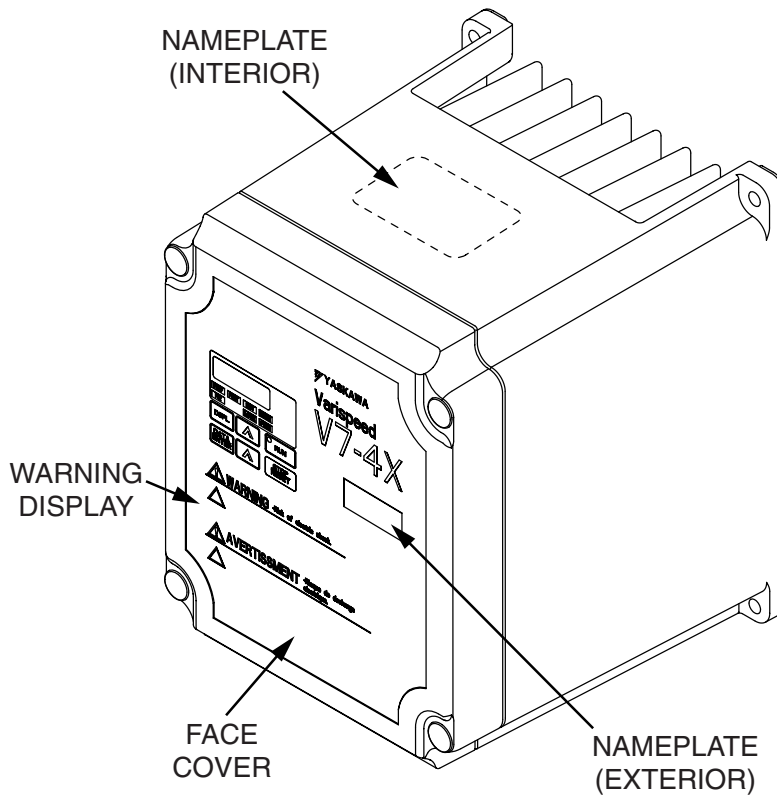

Figure A6-2. Typical Wiring of Braking Resistor Unit (for 10% Duty Cycle) to Drive

Appendix 7. NAMEPLATE INFORMATION



V7 [NEMA type 1]



V74X [NEMA type 4X/12]

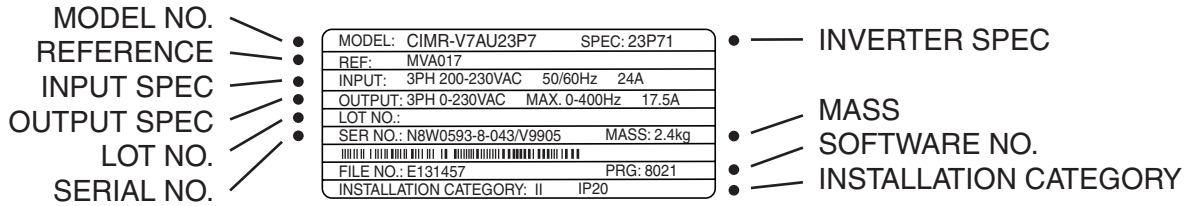

V7 [NEMA type 1]

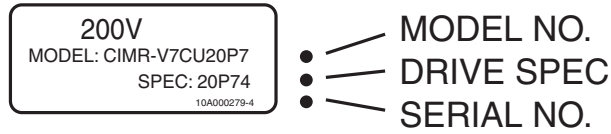
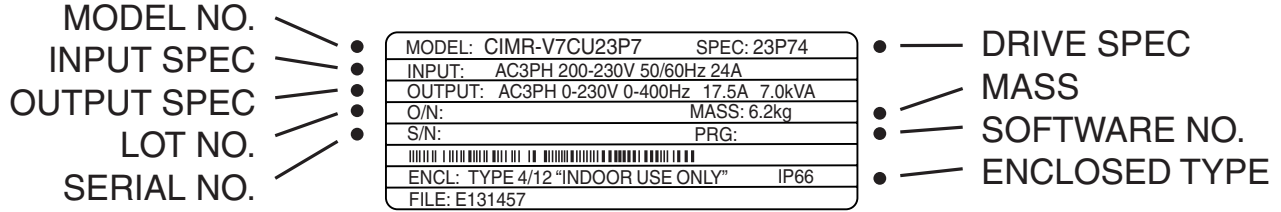

V74X [NEMA type 4X/12]

Model Number Structure

C I M R - V 7 A M 2 3 P 7

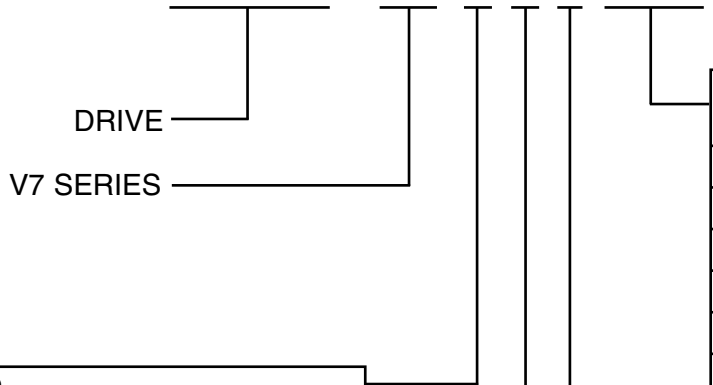

No.	Type
A	With digital operator
B	Without digital operator
C	With digital operator
R	Finless

Note: Contact your YASKAWA representative for finless type drives.

No.	Applicable max. motor output (HP)	
	230V	460V
0P1	1/8	—
0P2	1/4	1/2
0P4	1/2	3/4
0P7	3/4 & 1	1 & 2
1P5	2	3
2P2	3	3
3P7	5	5
5P5	7.5	7.5 & 10
7P5	10	15 ⁽¹⁾

No.	Voltage Class	
B	Single-phase	230VAC
2	Three-phase	230VAC
4	Three-phase	460VAC

No.	Specifications
U or M	UL Specification (U.S.) Specification)

⁽¹⁾ Applies to NEMA type 4x/12 model only

Ref Model Number Structure (applicable to V7/NEMA type 1 only)

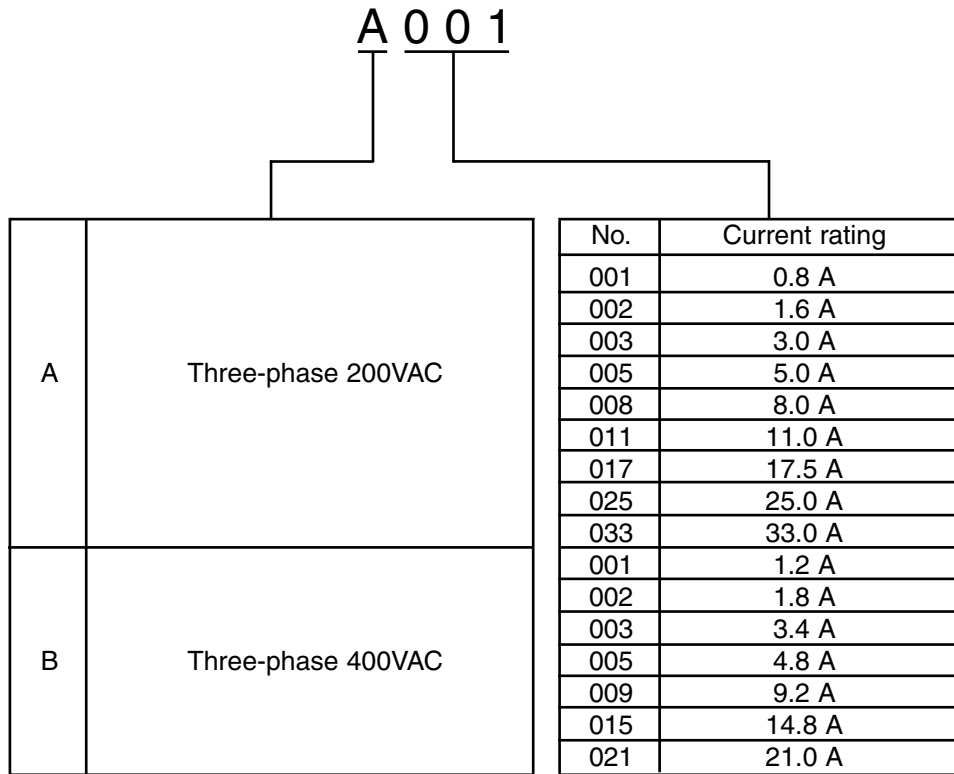

Drive Spec Structure

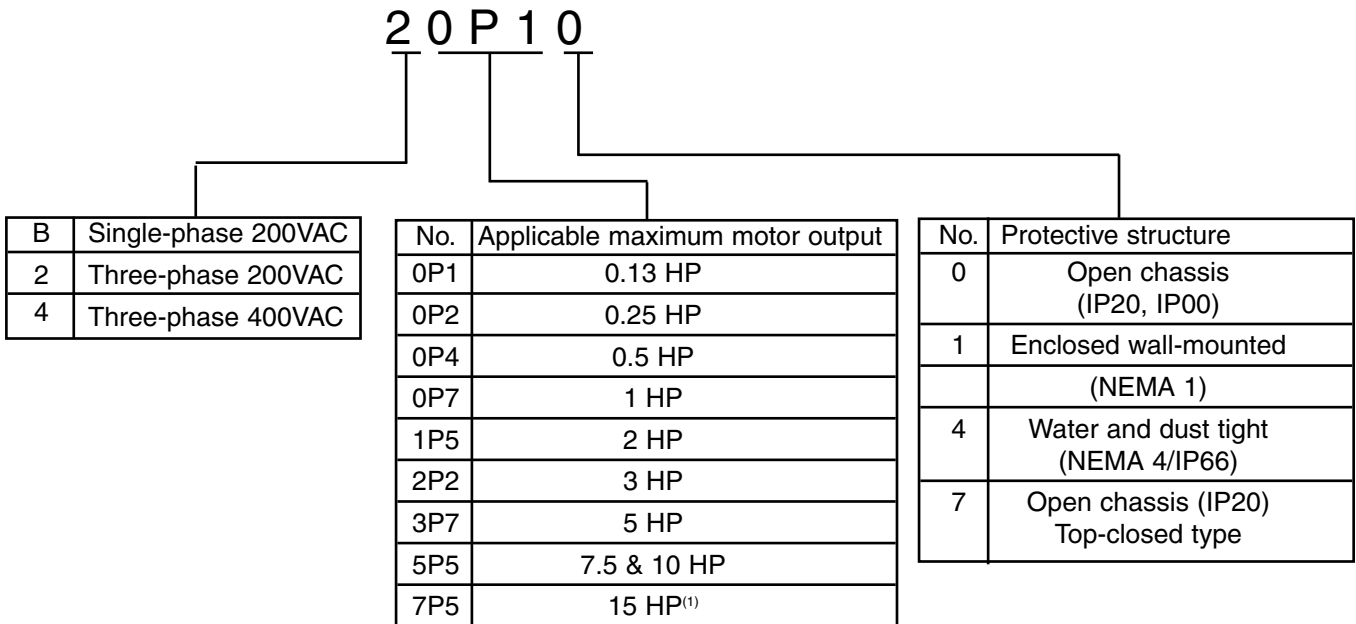

Note: Model Number and Drive Spec Number are required to fully define a drive.

⁽¹⁾ Applies to NEMA type 4x/12 model only

Appendix 8. REMOVE/INSTALL DRIVE FACE PLATES

REMOVING AND MOUNTING DIGITAL OPERATOR COVERS

NOTE: Mount the Drive after removing the front cover, digital operator and terminal cover.

- **Removing front cover**

Use a screwdriver to loosen the screw on the front cover surface to direction 1 to remove it. Then press the right and left sides to direction 2 and lift the front cover to direction 3.

- **Mounting front cover**

Mount the front cover in the reverse order of the above procedure for removal.

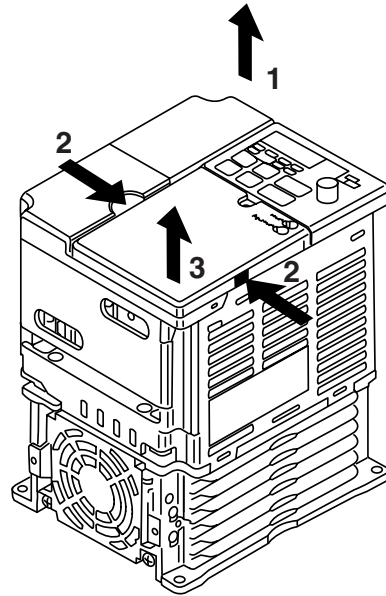

- **Removing terminal cover when “W” (Width) dimensions are 4.25" (108mm), 5.51" (140mm), or 6.69" (170mm)**

After removing the front cover, press the right and left sides to direction 1 and lift the terminal cover to direction 2.

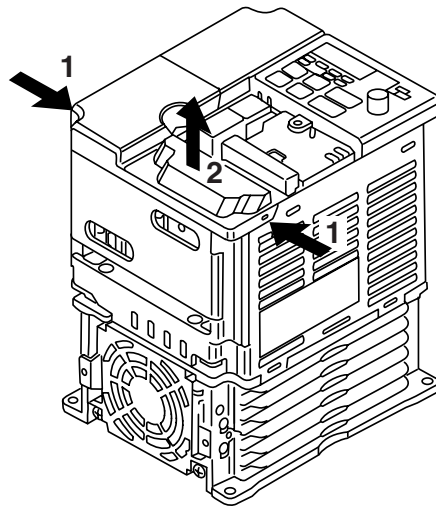

- **Removing terminal cover when “W” (Width) dimensions are 7.09" (180mm)**

Use a screwdriver to loosen the screw on the terminal cover surface to direction 1 to remove it. Then press the right and left sides to direction 2 and lift the terminal cover to direction 3.

- **Mounting terminal cover**

Mount the terminal cover in the descending order of the above procedure for removal.

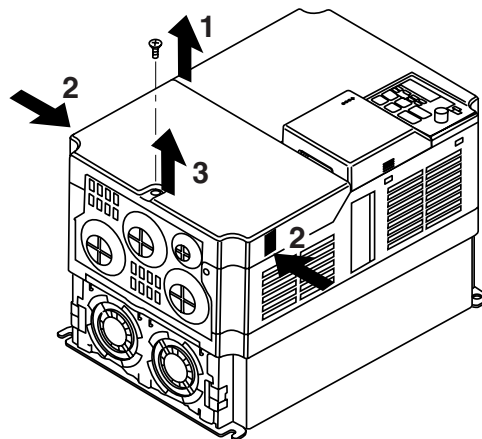

- **Removing digital operator**
After removing the front cover, lift the upper and lower sides (section A) of the right side of the digital operator to direction 1.

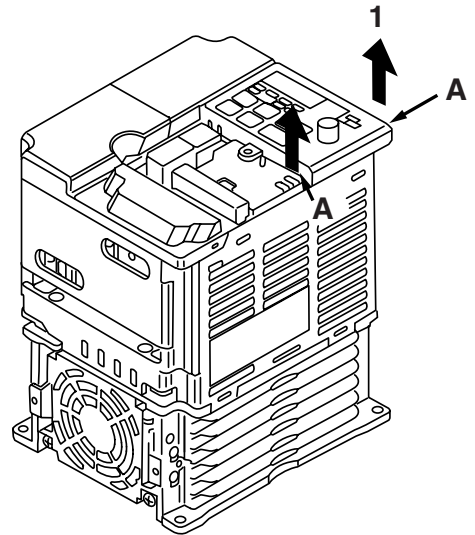

- **Mounting digital operator**
Mount the digital operator in the reverse order of the above procedure for removal.

- **Removing bottom cover when “W” (Width) dimensions are 4.25" (108mm), 5.51" (140mm), or 6.69" (170mm)**
After removing the front cover and the terminal cover, tilt the bottom cover to direction 1 with section A as a supporting point.

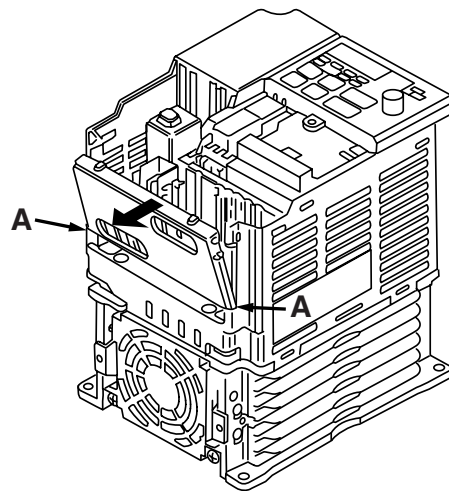

- **Removing terminal cover when “W” (Width) dimensions are 7.09" (180mm)**
After removing the terminal cover use a screwdriver to loosen the fastening screw to direction 1 to remove it.

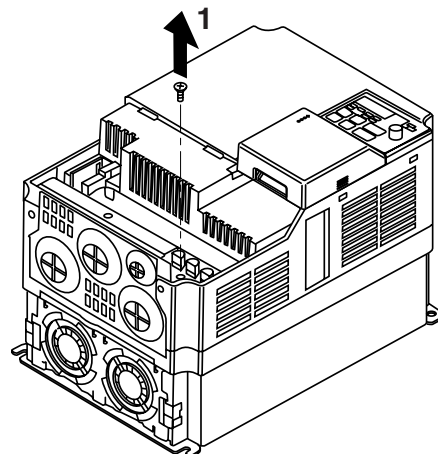

- **Mounting bottom cover**
Mount the bottom cover in the reverse order of the above procedure for removal.

Removing the front cover and the bottom cover of V74X [NEMA type 4X/12] Models 20P1-22P7 & 40P2-43P7

IMPORTANT

Damage to the drive can occur if the front cover is removed too quickly.

Front Cover:

Remove the four mounting bolts and *slowly* take off the cover. Disconnect the cable between the face cover and the control board located in the lower portion of the Drive. For mounting, reverse the direction.

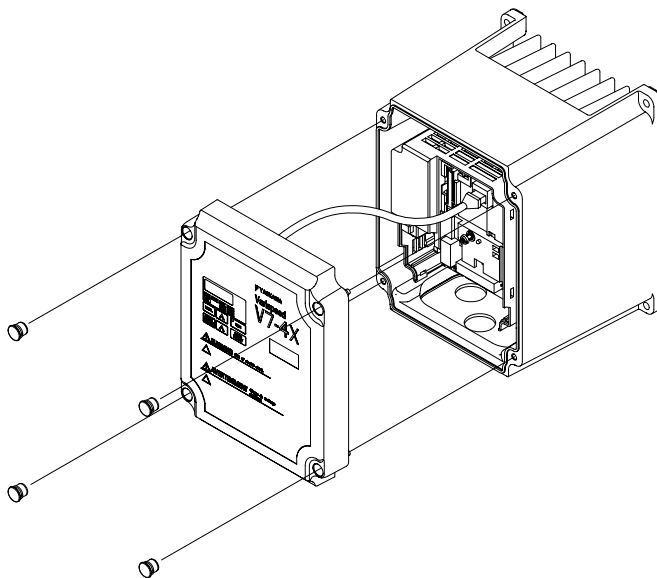

Bottom Cover:

Remove the four mounting bolts when installing cable glands, etc. Install wiring after inserting cables through the cable glands and securing them to the bottom cover. See section 1-4 on recommended cable gland sizes. Conduit plate gasket may be attached to the Drive and may not be removable in some cases.

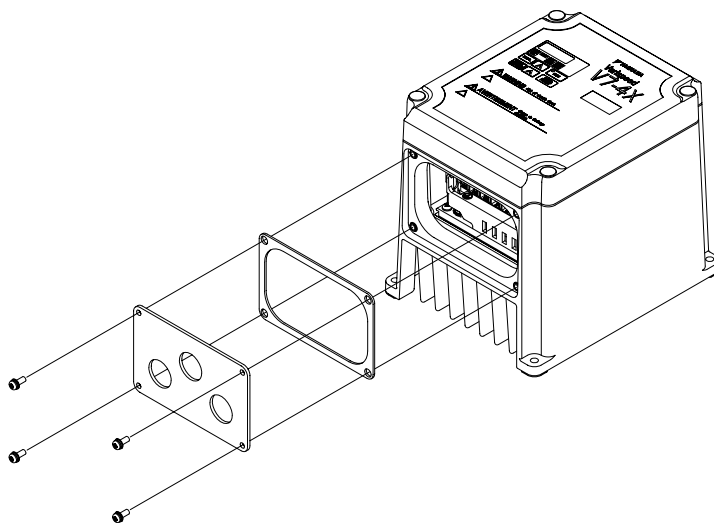

To remove the front cover of V74X [NEMA type 4X/12], models 25P5, 27P5, 45P5 and 47P5:
Remove the six mounting bolts from the front of the enclosure, then carefully remove front cover.

INDEX

- A -

Acceleration :	
Accel time 1	5-2
Accel time 2	5-2
Hold	5-27
S-curve	5-3
Time setting unit	5-2
Analog monitor outputs,	
multi-function	5-20
Analog inputs,	
multi-function selection	5-55
Auto restart	5-4

- B -

Braking :	
DC injection	5-7
Dynamic	A6-1

- C -

Carrier frequency	5-5
Conformance to European	
EMC Directive	1-8
Contactors — <i>see</i>	
<i>Peripheral Devices</i>	
Control circuit :	
Terminals	1-6
Wiring	1-5
Copy function	5-46
Critical frequency	
rejection	5-6
Current :	
Limit — <i>see Stall Prevention</i>	
Motor	2-3, 2-7
Output (IOUT)	4-2
Output (monitor)	4-4

- D -

DATA/ENTER key	4-1
DC injection :	
Time at start	5-7
Time at stop	5-7
Deadband, prohibited	
frequency	5-6
Deceleration :	
Decel time 1	5-2
Decel time 2	5-2
S-curve	5-3

Time setting unit	5-2
Decrease () key	4-1
Diagnostics — <i>see</i>	
<i>Troubleshooting</i>	
Digital operator	4-1
Dimensions	A5-1, A5-2
Display Selection	5-52
DSPL key	4-1
Dynamic braking option	A6-1

- E -

EMC Directive, European,	
Conformance to	1-9
Enclosure	A2-2
Energy Saving	5-53
Environment	1-1, A2-2
External base block	5-24

- F -

F/R LED	4-2
Fault displays	6-1
Fault history	6-8
Faults :	
Restart attempts	5-4
FOUT LED	4-2
FREF LED	4-2
Frequency :	
Detection	5-31
Max. output	A2-1
Output (FOUT)	4-2
Output (monitor)	4-4
Frequency reference :	
Bias (analog)	5-8
Gain (analog)	5-8
Jog	5-13
Limits	5-9
Loss detection	5-57
Retention (Up/Down)	5-9
Selection	5-10
V/f parameters	5-41
Fusing, Recommended	A4-2

- G -

Gain :	
Analog monitor	5-20
Frequency reference (analog)	5-8
Torque compensation	5-39
Grounding	1-5

- H -

Heat loss (watts) A5-1, A5-2
Hold :
 Accel/decel 5-23, 5-27
 Frequency ref. (retention) 5-9

- I -

Increase () key 4-1
Initialize parameters 5-33
Inputs, multi-function 5-21
Inspection (receiving) 1-1
Installation:
 Electrical 1-4
 Physical 1-1
IO/OUT LED 4-2

- J -

Jog reference 5-13

- K -

Keypad — *see Digital Operator*

- L -

LEDs :
 Function 4-2
 Status Indicator 4-3
Local/Remote reference and
 sequence selection 5-14
LO/RE LED 4-2

- M -

Main circuit :
 Terminals 1-4
 Wiring 1-4
Mechanical resonance —
 see Critical Frequency Rejection
MNTR LED 4-2
MODBUS control 5-16
Model Number, GPD 315 A2-1
Momentary power loss ride-through 5-20
Monitor displays 4-3
Motor :
 No-load current 2-4, 2-5, 5-34
 Protection 5-38
 Rated current 2-4, 2-5, 5-34
 Rated slip 2-3
 Switching — *see Speed Search*
 Wiring 1-4

Mounting :

 Clearances 1-1
 Dimensions A5-1, A5-2
 European EMC
 conformance 1-8
 Location 1-1, A2-2
Multi-function analog
 input selection 5-55
Multi-function analog
 monitor output 5-20, 5-21
Multi-function input
 terminals 5-22 - 5-27
Multi-function output
 terminals 5-28
Multi-step speeds 5-10

- N -

Nameplate, motor 2-2, 2-3, 2-7

- O -

Open loop vector startup 2-2
Operation at load 3-1
Operation mode 5-14
Operator display 4-1
Options — *see Peripheral
 Devices or Dynamic Braking*
Outputs :
 Analog 5-20
 Contact 5-28
 Multi-function 5-28
 Open collector 5-28
Overtorque detection 5-31

- P -

Parameters :

 Capacity and control
 method related A3-1
 Listing of A1-1
 Reset (initialize) 5-33
Peripheral devices :
 AC and DC reactor A4-1
 Ground fault interrupter A4-1
 Magnetic contactor A4-1
 Molded-case circuit
 breaker (MCCB) A4-1
 Noise filter 1-8, A4-1
PID Control 5-42
Potentiometer 4-1
Power loss ride-through 5-20
Power supply A2-1
Pre-power checks 2-1

Preset speeds — <i>see</i> <i>Multi-step speeds</i>	
PRGM LED	4-2
Prohibited frequency deadband	5-6
Protection :	
Overcurrent	5-35
Overheat (drive)	A2-1
Overtorque	5-31
Overvoltage (decel)	5-35
Thermal overload (mtr)	5-38
Undervoltage	A2-2
Protective functions, miscellaneous	5-20

- R -

Rated current, motor	2-3, 2-7, 5-38
Ratings	i, A2-1
Receiving	1-1
Remote reference — <i>see</i> <i>Local/Remote</i>	
Reset codes	5-33
Reverse prohibit	1-10, 1-12
Ride-through	5-20
RUN key	4-1

- S -

S-curve	5-3
Shock resistance — <i>see</i> <i>S-curve</i>	
Slip compensation	5-34
Soft start — <i>see</i> <i>S-curve</i>	
Specifications	A2-1
Speed :	
Coincidence	5-30
Search	5-23
Stall prevention :	
Accel	5-35
Decel	5-35
During running	5-36
Start-up:	
Open loop vector	2-2
V/f control	2-6
STOP/RESET key	4-1, 5-14
Stopping method selection	5-37
Switches, internal :	
SW1	5-22
SW2	5-10, 5-16
Switching frequency — <i>see</i> <i>Carrier frequency</i>	

- T -

Temperature :	
Ambient	A2-2
Storage	A2-2
Terminals :	
Functions	1-4, 1-6
Screw sizes	1-3
Thermal overload protection	5-38
Torque boost (open loop vector)	5-39
Torque compensation gain (V/F control)	5-39
Torque detection	5-31
Troubleshooting	6-1

- U -

Up/down function	5-26
Undertorque detection	5-58

- V -

V/f pattern	5-40
V/f startup procedure	2-6
Voltage :	
DC bus (monitor)	4-4
DC bus (stall prev.)	5-35
Max. output	A2-1
Output (monitor)	4-4
V/f parameters	5-41

- W -

Weight	A5-1, A5-2
Wiring :	
2-Wire control	1-4
3-Wire control	1-4
Auxiliary input and output power option devices	1-7
Conduit	1-7
Control circuit	1-5
Diagrams	1-11, 1-13
Distances	1-4, 1-5, 1-8, A2-2
Main circuit	1-4

Drives Technical Support in USA and Canada

Technical Support for Inverters and Drives is available by phone as follows:

Normal: Monday through Friday during the hours of 8 a.m. to 5:00 p.m. C.S.T.

Emergency: After normal hours, 7 days a week including weekends and holidays

To contact Drives Technical Support, please call 1-800-YASKAWA (927-5292).

From the menu, dial 2 for Inverter and Drive Products, then 5 for Technical Support.

Drives Technical Support can also be reached by e-mail at DriveSupport@yaskawa.com.

Support information, such as technical manuals, FAQs, instruction sheets and software downloads are available at our website, www.drives.com.

When calling for technical support, please have the following materials available:

- The appropriate Technical Manual in hand because the support associate may refer to this

- Complete nameplate information from the drive and the motor.

- (Confirm that Drive Nameplate Output amps is greater than Motor Nameplate amps)

 - list with your parameter settings

- A sketch of the electrical powertrain, from AC line to motor, including filters and disconnects

Field Service, Start Up Assistance, Factory Repair, Replacement Parts, and Other Support

Contact Drives Technical Support for help with any of these needs.

Technical Training

Training is conducted at Yaskawa training centers, at customer sites, and via the internet.

For information, visit www.drives.com or call 1-800-YASKAWA (927-5292).

From the phone menu, dial 2 for Inverter and Drive Products, then 4 for Product Training.

Support in Other Countries

Yaskawa is a multi-national company with offices and service representation around the world.

To obtain support, always contact the local distributor first for guidance and assistance.

Contact the closest Yaskawa office listed for further assistance.

V7 and V74X Drives



YASKAWA ELECTRIC AMERICA, INC.

Drives Division
16555 W. Ryerson Rd., New Berlin, WI 53151, U.S.A.
Phone: (800) YASKAWA (800-927-5292) Fax: (262) 782-3418
Internet: <http://www.drives.com>

YASKAWA ELECTRIC AMERICA, INC.

Chicago-Corporate Headquarters
2121 Norman Drive South, Waukegan, IL 60085, U.S.A.
Phone: (800) YASKAWA (800-927-5292) Fax: (847) 887-7310
Internet: <http://www.yaskawa.com>

MOTOMAN INC.

805 Liberty Lane, West Carrollton, OH 45449, U.S.A.
Phone: (937) 847-6200 Fax: (937) 847-6277
Internet: <http://www.motoman.com>

YASKAWA ELECTRIC CORPORATION

New Pier Takeshiba South Tower, 1-16-1, Kaigan, Minatoku, Tokyo, 105-0022, Japan
Phone: 81-3-5402-4511 Fax: 81-3-5402-4580
Internet: <http://www.yaskawa.co.jp>

YASKAWA ELETRICO DO BRASIL COMERCIO LTDA.

Avenida Fagundes Filho, 620 Bairro Saude Sao Paulo-SP, Brasil CEP: 04304-000
Phone: 55-11-5071-2552 Fax: 55-11-5581-8795
Internet: <http://www.yaskawa.com.br>

YASKAWA ELECTRIC EUROPE GmbH

Am Kronberger Hang 2, 65824 Schwalbach, Germany
Phone: 49-6196-569-300 Fax: 49-6196-888-301

MOTOMAN ROBOTICS AB

Box 504 S38525, Torsas, Sweden
Phone: 46-486-48800 Fax: 46-486-41410

MOTOMAN ROBOTEC GmbH

Kammerfeldstrabe 1, 85391 Allershausen, Germany
Phone: 49-8166-900 Fax: 49-8166-9039

YASKAWA ELECTRIC UK LTD.

1 Hunt Hill Orchardton Woods Cumbernauld, G68 9LF, Scotland, United Kingdom
Phone: 44-12-3673-5000 Fax: 44-12-3645-8182

YASKAWA ELECTRIC KOREA CORPORATION

Paik Nam Bldg. 901 188-3, 1-Ga Euljiro, Joong-Gu, Seoul, Korea
Phone: 82-2-776-7844 Fax: 82-2-753-2639

YASKAWA ELECTRIC (SINGAPORE) PTE. LTD.

Head Office: 151 Lorong Chuan, #04-01, New Tech Park Singapore 556741, SINGAPORE
Phone: 65-282-3003 Fax: 65-289-3003

TAIPEI OFFICE (AND YATEC ENGINEERING CORPORATION)

10F 146 Sung Chiang Road, Taipei, Taiwan
Phone: 886-2-2563-0010 Fax: 886-2-2567-4677

YASKAWA JASON (HK) COMPANY LIMITED

Rm. 2909-10, Hong Kong Plaza, 186-191 Connaught Road West, Hong Kong
Phone: 852-2803-2385 Fax: 852-2547-5773

BEIJING OFFICE

Room No. 301 Office Building of Beijing International Club,
21 Jianguomanwai Avenue, Beijing 100020, China
Phone: 86-10-6532-1850 Fax: 86-10-6532-1851

SHANGHAI OFFICE

27 Hui He Road Shanghai 200437 China
Phone: 86-21-6553-6600 Fax: 86-21-6531-4242

SHANGHAI YASKAWA-TONJI M & E CO., LTD.

27 Hui He Road Shanghai 200437 China
Phone: 86-21-6533-2828 Fax: 86-21-6553-6677

BEIJING YASKAWA BEIKE AUTOMATION ENGINEERING CO., LTD.

30 Xue Yuan Road, Haidian, Beijing 100083 China
Phone: 86-10-6232-9943 Fax: 86-10-6234-5002

SHOUGANG MOTOMAN ROBOT CO., LTD.

7, Yongchang-North Street, Beijing Economic & Technological Development Area,
Beijing 100076 China
Phone: 86-10-6788-0551 Fax: 86-10-6788-2878

YEA, TAICHUNG OFFICE IN TAIWAN

B1, 6F, No.51, Section 2, Kung-Yi Road, Taichung City, Taiwan, R.O.C.
Phone: 886-4-2320-2227 Fax: 886-4-2320-2239