

Preface

Thank you for purchasing VD120 Series Inverters!

Unpacking and Inspection:

Every inverter has been inspected rigorously before shipping.

Please confirm carefully when unpacking the packing carton:

- Check if any damage signs of the product and its package.
- Check if the model and inverter rated values on the nameplate are the same as stated on your order and user manual.
- The box contains the inverter, manufacturer certificate, user manual.

If the product is damaged during transportation, or there is any omission or damage, please contact our company or your local supplier immediately.

Contents

Chapter 1 Safety and Precautions	- 1 -
1.1 Safety Precautions	- 1 -
Chapter 2 Product Information	- 3 -
2.1 Designation Rules	- 3 -
2.2 Nameplate	- 3 -
2.3 Inverter Series	- 3 -
2.4 Product Appearances and Installation Dimension	- 4 -
2.5 Recommended Brake Resistor Selection Table	- 7 -
2.6 Warranty Introduction	- 7 -
Chapter 3 Mechanical and Electrical Installation	- 8 -
3.1 Standard Wiring Diagram	- 8 -
3.2 Main Circuit Terminals	- 8 -
3.3 Control Circuit Terminal	- 9 -
Chapter 4 Operation and Display	- 12 -
4.1 Introduction to Operation and Display Interface	- 12 -
Chapter 5 Function Parameter Table	- 14 -
Chapter 6 Parameter Description	- 64 -
F0 Basic Function	- 64 -
F1 Start/Stop Control Group	- 71 -
F2 Motor 1 Parameter	- 77 -
F3 Motor 1 Vector Control Parameter	- 79 -
F4 Motor 1 V/F Control Parameter	- 82 -
F5 Input Terminal Group	- 86 -
F6 Output Terminal Function Group	- 98 -
F7 Keyboard and Display Function Group	- 103 -
F8 Protection Parameters	- 107 -
F9 Fault Record and Setting Parameter Group	- 110 -
FA Process PID Parameter Group	- 114 -
Fb Enhance Function Group	- 118 -
Fd MODBUS Communication Parameter Group	- 132 -
FF User Parameters Group	- 133 -
FP Factory Parameter Group	- 135 -
A0 Motor 1 Torque Control Parameter Group	- 135 -
A1 Optimize Control Parameter Group	- 138 -
b0 User Customize Function Code	- 141 -
b1 Virtual IO Parameter Group	- 142 -
b2 AI Curve Setting Parameter Group	- 146 -
b3 AIAO Correction Parameter Group	- 148 -
U0 Basic Monitoring Parameters Group	- 149 -
Chapter 7 EMC Guide	- 151 -
7.1 Definition	- 151 -
7.2 EMC Standard Introduction	- 151 -
7.3 EMC Guide	- 151 -
Chapter 8 Fault Shooting and Solutions	- 153 -
8.1 Fault Alarm and Countermeasures	- 153 -
8.2 Common Faults and Solutions	- 157 -

Chapter 9 Communication Protocol	- 158 -
9.1 About Protocol	- 158 -
9.2 Application Methods.....	- 158 -
9.3 Bus Structure	- 158 -
9.4 Protocol Description.....	- 158 -
9.5 Communication Frame Structure	- 158 -
9.6 Command Code and Communication Data Description	- 159 -
Fd MODBUS Communication	- 167 -

Chapter 1 Safety and Precautions

1.1 Safety Precautions

1.1.1 At Wiring

 **DANGER**

- Wiring must be performed only by qualified personnel under instructions described in this manual. Failure to comply may result in unexpected accidents.
- A circuit breaker must be used to isolate the power supply and inverter. Failure to comply may result in a fire.
- Ensure that the power supply is cut off before wiring. Failure to comply may result in electric shock.
- Connect inverter to ground properly by standard. Failure to comply may result in electric shock.
- Do not connect the input power with output terminals U, V, W, confirm the mark on terminal before connection to avoid wrong wiring. Failure to comply can damage the inverter!
- Never connect the braking resistor between the DC bus terminals P+ and P-. Failure to comply may result in a fire.
- The wire size of main circuit should conformed to standard, the wiring should comply with EMC and local safety standard. Failure to comply may result in accidents.
- Use shielded cable for input output control circuit of analog and rapid speed pulse signal, and ensure the shielding layer is reliably grounded.

1.1.2 Before Power-on:

 **DANGER**

- Check that the following requirements are met:
- The voltage class of the power supply is consistent with the rated voltage class of the AC drive.
- The input terminals (R, S, T) and output terminals (U, V, W) are properly connected.
- No short-circuit exists in the peripheral circuit.
- The wiring is secured.
- The external units of inverter and wires are configured under the manual instructed, all matched circuit and wiring are correctly connected.
- Failure to comply will result in damage to inverter!

1.1.3 After Power-on

 **DANGER**

- Do not open the cover after inverter power-on to prevent electric shock.
- Do not touch or operate the inverter with wet hands. Failure to comply will result in electric shock.
- Do not touch any terminal of inverter after power-on, or drag connection cable. Failure to comply will result in equipment damage or electric shock.
- Do not try to check or change the manufacturer parameter. Failure to comply may result in malfunction or damage to inverter!
- Make sure the mechanical equipment is ready to start before inverter run with loading, make sure related staff is in safety zone. Failure to comply will result in damage or personal hurt!
- Please pay attention to hiding accident which may result in personal hurt or property damage while motor is run, if it is necessary to identify the motor parameter.

1.1.4 During Operation

 **DANGER**

- Do not touch the cooling fan or braking resistor etc, otherwise may cause personal injury!
- Do not do inspection while inverter run, except for professional technician, otherwise may cause inverter damaged or personal injury.

 **WARNING**

- Do not move inverter or the installed cabinet while it is run, keep external objects falling into the device. Failure to comply will result in damage.
- Start/Stop inverter via terminal function or other control method, try not to start inverter via directly power-on control method. Do not use contactor on inverter output terminal to control motor starting or stop.

1.1.5 During Maintenance

 **DANGER**

- Do not repair and maintain the equipment if power is connected. Otherwise there will be danger of electric shock!
- If the LED is still on light on control panel, it is Disabled to disassemble the body in order to avoid electric shock.
- The inverter shall be repaired and maintained only by the qualified person who has received professional training. Otherwise, it may cause personal injury or equipment damage.
- For all the standard equipped or optional accessories, must be dismounted or mounted while the inverter power is disconnected.

Chapter 2 Product Information

2.1 Designation Rules

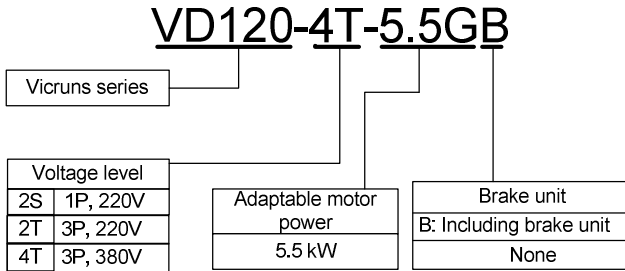

Fig 2.1-1 Designation Rules

2.2 Nameplate

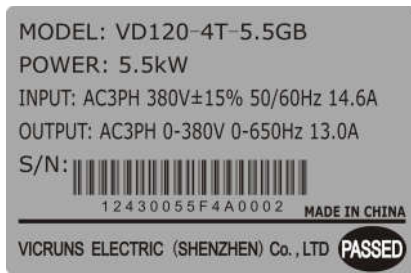

Fig 2.2-1 Nameplate

⚠ WARNING

- The bar code on inverter nameplate is the only code to recognize its identity, so the bar code is the most important basis for the after sales service.

2.3 Inverter Series

Table 2-1 Product specifications and technical data

Model No.	Power Capacity (KVA)	Rated Input Current (A)	Rated Output Current (A)	Adaptable Motor	
				(KW)	(HP)
Single-phase power supply: 220V,50/60Hz Range:-15%~20%					
VD120-2S-0.4GB	1.0	5.4	2.3	0.4	0.5
VD120-2S-0.7GB	2.0	9.8	4.8	0.7	1
VD120-2S-1.5GB	3.0	14.0	7.0	1.5	2
VD120-2S-2.2GB	4.0	23.0	9.6	2.2	3

Model No.	Power Capacity (KVA)	Rated Input Current (A)	Rated Output Current (A)	Adaptable Motor	
				(KW)	(HP)
Three-phase power supply: 220V,50/60Hz Range: -15%~20%					
VD120-2T-0.4GB	1.5	4.0	2.3	0.4	0.5
VD120-2T-0.7GB	3.0	6.0	4.8	0.8	1
VD120-2T-1.5GB	4.0	5.8	7.0	1.5	2
VD120-2T-2.2GB	5.9	10.5	9.6	2.2	3
VD120-2T-4.0GB	8.9	14.6	13.0	3.7	5
Three-phase power supply: 380V,50/60Hz Range: -15%~20%					
VD120-4T-0.4GB	1.0	1.9	1.5	0.4	0.5
VD120-4T-0.7GB	1.5	4.0	2.5	0.8	1
VD120-4T-1.1GB	2.0	4.5	3.3	1.1	1.4
VD120-4T-1.5GB	3.0	5.0	3.8	1.5	2
VD120-4T-2.2GB	4.0	5.8	5.1	2.2	3
VD120-4T-3.0GB	5.5	9.2	8.0	3.0	4
VD120-4T-4.0GB	6.5	11.0	9.6	4.0	5.5
VD120-4T-5.5GB	8.9	14.6	13.0	5.5	7.5
VD120-4T-7.5GB	11.0	20.5	17.0	7.5	10

2.4 Product Appearances and Installation Dimension

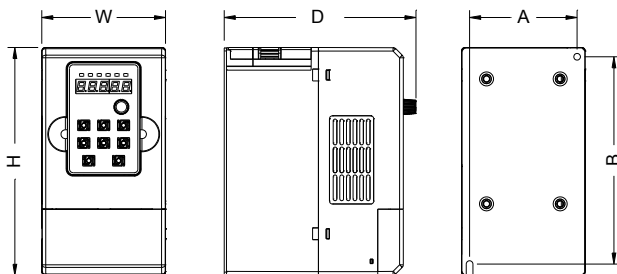

Adaptive mode (wall mounting type, three phase 380V: 0.4kW-2.2kW /Single phase, three phase 220V: 0.4kW-1.5kW)

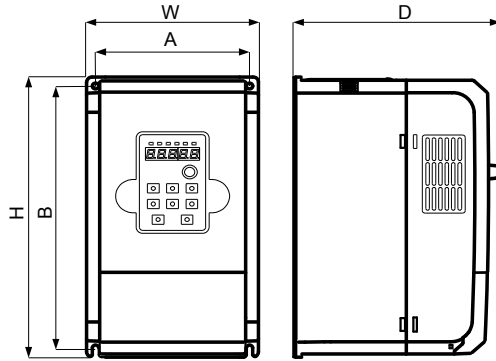

Adaptive mode(wall mounting type, three phase 380V: 3kW-7.5kW/three phase 220V: 2.2kW~4.0kW/single phase 220V:2.2kW)

Fig 2.4-1 Schematic diagram of product appearance and installation dimensions

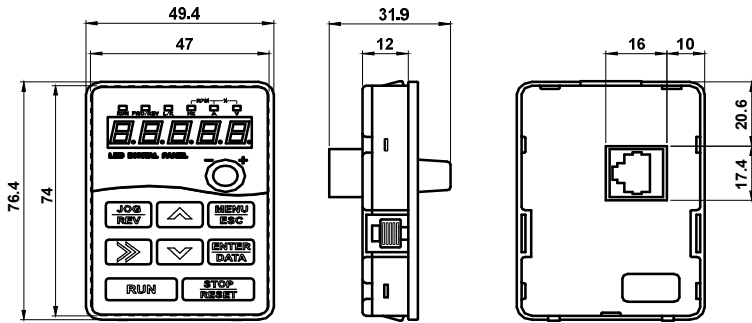

Schematic diagram of keyboard size

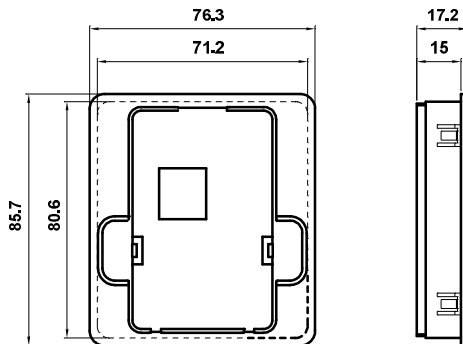

Schematic diagram of tray size

Fig 2.4-2 External lead keyboard and tray size (mm)

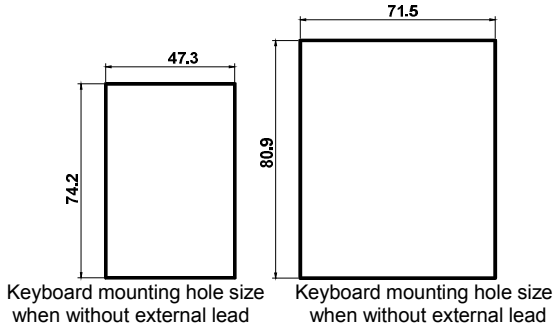

Table 2-2 Physical Dimensions and Installation Hole(mm)

Model	Mounting Hole (mm)		Physical Dimensions (mm)			Dieameter of Mounting Hole (mm)	Weight (kg)
	A	B	H	W	D		
Single phase: 220V, 50/60Hz Range: -15%~20%							
VD120-2S-0.4GB	73	141	155	84	130	4.5	1.4
VD120-2S-0.7GB							
VD120-2S-1.5GB							
VD120-2S-2.2GB	107.6	201	215	120	146	4.5	2.4
Three phase: 220V, 50/60Hz Range: -15%~20%							
VD120-2T-0.4GB	73	141	155	84	130	4.5	1.4
VD120-2T-0.7GB							
VD120-2T-1.5GB							
VD120-2T-2.2GB	107.6	201	215	120	146	4.5	2.4
VD120-2T-4.0GB							
Three phase: 380V, 50/60Hz Range:-15%~20%							
VD120-4T-0.4GB	73	141	155	84	130	4.5	1.4
VD120-4T-0.7GB							
VD120-4T-1.1GB							
VD120-4T-1.5GB							
VD120-4T-2.2GB							
VD120-4T-3.0GB	107.6	201	215	120	146	4.5	2.4
VD120-4T-4.0GB							
VD120-4T-5.5GB							
VD120-4T-7.5GB							

2.5 Recommended Brake Resistor Selection Table

Table 2-3 Recommended brake resistor selection table

Single phase, 220V			Three phase, 380V		
Model	Resistor	Power	Model	Resistor	Power
VD120-2S-0.4GB	≥200Ω	80W	VD120-4T-0.4GB	≥300Ω	150W
VD120-2S-0.7GB	≥150Ω	80W	VD120-4T-0.7GB	≥300Ω	150W
VD120-2S-1.5GB	≥100Ω	100W	VD120-4T-1.1GB	≥250Ω	150W
VD120-2S-2.2GB	≥70Ω	100W	VD120-4T-1.5GB	≥220Ω	150W
Three phase, 220V			VD120-4T-2.2GB	200Ω	300W
Model	Resistor	Power	VD120-4T-3.0GB	≥150Ω	300W
VD120-2T-0.4GB	≥150Ω	150W	VD120-4T-4.0GB	≥130Ω	300W
VD120-2T-0.7GB	≥110Ω	150W	VD120-4T-5.5GB	≥90Ω	400W
VD120-2T-1.5GB	≥100Ω	250W	VD120-4T-7.5GB	≥65Ω	500W
VD120-2T-2.2GB	≥65Ω	300W	-	-	-
VD120-2T-4.0GB	≥45Ω	400W	-	-	-

2.6 Warranty Introduction

For inverter manufactured by our factory, since the date of manufacture, under normal condition application, if inverter failed or damaged within warranty period, the manufacturer response for repair. If inverter is without in warranty period, user response for reasonable repair charge.

WARNING

- Free warranty only refers to the frequency converter
- Please keep the machine outer packing boxes and other packaging materials, to facilitate future inverter relocation or repair and other logistics transportation

2.6.1 In the warranty period, the following reasons lead to the failure of the inverter and damage, the user must bear part of the maintenance costs.

- ① The machine failure caused by the user does not use the user manual or beyond the standard specifications range use;
- ② The machine failure caused by the user repair and modify;
- ③ The machine failure caused by the user custody, maintenance improper.
- ④ Damage caused when the inverter is used for abnormal function;
- ⑤ The machine failure due to fires, floods, salt corrosion, corrosive gases, earthquake, storm, lightning, abnormal voltage or other non resistance caused by damage to the machine.

2.6.2 Relevant service charges will be calculated in accordance with the manufacturer's unified standard, if there is a contract, it is handled according to the relevant provisions of the contract.

Chapter 3 Mechanical and Electrical Installation

3.1 Standard Wiring Diagram

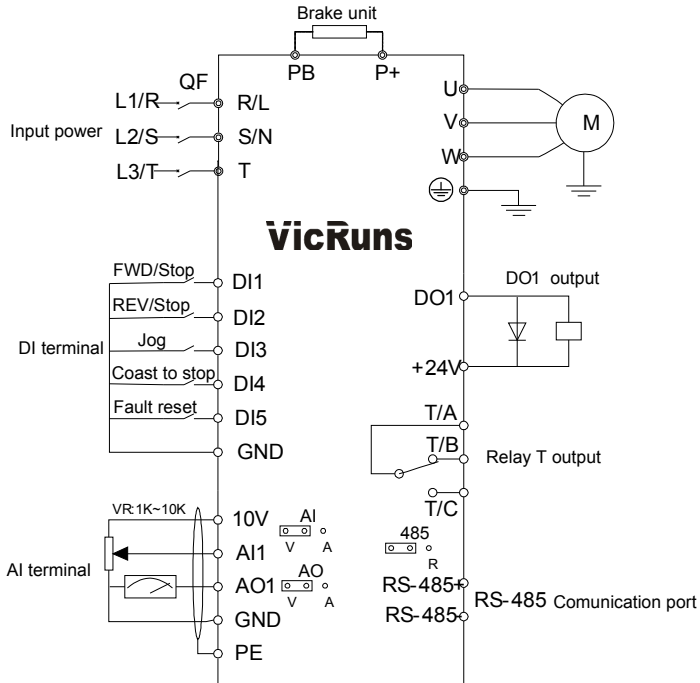
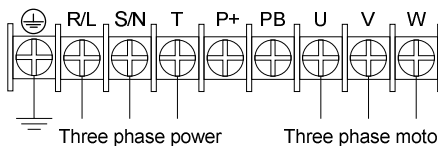

Fig 3.1-1 Schematic diagram of inverter standard wiring

Precautions are as follows:

- 1) Terminal ⊙ refers to Main circuit terminal, terminal ○ refers to control circuit terminal;
- 2) B which is followed the product model represents standard models built-in brake unit;
- 3) Braking resistor's selection is based on the user demand. refer to Table 2-4;
- 4) Signal lines and power line must be separated alignments, if you want to control cables and power cable cross, let them cross by 90 degree angle. It is best to choose shielded twisted-pair cabling for analogue signal, the selection of power cable is shield three-core cable(The specification should enlarge a class as much as the ordinary electric cables), or follow the inverter user manual.

3.2 Main Circuit Terminals



Three phase 380V: 0.4kW-2.2kW/Three phase, Signal phase 220V: 0.4kW-1.5kW

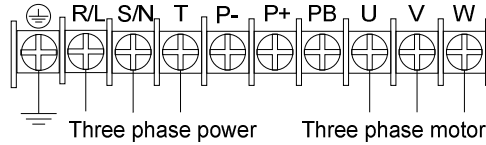

Three phase 380V: 3kW-7.5kW/Three phase 220V: 2.2kW~4.0kW/Signal phase 220V: 2.2kW

Fig 3.2-1 Schematic diagram of main circuit wiring

3.2.1 Function Instruction of Main Circuit Terminals

Table 3-1 Function Instruction of main circuit terminals

Terminals	Function Instruction
R/L, S/N, T	Power input terminals, external the ac power of grid rated voltage
U, V, W	Output terminal of 3phase power supply, external connection of AC 3phase motor
P+, PB	External connection of braking resistor terminal
P+, P-	Voltage positive and negative terminals on DC side
	Grounding terminal

DANGER

- The voltage class of VD120 series inverter 3phase power has two grades: 220V, 380V, before connecting power, please make sure the power class on inverter nameplate is the same with the accessing power. Otherwise do not connect.

3.3 Control Circuit Terminal

3.3.1 Schematic diagram of control board layout

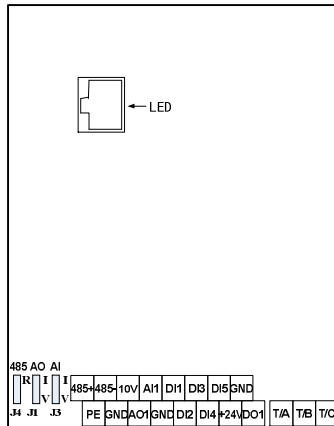

Fig 3.3-1 Schematic diagram of control board layout

3.3.2 Function Description of Control Circuit Terminal

Table 3-1 Function description of control circuit terminal

Type	Terminal Sign	Terminal Name	Function
Power Supply	10V-GND	10V power supply	<ol style="list-style-type: none"> 1. Provide 10V power supply for external-units. 2. It is generally used as the external potentiometer power. The potentiometer resistance range is 1kΩ~10KΩ. 3. Maximum output current 10mA.
	+24V-GND	24V power supply	<ol style="list-style-type: none"> 4. Provide +24V power supply for external units, only used as the working power supply of digital output terminals. 5. The maximum output current 100mA. 6. Don't use this power as an external power supply.
Communication	485+-485-	RS-485 communication terminals	Standard RS-485 communication terminal, should use twisted pair cable
Analog Input	AI1-GND	Analog input terminal 1	Support 0V~10V voltage or 0/4Ma~20mA current input, selected by AI jumpers, default to 0V~10V voltage input.
Digital Input	DI1-GND	Digital input terminal 1	Multi-function digital input, the function set by F5-01~F5-05.
	DI2-GND	Digital input terminal 2	
	DI3-GND	Digital input terminal 3	
	DI4-GND	Digital input terminal 4	
	DI5-GND	Digital input terminal 5	
Analog Output	AO1-GND	Analog output terminal 1	Support 0V~10V voltage or 0/4mA~20mA current output, selected by jumper J3, default to 0V~10V voltage output
Digital Output	DO1	Digital output 1	<ol style="list-style-type: none"> 1. Optical coupling isolation, dual polarity open collector output; 2. Pull-up voltage range: 5V~24V(pull-up resistance range: 0.48kΩ~10kΩ); 3. Output current range: 2mA~50mA.

Relay Output	T1/A-T1/B	Relay T1 normally closed terminal	Contact driving capacity: AC250V, 3A; DC30V, 5A
	T1/A-T1/C	Relay T1 normally open terminal	
Shield Ground	PE	Shield cable ground terminal	<ol style="list-style-type: none">1. Used to control cable shield grounding, when the interference is big on site or control cable is too long, the PE should be well grounded to reduce EMC affect.2. PE terminal is not allowed to connect with power N line, otherwise will damaged the inverter.

Chapter 4 Operation and Display

4.1 Introduction to Operation and Display Interface

With the operation panel, it can perform such operations on the inverter as function parameter modification, inverter working status monitoring and inverter run control (startup and stop). Refer to Fig 4-1 for the physical appearance and functional zone of the operation panel:

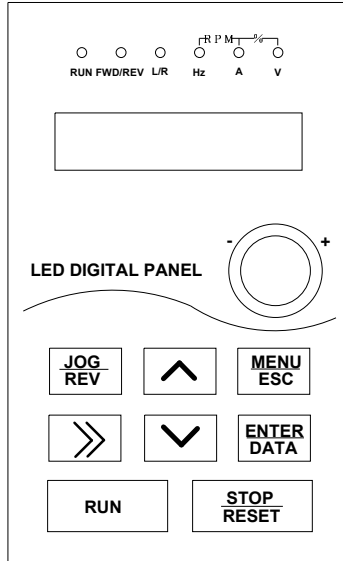





Fig 4.1-1 Operation panel schematic

4.1.1 Keyboard Button Description

Buttons	Name	Function Description
	Programming key	Enter or escape from the first level menu and remove the parameters quickly
	Enter key	Enter the menu step-by-step Confirm parameters
	UP key	Increase data or function code progressively
	DOWN key	Decrease data or function code progressively
	Right-shift key	Move right to select the displaying parameters circularly in stopping and running mode. Select the parameters modifying digit during the parameter modification

	Run key	This key is used to operate on the inverter in key operation mode
	Stop/Reset key	This key is used to stop in running state and it is limited by function code F7-01
	Quick key	The function of this key is confirmed by function code FA-01

4.1.2 Description of Function LED Indicator

Name	Description
RUN	When it is off, it indicates the inverter is in stop status; when it is on, it indicates the rotation status; light flashes that inverter in automatic running.
FWD/REV	It is the LED indicator for forward/reverse rotation. When it is on, it indicates the inverter is in forward rotation status; when it is off, it indicates the inverter is in reverse rotation
L/R	When it's off, it indicates the keypad operation control status; when it's on, it indicates the terminal operation control status; when it's flicker, it indicates the remote operation control status
Hz	The unit of frequency(Hz)
A	The unit of current(A)
V	The unit of voltage(V)
RPM	The unit of rotation speed(RPM)
%	Unit:%

Chapter 5 Function Parameter Table

The symbols in the function table are described as follows:

- It indicates that the parameter setup value can be modified when the inverter is in run state;
- ◎—It indicates that the parameter setup value cannot be modified when the inverter is in the run state;
- It indicates that the numerical value of the parameter is the actually measured value, which cannot be modified;
- ☆—It indicates this parameter is "Factory default parameter" and can be set only by the manufacturer.

F0 Basic Parameter Group				
Function Code	Parameter Name	Setting Range	Factory Default Value	Property
F0-00	Motor Control Mode	0: V/F control 1: SVC	0	◎
F0-01	Running Command Source Selection	0: Control panel command source (L/R OFF) 1: Terminal command source (L/R ON) 2: Communication command source (L/R flashes)	0	○
F0-02	Main Frequency Source A Selection	0: Digital setting (F0-09, UP/DOWN can be modified, no memory when power failure) 1: Digital setting (F0-09, UP/DOWN can be modified, memory when power failure) 2: AI1 3: Reserved 4: Reserved 5: PULSE setting 6: MS reference 7: Simple PLC 8: PID 9: Communication setting 10: Keypad potentiometer	10	◎
F0-03	Main Frequency A Gain	0.000~10.000	1.000	○
F0-04	Auxiliary Frequency Source B Selection	Same as F0-02 (Main Frequency Source A Selection)	0	◎

F0-05	Frequency Source Superposition Selection	<p>Unit's digit: frequency source selection</p> <p>0: Main frequency source A</p> <p>1: Main auxiliary operation result (operational relationship is determined by ten bits)</p> <p>2: Main frequency source A switching with auxiliary frequency source B</p> <p>3: Main frequency source A switching with main and auxiliary operation result</p> <p>Ten's digit: frequency source main and auxiliary operation relationship</p> <p>0: Main + auxiliary</p> <p>1: Main – auxiliary</p> <p>2: Max value of the two</p> <p>3: Min value of the two</p>	0x00	○
F0-06	Auxiliary Frequency Source B Range Reference Selection when Superimposed	<p>1: Relative to the max frequency</p> <p>2: Relative to frequency source A</p>	0	○
F0-07	Auxiliary Frequency Source B Range when Superimposed	0%~150%	100%	○
F0-08	Auxiliary Frequency Source B Offset Frequency when Superimposed	0.00Hz~max frequency F0-10	0.00Hz	○
F0-09	Digital Setting Frequency	0.00Hz~max frequency (F0-10)	50.00Hz	○
F0-10	Max Frequency	50.00Hz~600.00Hz	50.00Hz	◎
F0-11	Frequency Upper Limit Source	<p>0: F0-12 setting</p> <p>1: AI1</p> <p>2: Reserved</p> <p>3: Reserved</p> <p>4: PULSE setting</p> <p>5: Communication setting</p>	0	◎
F0-12	Frequency Upper Limit	Frequency lower limit F0-14~max frequency F0-10	50.00Hz	○

F0-13	Frequency Upper Limit Offset	0.00Hz~max frequency F0-10	0.00Hz	○
F0-14	Frequency Lower Limit	0.00Hz~frequency upper limit F0-12	0.00Hz	○
F0-15	Frequency Command Resolution	2: 0.01Hz	2	●
F0-16	Frequency Command UP/DOWN Reference in Running	0: Running frequency 1: Set frequency	0	◎
F0-17	Digital Setting Frequency Memory Selection when Stop	0: No memory 1: Memory	0	○
F0-18	Acceleration Time 1	0.00s~65000s	Model dependent	○
F0-19	Deceleration Time 1	0.00s~65000s	Model dependent	○
F0-20	Acceleration / Deceleration Time Unit	0: 1s 1: 0.1s 2: 0.01s	1	◎
F0-21	Acceleration and Deceleration Time Reference Frequency	0: Max frequency (F0-10) 1: Setting frequency 2: 100Hz	0	◎
F0-22	Command Source Bound Frequency Source	Unit's digit: Operation panel command binding frequency source selection 0: No binding 1: Digital setting frequency 2: AI1 3: Reserved 4: Reserved 5: PULSE setting 6: MS reference 7: Simple PLC 8: PID 9: Communication setting Ten's digit: terminal command binding frequency source selection Hundred's digit: communication	0x0000	○

		command binding frequency source selection Thousand's digit: Automatic operation command binding frequency source selection		
F0-23	Communication Protocol Selection	0: Modbus	0	●
F1 Start/Stop Control Group				
Function Code	Parameter Name	Setting Range	Factory Default Value	Property
F1-00	Start Mode	0: Direct start 1: Speed tracking restart 2: Pre excitation start (AC asynchronous)	0	○
F1-01	Starting Frequency	0.00Hz~10.00Hz	0.50Hz	○
F1-02	Startup Frequency Holding Time	0.00s~100.0s	0.0s	◎
F1-03	Starting DC Braking Current/ Pre-excitation Current	0%~100%	0%	◎
F1-04	Starting DC Braking Time / Pre-excitation Time	0.0s~100.0s	0.0s	◎
F1-05	Speed Tracking Mode	0: Starting from the stop frequency 1: Starting from zero speed 2: Starting from the maximum frequency	0	◎
F1-06	Speed Tracking Speed	1~100	20	○
F1-07	Speed Tracking Current	100%~150%	125%	◎
F1-08	Stop Mode	0: Decelerate to stop 1: Coast to stop	0	○
F1-09	Initial Frequency of Stop DC Braking	0.00Hz~max frequency	0.00Hz	○

F1-10	Waiting Time of Stop DC Braking	0.0s~100.0s	0.0s	<input type="radio"/>
F1-11	Stop DC Braking Current	0%~100%	0%	<input type="radio"/>
F1-12	Stop DC Braking Time	0.0s~100.0s	0.0s	<input type="radio"/>
F1-13	Stop Frequency	0.00Hz~max frequency	0.50Hz	<input type="radio"/>
F1-14	Stop Frequency Holding Time	0.0s~60.0s	0.0s	<input type="radio"/>
F1-15	Restart Selection Upon Power Failure	0: Enabled 1: Disabled	0	<input type="radio"/>
F1-16	Waiting Time of Restart Upon Power Failure	0.0s~60.0s	0.0s	<input type="radio"/>
F1-17	Operation Mode of Set Frequency is Lower than the Frequency Lower Limit	0: Running with frequency lower limit 1: Stop 2: Zero speed running	0	<input type="radio"/>
F1-18	Start Selection of Set Frequency is Lower than the Start Frequency	0: Don't start 1: Zero speed running	1	<input checked="" type="radio"/>
F1-19	Run Direction	0: Same direction 1: Opposite direction	0	<input type="radio"/>
F1-20	Reverse Control Enable	0: Allow reverse 1: Prohibit reverse	0	<input type="radio"/>
F1-21	FWD/REV Rotation Dead-zone Time	0.0s~3000.0s	0.0s	<input type="radio"/>
F1-22	Dynamic Braking Enable	0: Disabled 1: Enabled	0	<input type="radio"/>
F1-23	Braking Usage Rate	0%~100%	100%	<input type="radio"/>

F1-24	Over-excitation Effective Range	0: The whole is valid 1: Only overpressure stall enable effectively 2: Only deceleration process effectively 3: The whole is invalid	1	⊙
F1-25	Over-excitation Gain	0~200	100	○
F1-26	Over-excitation Filter Coefficients	0~10	3	○
F1-27	Acceleration/Deceleration Mode	0: Straight-line acceleration/deceleration 1: S curve acceleration/deceleration A 2: S curve acceleration/deceleration B	0	⊙
F1-28	Time Ratio of S Curve Start Segment	0.0%~(100.0%-F1-29)	30.0%	⊙
F1-29	Time Ratio of S Curve End Segment	0.0%~(100.0%-F1-28)	30.0%	⊙
F2 Motor Parameter				
Function Code	Parameter Name	Setting Range	Factory Default Value	Property
F2-00	Motor Type Selection	0: Ordinary asynchronous motor 1: Frequency conversion asynchronous motor	0	⊙
F2-01	Rated Motor Power	0.1kW~11.0kW	Model dependent	⊙
F2-02	Rated Motor Voltage	1V~1000V	Model dependent	⊙
F2-03	Rated Motor Current	0.01A~100.00A	Model dependent	⊙
F2-04	Rated Motor Frequency	0.01Hz~max frequency	Model dependent	⊙
F2-05	Rated Motor Rotation Speed	1RPM~65535RPM	Model dependent	⊙
F2-06	Asynchronous Motor Stator Resistance	0.001Ω~65.535Ω	Tune parameter	⊙

F2-07	Asynchronous Motor Rotor Resistance	0.001Ω~65.535Ω	Tune parameter	⊙
F2-08	Asynchronous Motor Leakage Inductive Reactance	0.01mH ~655.35mH	Tune parameter	⊙
F2-09	Asynchronous Motor Mutual Inductive Reactance	0.1mH~6553.5mH	Tune parameter	⊙
F2-10	Asynchronous Motor No-load Current	0.01A~F2-03	Tune parameter	⊙
F2-26	Tune Selection	0: No operation 1: Asynchronous motor static tuning 2: Asynchronous motor complete tuning	0	⊙
F3 Motor Vector Control Parameter				
Function Code	Parameter Name	Setting Range	Factory Default Value	Property
F3-00	Speed Loop Proportional Gain 1	01~100	30	○
F3-01	Speed Loop Integral Time 1	0.01s~10.00s	0.50s	○
F3-02	Switch Frequency 1	0.00Hz~F3-05	5.00Hz	○
F3-03	Speed Loop Proportional Gain 2	1~100	20	○
F3-04	Speed Loop Integral Time 2	0.01s~10.00s	1.00s	○
F3-05	Switch Frequency 2	F3-02~max frequency	10.00Hz	○
F3-06	Vector Control Slip Gain	20%~200%	100%	○
F3-07	Speed Loop Filter Time Constant	0.000s~0.100s	0.000s	○

F3-09	Motor Torque Upper Limit Source	0: Encode F3-10 setting 1: AI1 2: AI2 3: AI3 4: PULSE setting 5: Communication setting 6: MIN (AI1, AI2) 7: MAX (AI1, AI2) The full scale of options 1~7 corresponding to the F3-10	0	○
F3-10	Digital Setting for Motor Torque Upper Limit	0%~200.0%	150.0%	○
F3-11	Brake Torque Upper Limit Source	0: Encode F3-12setting 1: AI1 2: AI2 3: AI3 4: PULSE setting 5: Communication setting 6: MIN (AI1, AI2) 7: MAX (AI1, AI2) The full scale of options 1~7 corresponding to the F3-12	0	○
F3-12	Digital Setting for Brake Torque Upper Limit	0%~200.0%	150.0%	○
F3-13	Excitation Adjustment Proportional Gain	0~60000	2000	○
F3-14	Excitation Adjustment Integral Gain	0 ~60000	1300	○
F3-15	Torque Adjustment Proportional Gain	0~60000	2000	○
F3-16	Torque Adjustment Integral Gain	0~60000	1300	○
F3-17	Speed Loop Integral Separation Enable	0: Disabled 1: Enabled	0	○

F3-20	Max Weak Magnetic Current	1%~300%	50%	☉
F3-21	Weak Magnetic Automatic Gain Adjustment	10%~500%	100%	○
F3-22	Weak Magnetic Integral Multiples	2~10	2	○
F3-23	Torque Boost Coefficient	0.0%~60.0%	10.0%	○
F3-24	Torque Boost Cutoff Frequency	0.00Hz~max frequency	20.00Hz	☉
F3-25	Exciting Current Compensation Gain	0~500	0	○
F3-26	Torque Current Compensation Gain	0~500	0	○
F3-27	Torque Response Gain	1~1000	10	○
F4 Motor V/F Control Parameter				
Function Code	Parameter Name	Setting Range	Factory Default Value	Property
F4-00	V/F Curve Setting	0: Straight line V/F 1: Multipoint V/F 2: Square V/F 3: 1.2#power V/F 4: 1.4#power V/F 5: 1.6#power V/F 6: 1.8#power V/F 7: V/F complete separation mode 8: V/F half separation mode	0	☉
F4-01	Torque Boost Mode Selection	0: Automatic torque boost 1: Manual torque boost	0	☉
F4-02	Manual Torque Boost	0.0%~30.0%	Model dependent	○
F4-03	Manual Torque Boost Cutoff Frequency	0.00Hz~max frequency	50.00Hz	☉

F4-04	MS V/F Frequency Point 1	0.00Hz~F4-06	0.00Hz	◎
F4-05	MS V/F Voltage Point 1	0.0%~100.0%	0.0%	◎
F4-06	MS V/F Frequency Point 2	F4-04~F4-08	0.00Hz	◎
F4-07	MS V/F Voltage Point 2	0.0%~100.0%	0.0%	◎
F4-08	MS V/F Frequency Point 3	F4-06~Rated motor frequency (F2-04)	0.00Hz	◎
F4-09	MS V/F Voltage Point 3	0.0%~100.0%	0.0%	◎
F4-10	V/F Slip Compensation Gain	0.0%~200.0%	20.0%	◎
F4-12	V/F Oscillation Suppression Gain	0~100	Model dependent	○
F4-14	The Separation of V/F Voltage Source	0: Digital setting (F4-15) 1: AI1 2: Reserved 3: Reserved 4: PULSE setting 5: MS instruction 6: Simple PLC 7: PID 8: Communication given Remark: 100% corresponding rated motor voltage	0	○
F4-15	V/F Separation Voltage Digital Setting	0V~rated motor voltage	0V	○
F4-16	V/F Separation Voltage Rise Time	0.0s~1000.0s Remark: Indication the time that 0V rise to rated motor voltage	5.0s	○
F4-17	V/F Separation Voltage Fall Time	0.0s~1000.0s Remark: Indication the time that rated motor voltage drop to 0V	5.0s	○

F5 Input Terminal				
Function Code	Parameter Name	Setting Range	Factory Default Value	Property
F5-00	Terminal Command Mode	0: Two-line mode 1 1: Two-line mode 2 2: Three-line mode 1 3: Three-line mode 2 4: Alternate control 5: Back and forth control	0	◎
F5-01	DI1 Terminal Function Selection	0: No function 1: Forward running (FWD) 2: Reverse running (REV)	1	◎
F5-02	DI2 Terminal Function Selection	3: Three-line mode run control 4: Forward Jog (FJOG) 5: Reverse Jog (RJOG)	2	◎
F5-03	DI3 Terminal Function Selection	6: Coast to stop 7: Run pause	4	◎
F5-04	DI4 Terminal Function Selection	8: Fault reset (RESET) 9: External fault normally open input 10: External fault normally closed input	6	◎
F5-05	DI5 Terminal Function / HDI1 Pulse Input Function Selection (Optional)	11: Terminal UP 12: Terminal DOWN 13: UP/DOWN setting clear (terminal, keyboard) 14: Switching frequency source 15: Frequency source A switching with preset frequency 16: Frequency source B switching with preset frequency 17: MS reference terminal 1 18: MS reference terminal 2 19: MS reference terminal 3 20: MS reference terminal 4 21: Acceleration and deceleration time selection terminal 1 22: Acceleration and deceleration time selection terminal 2 23: PULSE frequency input (Only effective for HDI1) 24: Control command switch terminal 1 25: Control command switch terminal 2	8	◎

		26: Immediate DC braking 27: Deceleration DC braking 28: External stop terminal 1 (Only effective for keypad control) 29: External stop terminal 2 (According to the deceleration time 4) 30: Emergency stop 31: PID pause 32: PID integral pause 33: Reverse PID action direction 34: PID parameter switching 35: PLC pause 36: PLC state reset 37: Swing frequency pause 38: Swing frequency reset 39: Switching between speed control and torque control 40: Torque control prohibit 41: Acceleration and deceleration prohibit 42: Reverse prohibit 43: Frequency modification prohibit 44: Counter input 45 Counter reset 46: Length count input 47: Length reset 48: Motor selection terminal 49: Reserved 50: User defined failure 1 51: User defined failure 2 52: Cleared the running time 53: Switching between two-line and three-line mode (Switch is invalid in running) 54~59: Reserved		
F5-10	DI1 Terminal Mode Selection 1 Effectively	Unit's digit: DI1 0: High level effective 1: Low level effective Ten's digit: DI2, same as above Hundred's digit: DI3, same as above Thousand's digit: DI4, same as above Ten thousand's digit: DI5, same as above	0x00000	⊙
F5-12	DI Filter Time	0.000s~1.000s	0.010s	○

F5-13	DI1 Close Delay Time	0.0s~3600.0s	0.0s	⊙
F5-14	DI2 Close Delay Time	0.0s~3600.0s	0.0s	⊙
F5-15	DI3 Close Delay Time	0.0s~3600.0s	0.0s	⊙
F5-16	DI1 Open Delay Time	0.0s~3600.0s	0.0s	⊙
F5-17	DI2 Open Delay Time	0.0s~3600.0s	0.0s	⊙
F5-18	DI3 Open Delay Time	0.0s~3600.0s	0.0s	⊙
F5-19	Terminal UP/DOWN change rate	0.001Hz/s~65.535Hz/s	1.000Hz/s	○
F5-20	AI Curve Selection	AI1 curve selection 1: Curve 1 (2 point, see F5-22~F5-26) 2: Curve 2 (2 point, see F5-27~F5-31) 3: Curve 3 (2 point, see F5-32~F5-36) 4: Curve 4 (4 point, see b2~00-b2-07) 5: Curve 5 (4 point, see b2-08~b2-15)	1	○
F5-21	AI is Lower than Min Input Setting Selection	AI1 is lower than min input setting selection 0: Corresponding to the min input setting 1: 0.0%	0	○
F5-22	AI Curve 1 Min Input	-10V~F5-24	0.00V	○
F5-23	Corresponding Setting of AI Curve 1 Min Input	-100.0%~+100.0%	0.0%	○
F5-24	AI Curve 1 Max Input	F5-22~+10.00V	10.00V	○
F5-25	Corresponding Setting of AI Curve 1 Max Input	-100.0%~+100.0%	100.0%	○
F5-26	AI 1 Filter Time	0.00s~10.00s	0.10s	○

F5-27	AI Curve 2 Min Input	-10.00V~F5-29	0.00V	○
F5-28	Corresponding Setting of AI Curve 2 Min Input	-100.0%~+100.0%	0.0%	○
F5-29	AI Curve 2 Max Input	F5-27~+10.00V	10.00V	○
F5-30	Corresponding Setting of AI Curve 2 Max Input	-100.0%~+100.0%	100.0%	○
F5-31	AI 2 Filter Time	0.00s~10.00s	0.10s	○
F5-32	AI Curve 3 Min Input	-10.00V~F5-34	0.00V	○
F5-33	Corresponding Setting of AI Curve 3 Min Input	-100.0%~+100.0%	0.0%	○
F5-34	AI Curve 3 Max Input	F5-32~+10.00V	10.00V	○
F5-35	Corresponding Setting of AI Curve 3 Max Input	-100.0%~+100.0%	100.0%	○
F5-36	AI3 Filter Time	0.00s~10.00s	0.10s	○
F5-37	Pulse Min Input	0.00kHz~F5-39	0.00kHz	○
F5-38	Corresponding Setting of Pulse Min Input	-100.0%~+100.0%	0.0%	○
F5-39	Pulse Max Input	F5-37~100.00kHz	50.00kHz	○
F5-40	Corresponding Setting of Pulse Max Input	-100.0%~+100.0%	100.0%	○
F5-41	PULSE Filter Time	0.00s~10.00s	0.10s	○
F5-42	Travel Switch Lock Time	0.00s~10.00s	1.00s	○

F6 Output Terminal

Function	Parameter	Setting Range	Factory	Property
----------	-----------	---------------	---------	----------

Code	Name		Default Value	
F6-00	DO1 Terminals Output Mode Selection	0: HDO1 pulse output (optional) 1: Switch output	1	○
F6-01	DO1 Output Terminals Function Selection	0: No output 1: Inverter in running 2: Ready for run 3: Fault output 1 (no output when continue to run) 4: Fault output 2 (no output undervoltage or continue to run) 5: Warning output 3 (output when fault) 6: Output undervoltage 7: Frequency level detection FDT1 output 8: Frequency level detection FDT2 output 9: Frequency reached 10: Frequency 1 reached output 11: Frequency 2 reached output 12: Zero speed running 1 (no output when stop) 13: Zero speed running 2 (output when stop) 14: Frequency upper limit reached 15: Frequency lower limit reached 1 (no output when stop) 16: Frequency lower limit reached 2 (output when stop) 17: Current 1 reached output 18: Current 2 reached output 19: Zero current state 20: Output current limit exceeded 21: Motor overload pre-alarm 22: Inverter overload pre-alarm 23: During the load 24: Set Count value reached 25: Designated count value reached 26: Length reached 27: Module temperature reached 28: Reserved 29: Current running time reached 30: Accumulative running time reached 31: Accumulative power-on time	0	○
F6-02	Relay T1 Function Selection		0	○

		reached 32: Timing reached output 33: PLC circulation output 34: Frequency limit 35: Torque limit 36: Reverse running 37: AI1 input limit 38: Reserved 39: Communication setting 40: Reserved 41: Timing braking (power on braking) 42: Inverter in running (jog no output)		
F6-06	DO Output Terminal Effective State Selection	Unit's digit: HDO1 0: Positive logic 1: Anti-logic Ten's digit: RELAY1, same as above	0x00	○
F6-07	HDO1 Closing Delay	0.0s~3600.0s	0.0s	○
F6-08	T1 Closing Delay	0.0s~3600.0s	0.0s	○
F6-12	HDO1 Output Function Selection	0: Running frequency 1: Set frequency	0	○
F6-13	AO1 Output Function Selection	2: Output current (2 times of rated motor current) 3: Output torque 4: Output power 5: Output voltage (1.2 times of rated motor voltage) 6: PULSE input (100% corresponding 100.0kHz) 7: AI1 8: Reserved 9: Reserved 10: Length 11: Count value 12: Communication setting 13: Motor rotate speed 14: Output current (100.0% corresponding 100.00A) 15: Output voltage (100.0% corresponding 1000.0A) 16: Reserved	0	○

F6-15	HDO1 Output Max Frequency	0.01kHz~100.00kHz	50.00kHz	○
F6-16	AO1 Output Voltage Lower Limit	0.00V~10.00V	0.00V	○
F6-17	Corresponding Setting Value of AO1 Output Voltage Lower Limit	0.0%~F6-19	0.0%	○
F6-18	AO1 Output Voltage Upper Limit	0.00V~10.00V	10.00V	○
F6-19	Corresponding Setting Value of AO1 Output Voltage Upper Limit	F6-17~100.0%	100.0%	○
F6-20	AO1 Output Filter Time	0.00s~10.00s	0.00s	○
F6-26	AO1 Output Type	0: Voltage 1: Current	0	○
F6-27	HDO1 Disconnect Delay	0.0s~3600.0s	0.0s	○
F6-28	T1 Disconnect Delay	0.0s~3600.0s	0.0s	○
F7 AIAO Keyboard and Display				
Function Code	Parameter Name	Setting Range	Factory Default Value	Property
F7-00	JOG / REV Key Function Selection	0: Invalid 1: Operation panel command channel and switching with remote command channel (terminal command channel or communication command channel) 2: FWD/REV switching 3: Forward jog 4: Reverse jog 5: Rapid debugging	3	◎
F7-01	STOP/RESET Key Stop Function	0: STOP/RES key stop function is valid only in keypad operation mode 1: STOP/RES key stop function all valid in any operation mode	0	○

<p>F7-02</p>	<p>LED Running Display Parameter 1</p>	<p>0000~0xFFFF Bit00: Running frequency 1 (Hz) Bit01: Setting frequency (Hz) Bit02: Bus voltage (V) Bit03: Output voltage (V) Bit04: Output current (A) Bit05: Output power (kW) Bit06: Output torque (%) Bit07: DI input state Bit08: DO output state Bit09: AI1 voltage (V) Bit10: Reserved Bit11: Reserved Bit12: Count value Bit13: Length value Bit14: Load speed display BIT15: PID setting</p>	<p>0x001F</p>	<p>○</p>
<p>F7-03</p>	<p>LED Running Display Parameter 2</p>	<p>0000~0xFFFF Bit00: PID feedback Bit01: PLC stage Bit02: PULSE input frequency (kHz) Bit03: Running frequency 2 (Hz) Bit04: Set torque (0.%) Bit05: Voltage before AI1 correction (V) Bit06: Reserved Bit07: Reserved Bit08: Line speed Bit09: Current power on time (Hour) Bit10: Current running time (Min) Bit11: PULSE input frequency (Hz) Bit12: Communication setting value Bit13: Encode feedback speed (Hz) Bit14: Main frequency A display (Hz) Bit15: Auxilliary frequency B display (Hz)</p>	<p>0x0000</p>	<p>○</p>
<p>F7-04</p>	<p>LED Display Stop Parameter</p>	<p>0000~0x3FFF Bit00: Set frequency (Hz) Bit01: Bus voltage (V) Bit02: DI input state Bit03: DO output state Bit04: AI1 voltage (V) Bit05: Reserved</p>	<p>0x0033</p>	<p>○</p>

		Bit06: Reserved Bit07: Count value Bit08: Length value Bit09: PLC stage Bit10: Load speed Bit11: PID setting Bit12: Pulse input frequency (kHz) Bit13: Set torque (0.1%)		
F7-05	The Second Line LED Running Display Parameters	0~15 corresponding bit0~bit15 of F7-02 16~31 corresponding bit0~bit15 of F7-03	4	○
F7-06	The Second Line LED Stop Display Parameters	0~13 corresponding bit0~bit13 of F7-05	1	○
F7-07	Load Speed Display Coefficient	0.0001~6.5000	1.0000	○
F7-08	Load Speed Display Decimal Places	0: 0 bit decimal place 1: 1 bit decimal place 2: 2 bit decimal place 3: 3 bit decimal place	1	○
F8 Protection Parameters				
Function Code	Parameter Name	Setting Range	Factory Default Value	Property
F8-00	Motor Overload Protection Selection	0: Disabled 1: Enabled	1	○
F8-01	Motor Overload Protection Gain	0.20~10.00	1.00	○
F8-02	Motor Overload Warning Coefficient	50%~100%	80%	○
F8-06	Overvoltage/over current Stall Mode Selection	0: Mode 0 1: Mode 1	≤11kW: 1	◎
			>11kW: 0	
F8-07	Overvoltage Stall Proportion Gain	0: Disabled 1~100	10	○
F8-08	Overvoltage Stall Integral Gain	0~100	5	○

F8-09	Overvoltage Stall Protection voltage	100.0VDC~800.0VDC	380VAC: 700.0VDC	○
			220VAC: 370.0VDC	
F8-10	Over current Stall Proportion Gain	0: Disabled 1~1000	20	○
F8-11	Over current Stall Integral Gain	0~1000	20	○
F8-12	Over current Stall Protection Current	100%~200%	160%	○
F8-13	Quick Start Over current Suppression Gain	0~100	30	○
F8-14	Short-circuit to Ground Upon Power-on	0: Invalid 1: Valid	1	○
F8-15	Input Phase Loss Protection Selection	0: Disabled 1: Enabled	1	○
F8-16	Output Phase Loss Protection Selection	0: Disabled 1: Enabled	1	○
F8-17	Offload Protection Selection	0: Invalid 1: Valid	0	○
F8-18	Offload Detection Level	0.0~100.0%	10.0%	○
F8-19	Offload Detection Time	0.0s~60.0s	1.0s	○
F8-24	Action Selection Upon Instantaneous Power Failure	0: Invalid 1: Decelerate 2: Decelerate to stop	0	○
F8-25	Voltage Restore Judgment Value Upon Instantaneous Power Failure	F8-27~100.0%	90.0%	○
F8-26	Voltage Restore Judgment Time Upon Instantaneous Power Failure	0.00s~100.00s	0.50s	○

F8-27	Voltage Judgment Value Upon Instantaneous Power Failure	60.0%~100.0% (Standard bus voltage)	80.0%	○
F8-28	Maximum Change of V/F Over Voltage Stall	0: No limit 1~30000	800	○
F9 Fault Record and Setting				
Function Code	Parameter Name	Setting Range	Factory Default Value	Property
F9-00	Fault Types for the First Time	0: No fault	-	●
F9-01	Fault Types for the Second Time	1: Acceleration over current (hardware) 2: Deceleration over current (hardware)	-	●
F9-02	Fault Types for the Third Time (Last Time)	3: Constant speed over current (hardware) 4: Acceleration over current (software) 5: Deceleration over current (software) 6: Constant speed over current (software) 7: Acceleration overvoltage 8: Deceleration overvoltage 9: Constant speed overvoltage 10: Under voltage 11: Motor overload 12: Inverter overload 13: Input phase loss 14: Output phase loss 15: Module overheat 16: Reserved 17: External fault 18: Communication abnormal 19: Current detection abnormal 20: Motor tune abnormal 21: EEPROM read-write fault 22: Disconnection detection fault 23: PID feedback lost at runtime 24: Motor short circuit to ground	-	●

		25: Reserved 26: Reserved 27: Running time reached 28: Power-on time reached 29: Buffer contactor overheating 30~34: Reserved 35: User-defined fault 1 36: User-defined fault 2 37: Offload 38: Fast current-limiting timeout 39~42: Reserved 43: Manufacturer defined fault		
F9-03	Frequency Upon the Third Time (Last Time) Fault	-	-	●
F9-04	Current Upon the Third Time (Last Time) Fault	-	-	●
F9-05	Bus Voltage Upon the Third Time (Last Time) Fault	-	-	●
F9-06	Input Terminal State Upon the Third Time (Last Time) Fault	-	-	●
F9-07	Output Terminal State Upon the Third Time (Last Time) Fault	-	-	●
F9-08	Inverter State Upon the Third Time (Last Time) Fault	-	-	●
F9-09	Power on Time Upon the Third Time (Last Time) Fault	-	-	●
F9-10	Running Time Upon the Second Time Fault	-	-	●
F9-13	Frequency Upon the	-	-	●

	Second Time Fault			
F9-14	Current Upon the Second Time Fault	-	-	●
F9-15	Bus Voltage Upon the Second Time Fault	-	-	●
F9-16	Input Terminal State Upon the Second Time Fault	-	-	●
F9-17	Output Terminal State Upon the Second Time Fault	-	-	●
F9-18	Inverter State Upon the Second Time Fault	-	-	●
F9-19	Power on Time Upon the Second Time Fault	-	-	●
F9-20	Running Time Upon the Second Time Fault	-	-	●
F9-23	Frequency Upon the First Time Fault	-	-	●
F9-24	Current Upon the First Time Fault	-	-	●
F9-25	Bus Voltage Upon the First Time Fault	-	-	●
F9-26	Input Terminal State Upon the First Time Fault	-	-	●
F9-27	Output Terminal State Upon the First Time Fault	-	-	●
F9-28	Inverter State	-	-	●

	Upon the First Time Fault			
F9-29	Power on Time Upon the First Time Fault	-	-	●
F9-30	Running Time Upon the First Time Fault	-	-	●
F9-33	Fault Automatic Reset Times	0~20	0	○
F9-34	Fault Automatic Reset Interval Time	0.1s~100.0s	1.0s	○
F9-35	Fault DO Action Selection During the Fault Automatic Reset	0: No action 1: Action	0	○
F9-36	Fault Protection Action Selection 1	Unit's digit: motor overload (11) 0: Coast to stop 1: Stop according to stop mode 2: Continue to run Ten's digit: input phase loss (13) 0: Coast to stop 1: Stop according to stop mode 2: Continue to run Hundred's digit: output phase loss (14) 0: Coast to stop 1: Stop according to stop mode 2: Continue to run Thousand's digit: external fault (17) 0: Coast to stop 1: Stop according to stop mode 2: Continue to run Ten thousand's digit: communication abnormal (18) 0: Coast to stop 1: Stop according to stop mode 2: Continue to run	0x00000	○
F9-37	Fault	Unit's digit: reserved	0x00000	○

	Protection Action Selection 2	<p>Ten's digit: parameter read-write abnormal (21)</p> <p>0: Coast to stop</p> <p>1: Stop according to stop mode</p> <p>2: Continue to run</p> <p>Hundred's digit: running time reached (27)</p> <p>0: Coast to stop</p> <p>1: Stop according to stop mode</p> <p>2: Continue to run</p> <p>Thousand's digit: reserved</p> <p>Ten thousand's digit: reserved</p>		
F9-38	Fault Protection Action Selection 3	<p>Unit's digit: user-defined fault 1 (35)</p> <p>0: Coast to stop</p> <p>1: Stop according to stop mode</p> <p>2: Continue to run</p> <p>Ten's digit: user-defined fault 2 (36)</p> <p>0: Coast to stop</p> <p>1: Stop according to stop mode</p> <p>2: Continue to run</p> <p>Hundred's digit: power on time reached (28)</p> <p>0: Coast to stop</p> <p>1: Stop according to stop mode</p> <p>2: Continue to run</p> <p>Thousand's digit: offload (37)</p> <p>0: Coast to stop</p> <p>1: Stop according to stop mode</p> <p>2: Decelerate to 7% of the rated motor frequency continue running, automatically restored to the set frequency operation when no offload (Acceleration and deceleration time is Fb-07 and Fb-08)</p> <p>Ten thousand's digit: PID feedback lost when running (23)</p> <p>0: Coast to stop</p> <p>1: Stop according to stop mode</p> <p>2: Continue to run</p>	0x00000	○
F9-39	Fault Protection Action Selection 4	<p>Unit's digit: Disconnection detection fault (22)</p> <p>0: Coast to stop</p> <p>1: Stop according to stop mode</p> <p>2: Continue to run</p> <p>Ten's digit: reserved</p>	0x00000	○

		Hundred's digit: reserved Thousand's digit: reserved Ten thousand's digit: reserved		
F9-40	Continue Running Frequency Selection at Failure	0: Run to the current running frequency 1: Run at set frequency 2: Run at frequency upper limit 3: Run at frequency lower limit 4: Run at abnormal standby frequency	0	○
F9-41	Abnormal Standby Frequency	0.0%~100.0% (100.0% corresponding max frequency F0-10)	100.0%	○
FA Process PID				
Function Code	Parameter Name	Setting Range	Factory Default Value	Property
FA-00	PID Given Source	0: FA-01 setting 1: AI1 2: Reserved 3: Reserved 4: PULSE setting 5: Communication setting 6: Multi-reference setting 7: Keypad potentiometer	0	○
FA-01	PID Digital Giving	0.0%~100.0%	50.0%	○
FA-02	PID Feedback Source	0: A1 1: Reserved 2: Reserved 3: Reserved 4: PULSE setting 5: Communication setting	0	○
FA-03	PID Action Direction	0: Positive action 1: Anti-action	0	○
FA-04	PID Given Feedback Range	0~65535	1000	○
FA-05	Proportion Gain Kp1	0.0~100.0	20.0	○
FA-06	Integral Time Ti1	0.01s~10.00s	2.00s	○
FA-07	Differential	0.000s~10.000s	0.000s	○

	Time Td1			
FA-08	PID Reverse Cut-off Frequency	0.00Hz~max frequency	0.00Hz	○
FA-09	PID Deviation Limit	0.0%~100.0%	0.0%	○
FA-10	PID Differential Limiting	0.00%~100.00%	0.10%	○
FA-11	PID Given Change Time	0.00s~650.00s	0.00s	○
FA-12	PID Feedback Filter Time	0.00s~60.00s	0.00s	○
FA-13	PID Output Filter Time	0.00s~60.00s	0.00s	○
FA-15	Proportion Gain Kp2	0.0~100.0	20.0	○
FA-16	Integral Time Ti2	0.01s~10.00s	2.00s	○
FA-17	Differential Time Td2	0.000s~10.000s	0.000s	○
FA-18	PID Parameters Switching Condition	0: No switching 1: Switching through DI terminal 2: Automatic switching according to the deviation	0	○
FA-19	PID Parameters Switching Deviation 1	0.0%~FA-20	20.0%	○
FA-20	PID Parameters Switching Deviation 2	FA-19~100.0%	80.0%	○
FA-21	PID Initial Value	0.0%~100.0%	0.0%	○
FA-22	PID Initial Value Hold Time	0.00s~650.00s	0.00s	○
FA-23	Twice Output Deviation Positive Maximum Value	0.00%~100.00%	1.00%	○
FA-24	Twice Output Deviation Reverse Maximum	0.00%~100.00%	1.00%	○

	Value			
FA-25	PID Integral Property	Unit's digit: integral separation 0: Disabled 1: Enabled Ten's digit: whether stop integral after output the limit 0: Continue integral 1: Stop integral	0x00	○
FA-26	PID Feedback Lost Detection Value	0.0%: Don't judge feedback lost 0.1%~100.0%	0.0%	○
FA-27	PID Feedback Lost Detection Time	0.0s~20.0s	0.0s	○
FA-28	PID Feedback Lost Detection Starting Frequency	0.00Hz~max frequency	10.00Hz	○
FA-29	PID Stop Operation	0: No operation when stop 1: Operation when stop	0	○
FA-30	The Lower Limit Value of Feedback when PID Action	0.0%: No limit 0.1%~100.0%	0.0%	○
Fb Enhance Function Group				
Function Code	Parameter Name	Setting Range	Factory Default Value	Property
Fb-00	Jog Running Frequency	0.00Hz~max frequency	5.00Hz	○
Fb-01	Jog Acceleration Time	0.0s~6500.0s	Model dependent	○
Fb-02	Jog Deceleration Time	0.0s~6500.0s	Model dependent	○
Fb-03	Acceleration Time 2	0.0s~6500.0s	Model dependent	○
Fb-04	Deceleration Time 2	0.0s~6500.0s	Model dependent	○
Fb-05	Acceleration Time 3	0.0s~6500.0s	Model dependent	○
Fb-06	Deceleration Time 3	0.0s~6500.0s	Model dependent	○

Fb-07	Acceleration Time 4	0.0s~6500.0s	Model dependent	○
Fb-08	Deceleration Time 4	0.0s~6500.0s	Model dependent	○
Fb-09	Emergency Stop Time	0.0s~6500.0s	10.0s	○
Fb-10	Acceleration Time 1 and time 2 Switching Frequency Point	0.00Hz~max frequency	0.00Hz	○
Fb-11	Deceleration Time 1 and time 2 Switching Frequency Point	0.00Hz~max frequency	0.00Hz	○
Fb-12	Hopping Frequency 1	0.00Hz: frequency hopping point is invalid 0.01Hz~max frequency	0.00Hz	○
Fb-13	Hopping Frequency 2	0.00Hz: frequency hopping point is invalid 0.01Hz~max frequency	0.00Hz	○
Fb-14	Hopping Frequency Range	0.01Hz~max frequency	0.01Hz	○
Fb-15	Hopping Frequency Whether Valid in the Process of Acceleration and Deceleration	0: Disabled 1: Enabled	0	○
Fb-16	Frequency Detection Value (FDT1)	0.00Hz~max frequency	50.00Hz	○
Fb-17	Frequency Detection Lagged Value (FDT1)	0.0%~100.0% (FDT1 electrical level)	5.0%	○
Fb-18	Frequency Detection Value (FDT2)	0.00Hz~max frequency	50.00Hz	○
Fb-19	Frequency Detection Lagged Value (FDT2)	0.0%~100.0% (FDT2 electrical level)	5.0%	○

Fb-20	Frequency Reached Detection Amplitude	0.0%~100.0% (max frequency)	0.0%	○
Fb-21	Any Frequency Reaching Detection Value 1	0.00Hz~max frequency	50.00Hz	○
Fb-22	Any Frequency Reaching Detection Amplitude 1	0.0%~100.0% (max frequency)	0.0%	○
Fb-23	Any Frequency Reaching Detection Value 2	0.00Hz~max frequency	50.00Hz	○
Fb-24	Any Frequency Reaching Detection Amplitude 2	0.0%~100.0% (max frequency)	0.0%	○
Fb-25	Zero Current Detection Levels	0.0%~300.0% 100.0% corresponding rated motor current	5.0%	○
Fb-26	Zero Current Detection Delay Time	0.01s~600.00s	0.10s	○
Fb-27	Output Current Limit Exceed	0.0% (no detection) 0.1%~300.0% (rated motor current)	200.0%	○
Fb-28	Output Current Limit Exceed Detection Delay Time	0.00s~600.00s	0.00s	○
Fb-29	Any Current Reaching 1	0.0%~300.0% (rated motor current)	100.0%	○
Fb-30	Any Current Reaching 1 Amplitude	0.0%~300.0% (rated motor current)	0.0%	○
Fb-31	Any Current Reaching 2	0.0%~300.0% (rated motor current)	100.0%	○
Fb-32	Any Current Reaching 2 Amplitude	0.0%~300.0% (rated motor current)	0.0%	○
Fb-33	The Running Reached Time Setting	0.0Min~6500.0Min	0.0Min	○

Fb-34	Accumulative Power-on Reached Time Setting	0h~65000h	0h	○
Fb-35	Accumulative Running Reached Time Setting	0h~65000h	0h	○
Fb-36	Timing Function Selection	0: Disabled 1: Enabled	0	○
Fb-37	Timed Running Time Selection	0: Fb-38 setting 1: AI1 Analog input range corresponding to the Fb-38	0	○
Fb-38	Timed Running Function	0.0Min~65000.0Min	0.0Min	○
Fb-39	Module Temperature Reached	0°C~100°C	75°C	○
Fb-40	Lower Limit of AI1 Input Voltage Protection Value	0.00V~Fb-41	3.10V	○
Fb-41	Upper Limit of AI1 Input Voltage Protection Value	Fb-40~10.00V	6.80V	○
Fb-42	Wakeup Frequency	Dormancy frequency (Fb-44)~max frequency (F0-10)	0.00Hz	○
Fb-43	Wakeup Delay Time	0.0s~6500.0s	0.0s	○
Fb-44	Dormancy Frequency	0.00Hz~wakeup frequency (Fb-42)	0.00Hz	○
Fb-45	Dormancy Delay Time	0.0s~6500.0s	0.0s	○
Fb-48	Timing Braking Frequency	0.00Hz~50.00Hz	1.50Hz	○
Fb-49	Timing Braking Time	0.0s~60.0s	2.0s	○
Fb-50	Terminal Jog Priority	0: Disabled 1: Enabled	1	○
Fb-51	Swing Frequency	0: Relative to center frequency	0	○

	Setting Method	1: Relative to max frequency		
Fb-52	Swing Frequency Amplitude	0.0%~100.0%	0.0%	○
Fb-53	Jumping Frequency Amplitude	0.0%~50.0%	0.0%	○
Fb-54	Swing Frequency Cycle	0.1s~3000.0s	10.0s	○
Fb-55	Triangular Wave of Swing Frequency Rise Time	0.1%~100.0%	50.0%	○
Fb-56	Set Length	0m~65535m	1000m	○
Fb-57	Actual Length	0m~65535m	0m	○
Fb-58	Number of Pulse per Meter	0.1~6553.5	100.0	○
Fb-59	Set Count Value	1~65535	1000	○
Fb-60	Designated Count Value	1~65535	1000	○
FC Multi-reference and Simple PLC				
Function Code	Parameter Name	Setting Range	Factory Default Value	Property
FC-00	Multi-reference 0	-100.0%~100.0%	0.0%	○
FC-01	Multi-reference 1	-100.0%~100.0%	0.0%	○
FC-02	Multi-reference 2	-100.0%~100.0%	0.0%	○
FC-03	Multi-reference 3	-100.0%~100.0%	0.0%	○
FC-04	Multi-reference 4	-100.0%~100.0%	0.0%	○
FC-05	Multi-reference 5	-100.0%~100.0%	0.0%	○
FC-06	Multi-reference 6	-100.0%~100.0%	0.0%	○
FC-07	Multi-reference 7	-100.0%~100.0%	0.0%	○
FC-08	Multi-reference	-100.0%~100.0%	0.0%	○

	8			
FC-09	Multi-reference 9	-100.0%~100.0%	0.0%	○
FC-10	Multi-reference 10	-100.0%~100.0%	0.0%	○
FC-11	Multi-reference 11	-100.0%~100.0%	0.0%	○
FC-12	Multi-reference 12	-100.0%~100.0%	0.0%	○
FC-13	Multi-reference 13	-100.0%~100.0%	0.0%	○
FC-14	Multi-reference 14	-100.0%~100.0%	0.0%	○
FC-15	Multi-reference 15	-100.0%~100.0%	0.0%	○
FC-16	Simple PLC Run Mode	0: Stop when single run end 1: Keep the final value when single run end 2: Always circulation	0	○
FC-17	Simple PLC Power Failure Retentive Selection	Unit's digit: power failure retentive selection 0: Non-retentive at power failure 1: Retentive at power failure Ten's digit: stop retentive selection 0: Non-retentive at stop 1: Retentive at stop	0x00	○
FC-18	Run Time of Simple PLC Reference 0	0.0s (h)~6553.5s (h)	0.0s (h)	○
FC-19	Acceleration/Deceleration Time Selection of Simple PLC Reference 0	0~3	0	○
FC-20	Run Time of Simple PLC Reference 1	0.0s (h)~6553.5s (h)	0.0s (h)	○
FC-21	Acceleration/Deceleration Time Selection of Simple PLC Reference 1	0~3	0	○
FC-22	Run Time of Simple PLC Reference 2	0.0s (h)~6553.5s (h)	0.0s (h)	○

FC-23	Acceleration/Deceleration Time Selection of Simple PLC Reference 2	0~3	0	○
FC-24	Run Time of Simple PLC Reference 3	0.0s (h)~6553.5s (h)	0.0s (h)	○
FC-25	Acceleration/Deceleration Time Selection of Simple PLC Reference 3	0~3	0	○
FC-26	Run Time of Simple PLC Reference 4	0.0s (h)~6553.5s (h)	0.0s (h)	○
FC-27	Acceleration/Deceleration Time Selection of Simple PLC Reference 4	0~3	0	○
FC-28	Run Time of Simple PLC Reference 5	0.0s (h)~6553.5s (h)	0.0s (h)	○
FC-29	Acceleration/Deceleration Time Selection of Simple PLC Reference 5	0~3	0	○
FC-30	Run Time of Simple PLC Reference 6	0.0s (h)~6553.5s (h)	0.0s (h)	○
FC-31	Acceleration/Deceleration Time Selection of Simple PLC Reference 6	0~3	0	○
FC-32	Run Time of Simple PLC Reference 7	0.0s (h)~6553.5s (h)	0.0s (h)	○
FC-33	Acceleration/Deceleration Time Selection of Simple PLC Reference 7	0~3	0	○
FC-34	Run Time of Simple PLC Reference 8	0.0s (h)~6553.5s (h)	0.0s (h)	○

FC-35	Acceleration/Deceleration Time Selection of Simple PLC Reference 8	0~3	0	○
FC-36	Run Time of Simple PLC Reference 9	0.0s (h)~6553.5s (h)	0.0s (h)	○
FC-37	Acceleration/Deceleration Time Selection of Simple PLC Reference 9	0~3	0	○
FC-38	Run Time of Simple PLC Reference 10	0.0s (h)~6553.5s (h)	0.0s (h)	○
FC-39	Acceleration/Deceleration Time Selection of Simple PLC Reference 10	0~3	0	○
FC-40	Run Time of Simple PLC Reference 11	0.0s (h)~6553.5s (h)	0.0s (h)	○
FC-41	Acceleration/Deceleration Time Selection of Simple PLC Reference 11	0~3	0	○
FC-42	Run Time of Simple PLC Reference 12	0.0s (h)~6553.5s (h)	0.0s (h)	○
FC-43	Acceleration/Deceleration Time Selection of Simple PLC Reference 12	0~3	0	○
FC-44	Run Time of Simple PLC Reference 13	0.0s (h)~6553.5s (h)	0.0s (h)	○
FC-45	Acceleration/Deceleration Time Selection of Simple PLC Reference 13	0~3	0	○
FC-46	Run Time of Simple PLC Reference 14	0.0s (h)~6553.5s (h)	0.0s (h)	○

FC-47	Acceleration/Deceleration Time Selection of Simple PLC Reference 14	0~3	0	○
FC-48	Run Time of Simple PLC Reference 15	0.0s (h)~6553.5s (h)	0.0s (h)	○
FC-49	Acceleration/Deceleration Time Selection of Simple PLC Reference 15	0~3	0	○
FC-50	Simple PLC Run Time Unit	0: s 1: h	0	○
FC-51	Multi-reference 0 Setting Method	0: Coding FC-00 given 1: AI1 2: Reserved 3: Reserved 4: PULSE 5: PID 6: Preset frequency(F0-09)given, UP/DOWN can modify 7: Keypad potentiometer	0	○
FC-52	MS Speed Acceleration/Deceleration Time Selection Mode	0: Function code confirm 1: Terminal confirm	0	○
Fd MODBUS Communication				
Function Code	Parameter Name	Setting Range	Factory Default Value	Property
Fd-00	Baud Rate	0: 300BPS 1: 600BPS 2: 1200BPS 3: 2400BPS 4: 4800BPS 5: 9600BPS 6: 19200BPS 7: 38400BPS 8: 57600BPS 9: 115200BPS	5	○

Fd-01	Data Format	0: No verify (8-N-2) 1: Even verify (8-E-1) 2: Odd verify (8-O-1) 3: 8-N-1	0	○
Fd-02	Local Address	0: is broadcast address 1~247: slave address	1	○
Fd-03	Response Delay	0ms~20ms	2ms	○
Fd-04	Communication Timeout Time	0.0 (disabled) 0.1s~60.0s	0.0s	○
Fd-05	Data Transfer Format Selection	0: Non standard MODBUS protocol 1: Standard MODBUS protocol	1	○
Fd-06	Communication Read Current Resolution	0: 0.01A 1: 0.1A	0	○
FF User Parameters Group				
Function Code	Parameter Name	Setting Range	Factory Default Value	Property
FF-00	User Password	0~65535	0	○
FF-01	Parameter Initialization	0: No operation 1: Restore factory default setup value, exclude of motor parameter 2: Clear the record information 3: Backup user current parameters 4: Restore user current parameters	0	◎
FF-03	Function Code Display Selection	Unit's digit: 0: Not display A group 1: Display A group Ten's digit: 0: Not display b group 1: Display b group	0x11	○
FF-04	Function Code Modify Property	0: Can modify 1: Can't modify	0	○
FF-05	Fast Debugging Setting	Unit's digit: user custom parameter group display selection 0: Not display 1: Display Ten's digit: user change parameter group display selection 0: Not display	0x10	○

		1: Display		
FF-06	Product Code	0~65535	Factory Setting	●
FF-07	Software Versioning	1.00~10.00	Factory Setting	●
FF-08	Inverter Model		Factory Setting	●
FF-09	Date of Production (Year/Month)	0~9999	Factory Setting	●
FF-10	Date of Production (Date)	0~31	Factory Setting	●
FF-11	Inverter Module Radiator Temperature	0°C~120°C	0	●
FF-12	Reserved		0	●
FF-13	Accumulative Power Consumption	0°C~65535°C	0°C	●
FF-14	Accumulative Running Time	0h~65535h	0h	●
FF-15	Accumulative Power-on Time	0h~65535h	0h	●
FF-16	Time Lock Password	0h~65535h	0h	○
FF-17	Time Lock Time setting	0h~65535h	0h	○
FF-18	Time Lock Elapsed Time	0h~65535h	0h	●
FP Manufacturer parameter group				
A0 Motor 1 Torque Control				
Function Code	Parameter Name	Setting Range	Factory Default Value	Property
A0-00	Speed/Torque Control Mode Selection	0: Speed control 1: Torque control	0	◎
A0-01	Torque Setting Source Selection under the Torque Control Mode	0: Digital setting (A0-02) 1: AI1 2: Reserved 3: Reserved 4: PULSE	0	◎

		5: Communication setting 6: Reserved 7: Reserved 8: Keypad Potentiometer (the full scale of option 1~7 corresponding digital setting of A0-02)		
A0-02	Torque Digital Setting under the Torque Control Mode	-200.0%~2000%	100.0%	○

A0-03	Max Frequency Source Selection under the Torque Control Forward	0: Digital setting (A0-04) 1: AI1 2: Reserved 3: Reserved 4: PULSE 5: Communication setting 6: Keypad potentiometer	0	◎
A0-04	Max Frequency Digital Setting under the Torque Control Forward	0.00Hz~max frequency	50.00Hz	○
A0-05	Max Frequency Source Selection under the Torque Control Reverse	0: Digital setting (A0-06) 1: AI1 2: Reserved 3: Reserved 4: PULSE 5: Communication setting 6: Keypad potentiometer	0	◎
A0-06	Max Frequency Digital Setting under the Torque Control Reverse	0.00Hz~max frequency	50.00Hz	○
A0-07	Torque Control Acceleration Time	0.00s~650.00s	0.00s	○
A0-08	Torque Control deceleration Time	0.00s~650.00s	0.00s	○
A0-09	Starting Torque Setting	0.0%~100.0%	10.0%	◎
A0-10	Excitation Current Coefficient	20.0%~150.0%	100.0%	◎

	under the Torque Control (only effective to SVC)			
A0-11	Low Frequency Torque Compensation Amount	0.0%~50.0%	0.0%	○

A0-12	Low Frequency Torque Compensation Frequency Upper Limit	0.00Hz~Max frequency	10.00Hz	○
A0-13	High Frequency Torque Compensation Amount	0.0%~50.0%	3.0%	○
A0-14	High Frequency Torque Compensation Frequency Lower Limit	0.00Hz~Max frequency	25.00Hz	○
A0-15	Rotational Inertia Compensation Reference	0: Internal frequency 1: Feedforward frequency variation 2: Feedforward frequency	1	◎
A0-16	Feedforward Frequency Source Selection	0: AI1 1: Reserved 2: Reserved 3: PULSE 4: Communication setting	0	◎
A0-17	Rotational Inertia Compensation Coefficient	0.00~10.00	0.00	○
A0-18	Rotational Inertia Compensation Upper Limit	0.0%~50.0%	5.0%	○
A0-19	Rotational Inertia Compensation Starting	0.00Hz~max frequency	10.00Hz	○

	Frequency			
A0-20	Lowest Resolution Frequency (only effective to SVC)	0.00: Not limit 0.01Hz~2.00Hz	1.00Hz	○
A0-21	Disconnection Detection Time	0.0: Disconnection is invalid 0.1~60.0s	0.0	○

A1 Optimize Control Parameter				
Function Code	Parameter Name	Setting Range	Factory Default Value	Property
A1-00	Carrier Frequency	0.5kHz~16.0kHz	Model dependent	○
A1-01	Carrier Frequency Adjustment with the Temperature	0: No 1: Yes	1	○
A1-02	DPWM Switching Frequency Upper Limit	0.00Hz~15.00Hz	12.00Hz	○
A1-03	PWM Modulation Mode	LED unit's digit: 0: Asynchronous modulation 1: Synchronous modulation LED ten's digit: 0: Two phase and three phase modulation 1: Three phase modulation	0x00	◎
A1-04	Dead Zone Compensation Mode Selection	0: Without compensation 1: Compensation 1 2: Compensation 2	1	○
A1-05	Random PWM Depth	0: Random PWM invalid 1~10: PWM carrier frequency random depth	0	○
A1-06	Rapid Current Limiting Enable	0: Disable 1: Enable	1	○
A1-07	Current Detection Compensation	0~100	5	○

A1-08	SVC Optimize Mode Selection	0: Optimize 0 1: Optimize 1 2: Optimize 2	1	☉
A1-09	Dead Zone Time Adjustment	100%~200%	150%	☉
A1-10	Droop Control	0.00Hz~10.00Hz	0.00Hz	○
A1-11	Cooling Fan Control	0: Fan operation in runtime 1: Fan is always running	0	☉

A1-12	Speed Identification Filter Depth	0~8	4	☉
A1-13	Low Frequency Carrier Limit Mode	0: Limit mode 1 1: Limit mode 2 2: Not Limit	0	○

b0 User Customize Function Code

Function Code	Parameter Name	Setting Range	Factory Default Value	Property
b0-00	User Code 0		F0-00	○
b0-01	User Code 1		F0-01	○
b0-02	User Code 2		F0-02	○
b0-03	User Code 3		F0-09	○
b0-04	User Code 4		F0-18	○
b0-05	User Code 5		F0-19	○
b0-06	User Code 6		F4-00	○
b0-07	User Code 7		F4-01	○
b0-08	User Code 8		F5-01	○
b0-09	User Code 9		F5-02	○
b0-10	User Code 10		F5-03	○
b0-11	User Code 11		F6-02	○
b0-12	User Code 12		F6-03	○
b0-13	User Code 13		FF-06	○
b0-14	User Code 14		FF-06	○
b0-15	User Code 15		FF-06	○

b0-16	User Code 16		FF-06	○
b0-17	User Code 17		FF-06	○
b0-18	User Code 18		FF-06	○
b0-19	User Code 19		FF-06	○
b0-20	User Code 20		FF-06	○
b0-21	User Code 21		FF-06	○
b0-22	User Code 22		FF-06	○
b0-23	User Code 23		FF-06	○
b0-24	User Code 24		FF-06	○
b0-25	User Code 25		FF-06	○
b0-26	User Code 26		FF-06	○
b0-27	User Code 27		FF-06	○
b0-28	User Code 28		FF-06	○
b0-29	User Code 29		FF-06	○
b0-30	User Code 30		FF-06	○
b0-31	User Code 31		FF-06	○
b1 Virtual IO				
Function Code	Parameter Name	Setting Range	Factory Default Value	Property
b1-00	Virtual VDI1 Terminal Function Selection	0~59	0	◎
b1-01	Virtual VDI2 Terminal Function Selection	0~59	0	◎
b1-02	Virtual VDI3 Terminal Function Selection	0~59	0	◎
b1-03	Virtual VDI4 Terminal Function Selection	0~59	0	◎
b1-04	Virtual VDI5 Terminal Function Selection	0~59	0	◎

b1-05	Virtual VDI Terminal State Setting Mode	<p>Unit's digit: virtual VDI1 0: By virtual VDOx state to decide VDI is valid or not 1: By code b1-06 setting VDI is valid or not</p> <p>Ten's digit: virtual VDI2, same as above</p> <p>Hundred's digit: virtual VDI3, same as above</p> <p>Thousand's digit: virtual VDI4, same as above</p> <p>Ten thousand's digit: virtual VDI5, same as above</p>	0x00000	⊙
b1-06	Virtual VDI Terminal state setting	<p>Unit's digit: virtual VDI1 0: Disabled 1: Enabled</p> <p>Ten's digit: virtual VDI2, same as above</p> <p>Hundred's digit: virtual VDI3, same as above</p> <p>Thousand's digit: virtual VDI4, same as above</p> <p>Ten thousand's digit: virtual VDI5, same as above</p>	0x00000	⊙
b1-07	Function Selection when AI1 Terminal as DI	0~59	0	⊙
b1-10	Effective Mode Selection when AI1 Terminal as DI	<p>0: High electrical level enable 1: Low electrical level enable</p>	0	⊙
b1-11	Virtual VDO1 Output Function Selection	<p>0: Short circuit with physical DIX internal 1~43: see the F6 group physical DO output selection</p>	0	○

b1-12	Virtual VDO2 Output Function Selection	0: Short circuit with physical DIX internal 1~43: see the F6 group physical DO output selection	0	○
b1-13	Virtual VDO3 Output Function Selection	0: Short circuit with physical DIX internal 1~43: see the F6 group physical DO output selection	0	○

b1-14	Virtual VDO4 Output Function Selection	0: Short circuit with physical DIX internal 1~43: see the F6 group physical DO output selection	0	○
b1-15	Virtual VDO5 Output Function Selection	0: Short circuit with physical DIX internal 1~43: see the F6 group physical DO output selection	0	○
b1-16	VDO1 Closing Delay	0.0s~3600.0s	0.0s	○
b1-17	VDO2 Closing Delay	0.0s~3600.0s	0.0s	○
b1-18	VDO3 Closing Delay	0.0s~3600.0s	0.0s	○
b1-19	VDO4 Closing Delay	0.0s~3600.0s	0.0s	○
b1-20	VDO5 Closing Delay	0.0s~3600.0s	0.0s	○
b1-21	VDO Output Terminal Effective State Selection	Unit's digit: VDO1 0: Positive logic 1: Anti-logic Ten's digit: VDO2, same as above Hundred's digit: VDO3, same as above Thousand's digit: VDO4, same as above Ten thousand's digit: reserved	0x00000	○
b1-22	VDO1 Disconnection Delay	0.0s~3600.0s	0.0s	○
b1-23	VDO2 Disconnection Delay	0.0s~3600.0s	0.0s	○
b1-24	VDO3 Disconnection	0.0s~3600.0s	0.0s	○

	Delay			
b1-25	VDO4 Disconnection Delay	0.0s~3600.0s	0.0s	○
b1-26	VDO5 Disconnection Delay	0.0s~3600.0s	0.0s	○

b2 AI Curve Setting				
Function Code	Parameter Name	Setting Range	Factory Default Value	Property
b2-00	AI Curve 4 Min Input	-10.00V~b2-02	0.00V	○
b2-01	Corresponding Setting of AI Curve 4 Min Input	-100.0%~+100.0%	0.0%	○
b2-02	AI Curve 4 Inflection Point 1 Input	b2-00~b2-04	3.00V	○
b2-03	Corresponding Setting of AI Curve 4 Inflection Point 1 Input	-100.0%~+100.0%	30.0%	○
b2-04	AI Curve 4 Inflection Point 2 Input	b2-00~b2-06	6.00V	○
b2-05	Corresponding Setting of AI Curve 4 Inflection Point 2 Input	-100.0%~+100.0%	60.0%	○
b2-06	AI Curve 4 Max Input	b2-06~+10.00V	10.00V	○
b2-07	Corresponding Setting of AI Curve 4 Max Input	-100.0%~+100.0%	100.0%	○
b2-08	AI Curve 5 Min Input	-10.00V~b2-10	-10.00V	○
b2-09	Corresponding Setting of AI Curve 5 Min Input	-100.0%~+100.0%	-100.0%	○

b2-10	AI Curve 5 Inflection Point 1 Input	b2-08~b2-12	-3.00V	○
b2-11	Corresponding Setting of AI Curve 5 Inflection Point 1 Input	-100.0%~+100.0%	-30.0%	○

b2-12	AI Curve 5 Inflection Point 2 Input	b2-10~b2-14	3.00V	○
b2-13	Corresponding Setting of AI Curve 5 Inflection Point 2 Input	-100.0%~+100.0%	30.0%	○
b2-14	AI Curve 5 Max Input	b2-12~+10.00V	10.00V	○
b2-15	Corresponding Setting of AI Curve 5 Max Input	-100.0%~+100.0%	100.0%	○
b2-16	AI1 Setting Jump Point	-100.0%~100.0%	0.0%	○
b2-17	AI1 Setting Jump Range	0.0%~100.0%	0.5%	○
b2-18	AI2 Setting Jump Point	-100.0%~100.0%	0.0%	○
b2-19	AI2 Setting Jump Range	0.0%~100.0%	0.5%	○

b3 AIAO Correction

Function Code	Parameter Name	Setting Range	Factory Default Value	Property
b3-00	AI1 Measured Voltage 1	0.500V~4.000V	Factory Correction	○
b3-01	AI1 Displayed Voltage 1	0.500V~4.000V	Factory Correction	○
b3-02	AI1 Measured Voltage 2	6.000V~9.999V	Factory Correction	○
b3-03	AI1 Displayed Voltage 2	6.000V~9.999V	Factory Correction	○
b3-12	AO1 Target Voltage 1	0.500V~4.000V	Factory Correction	○

b3-13	AO1 Measured Voltage 1	0.500V~4.000V	Factory Correction	○
b3-14	AO1 Target Voltage 2	6.000V~9.999V	Factory Correction	○
b3-15	AO1 Measured Voltage 2	6.000V~9.999V	Factory Correction	○

U0 Basic Monitoring Parameters				
Function Code	Parameter Name	Setting Range	Factory Default Value	Property
U0-00	Running Frequency (Hz)		0.01Hz	●
U0-01	Set Frequency (Hz)		0.01Hz	●
U0-02	Bus Voltage (V)		0.1V	●
U0-03	Output Voltage (V)		1V	●
U0-04	Output Current (A)		0.01A	●
U0-05	Output Power (kW)		0.1kW	●
U0-06	Output Torque (%)		0.1%	●
U0-07	DI Input State		1	●
U0-08	DO Input State		1	●
U0-09	AI1 Voltage (V)		0.01V	●
U0-10	Reserved			●
U0-11	Reserved			●
U0-12	Count Value		1	●
U0-13	Length Value		1	●
U0-14	Load Speed Display		1	●
U0-15	PID Setting		1	●
U0-16	PID Feedback		1	●
U0-17	PLC Stage		1	●
U0-18	Input PULSE		0.01 kHz	●

	Frequency (kHz)			
U0-19	Feedback Speed (0.1Hz)		0.1Hz	●
U0-20	Setting Torque		0.1%	●
U0-21	AI1 Voltage before Correction		0.001V	●
U0-22	Reserved			●
U0-23	Reserved			●
U0-24	Line Speed		1m/Min	●
U0-25	Current Power on Time		1Min	●
U0-26	Current Running Time		0.1Min	●
U0-27	Input PULSE Frequency		1Hz	●
U0-28	Communication Setting Value		0.01%	●
U0-29	Encode Feedback Speed		0.01Hz	●
U0-30	Main Frequency A display		0.01Hz	●
U0-31	Auxiliary Frequency B Display		0.01Hz	●
U0-32	View Any Memory Address Value		1	●
U0-33	Reserved			●
U0-34	Reserved			●
U0-35	Surplus Running Time		0.1Min	●
U0-36	Reserved		1	●
U0-37	Power Factor Angle		0.1°	●
U0-38	Reserved			●
U0-39	Vf Separation Target Voltage		1V	●

U0-40	VF Separation Output Voltage		1V	●
U0-41	Visual Display DI Input State		1	●
U0-42	Visual Display DO Input State		1	●

U0-43	Visual Display DI Function State 1 (Function 01~40)		1	●
U0-44	Visual Display DI Function State 2 (Function 41~80)		1	●
U0-45	Current Fault State		1	●
U0-46	Torque Compensation Amount		0.1%	●

Chapter 6 Parameter Description

F0 Basic Function

F0-00	Motor Control Mode	0: V/F control 1: SVC	0	◎
-------	--------------------	--------------------------	---	---

0: V/F control mode:

Suitable for load demand is not high, or a frequency inverter drive multi-motors application, such as fan and pump load.

1: SVC

Refers to the open loop vector control, suitable for the usual higher performance control occasions, one frequency inverter can only drive a motor. Such as machine tools, centrifuge, wire drawing machine, injection machine and the load.

F0-01	Running Command Source Selection	0: Control panel command source (L/R OFF) 1: Terminal command source (L/R ON) 2: Communication command source (L/R flashes)	0	○
-------	----------------------------------	---	---	---

Select inverter run command source:

Inverter run command include: start, stop, forward run, reverse run, jog, etc.

0: Control panel command source (L/R OFF)

Key" RUN, JOG/REV, STOP/RESET" on control panel to realize command control.

1: Terminal command source (L/R ON)

Through multi-function input terminal to realize command control.

2: Communication command source (L/R flashes)

Operation command as setup via HOST PC via communication mode, when select this option, default is Modbus communication (standard).

F0-02	Main Frequency Source A Selection	0: Digital setting(F0-09, UP/DOWN can be modified, no memory when power failure) 1: Digital setting(F0-09, UP/DOWN can be modified, memory when power failure) 2: AI1 3: Reserved 4: Reserved 5: PULSE setting 6: MS reference 7: Simple PLC 8: PID 9: Communication setting 10: Keypad potentiometer	10	◎
-------	-----------------------------------	---	----	---

Select inverter input channel of in main given frequency, total 11 kinds of main given frequency channel.

0: Digital setting(no memory when power failure)

Set the initial value of frequency F0-09 (preset frequency) value. Can bring through a keyboard keys ▲ and ▼ (or multi-function input terminal of the UP/DOWN) to change the set frequency value of the frequency inverter.

When frequency inverter power on again after power off, set frequency value revert to F0-09 (digital setting preset frequency) value.

1: Digital setting(memory when power failure)

Set the initial value of frequency F0-09 (preset frequency) value. Can bring through a keyboard keys ▲ and ▼ (or multi-function input terminal of the UP/DOWN) to change the set frequency value of the frequency inverter.

When frequency inverter power on again after power off, set frequency is the set frequency that power off in last time, can bring through a keyboard keys ▲ and ▼ (or multi-function input terminal of the UP/DOWN) correction by memory.

What need reminds is, F0-17 is "digital set frequency stop memory selection", F0-17 is used to select the frequency correction is memory or reset when inverter stop. F0-17 is associated with downtime, not related to the power lost memory, should pay attention to in the application.

2: AI1

Refers to the frequency by the analog input terminal to determine. VD120 control panel provides one analog input terminal (AI1).

Among them, AI1 for -10V~10V voltage input, can also be used to 0mA/4mA~20mA current input, select by AI1 jump line on control panel.

AI1 input voltage values of the corresponding relationship with the target frequency, users are free to selection. VD120 provide 5 set of corresponding relation curve, 3 groups of curve for linear relationship (2 points correspondence), 2 set of curves for the corresponding relation of 4 point any curve, user can be set by F5 group function code.

Function code F5-20 used to set the AI1 analog input, select 5 groups respectively in a curve, and 5 curve's corresponding relation please refer to the F5 group function code.

5: PULSE setting (HDI1)

Frequency is given by terminal pulse setting.

Pulse signal given specifications: voltage range 9V~30V and frequency range of 0kHz~100kHz.

Pulse can only be given from multi-function input terminal DI5/HDI1 input, then need the set DI5/HDI1 terminal function for 23.

DI5/HDI1 terminal input pulse frequency and the corresponding set of relations, through the F5-37~F5-40 setting, the corresponding relations of 2 points of straight line, the corresponding set of input pulses 100.0%, is refers to the relative maximum frequency F0-10 percentage.

6: MS reference

Select MS reference operation mode, need through the digital quantity input DI terminal state of different combination, corresponding to different set frequency values. VD120 can set up more than 4 MS reference terminal, the 16 kinds of state of 4 terminals by FC group function code corresponding to the arbitrary 16 "MS reference", "MS reference" is relatively maximum frequency F0-10 percentage.

When DI digital quantity input terminals as MS reference terminal function, need to do accordingly setting in the F5 group, specific content please refer to the related function parameters of F5 group.

7: Simple PLC

When frequency source is simple PLC, the operation frequency source of inverter can be in 1~16 arbitrary frequency switching between operation instruction, holding time 1~16 frequency instructions, their respective deceleration time can also be user settings, specific content reference FC group of related instructions.

8: PID

The selection process of PID control output as the running frequency. Commonly used in the scene of the closed loop technology, such as constant pressure closed loop control, constant tension closed-loop, etc.

Application of PID as frequency source, you need to set up FA group (PID function parameter group)

related parameters.

9: Communication setting

Refers to the main frequency source by the HC is given by way of communication.

VD120 support Modbus communication mode.

Modbus communication is standard, the other two kinds of communication card is optional, the user to select according to need, and need to set the parameters F0-23 (communication extension card type) correctly.

10: Keypad potentiometer

Frequency source is given by keypad potentiometer.

F0-03	Main Frequency A Gain	0.000~10.000	1.000	○
-------	--------------------------	--------------	-------	---

The actual value of main frequency source A=F0-02*F0-03.

F0-04	Auxiliary Frequency Source B Selection	Same as F0-02 (Main Frequency Source A Selection)	0	◎
-------	---	--	---	---

Auxiliary frequency source as a separate frequency given channel (that is, the switching frequency source selection for A to B), its usage same as the main frequency source A, the method of use can reference the related description of F0-02.

When auxiliary frequency source used as superposition of given (i.e. frequency source selection for A+B, A to A+B switch or B to A+B switch), need to pay attention to:

- 1) When the auxiliary frequency source for digital given, preset frequency (F0-09) doesn't work, the user through the keyboard ▲, ▼ key (or the UP/DOWN of multi-function input terminal) for the adjustment of the frequency.
- 2) When the auxiliary frequency source for analog input given (AI1, AI2) or pulse input given, input 100% of the set corresponding auxiliary frequency source range, can be set through by the F0-06 and F0-07.
- 3) When frequency source for pulse input given, is similar to analog given.

Tip: auxiliary frequency source selection B and main frequency source A selection, can't be set to the same channel, namely F0-02 and F0-04 can't set to the same value, otherwise easy to cause confusion.

F0-05	Frequency Source Superposition Selection	Unit's digit: frequency source selection 0: Main frequency source A 1: Main auxiliary operation result (operational relationship is determined by ten bits) 2: Main frequency source A switching with auxiliary frequency source B 3: Main frequency source A switching with main and auxiliary operation result Ten's digit: frequency source main and auxiliary operation relationship 0: Main + auxiliary 1: Main – auxiliary 2: Max value of the two 3: Min value of the two	0x00	○
-------	--	---	------	---

Through this parameter selection frequency given channel. Through the compound of main frequency source A and auxiliary frequency source B to achieve frequency given.

Unit's digit: frequency source selection

0: main frequency source A

Main frequency A as the target frequency.

1: Main and auxiliary operation result

Main and auxiliary operation result as the target frequency, the main and auxiliary operation relationship please see the “ten’s digit” instruction of this function code.

2: The main frequency source A switch auxiliary frequency source B

When multi-function input terminal function 14 (frequency source switch) is invalid, main frequency A as the target frequency.

When multi-function input terminal function 14 (frequency source switch) is valid, auxiliary frequency B as the target frequency.

3: The main frequency source A switch main and auxiliary operation result

When multi-function input terminal function 14 (frequency source switch) is invalid, main frequency A as the target frequency.

When multi-function input terminal function 14 (frequency source switch) is valid, main and auxiliary operation result as the target frequency.

4: Auxiliary frequency source B switch main and auxiliary operation result

When multi-function input terminal function 14 (frequency source switch) is invalid, auxiliary frequency B as the target frequency.

When multi-function input terminal function 14 (frequency source switch) is valid, main and auxiliary operation result as the target frequency.

Ten’s digit: frequency source main and auxiliary operation relations

0: main frequency source A + auxiliary frequency source B

The sum of main frequency A and auxiliary frequency B as the target frequency. To realize frequency superposition of given function.

1: The main frequency source A – auxiliary frequency source B

The main frequency A minus auxiliary frequency B difference as the target frequency.

2: MAX (main frequency source A, auxiliary frequency source B)

Take the maximum absolute of main frequency A and auxiliary frequency B as the target frequency.

3: Min (main frequency source A, auxiliary frequency source B)

Take the minimum absolute of main frequency A and auxiliary frequency B as the target frequency.

In addition, when the frequency source selection for the main and auxiliary operation, can be set the offset frequency through F0-08, superimposed offset frequency on the main and auxiliary operation result in a flexible response to all kinds of needs.

F0-06	Auxiliary Frequency Source B Range Reference Selection when Superimposed	1: Relative to the max frequency 2: Relative to frequency source A	0	○
F0-07	Auxiliary Frequency Source B Range when Superimposed	0%~150%	100%	○

When selecting frequency source for the “frequency superposition” (F0-05 set to 1, 3 or 4), these two parameters used to determine the adjusting range of auxiliary frequency source.

F0-06 is used to determine the relative object of the scope of the auxiliary frequency source, can select to the relative to the maximum frequency, can also be relative to the main frequency source A, if the selection is relative to the main frequency source, the scope of the auxiliary frequency source will change as main frequency source A change.

F0-08	Auxiliary Frequency Source Offset Frequency when Superimposed	0.00Hz~max frequency F0-10	0.00Hz	○
-------	---	----------------------------	--------	---

This function code is only valid at the time of frequency source selection of the main and auxiliary operation.

When the frequency source is main and auxiliary operation, F0-08 as offset frequency, and with main and auxiliary operation result superimposed as the final frequency set value, make the frequency set can be more flexible.

F0-09	Digital Setting Frequency	0.00Hz~max frequency (F0-10)	50.00Hz	○
-------	---------------------------	------------------------------	---------	---

When frequency source selection as “digital setting” or “terminal UP/DOWN”, the function code value is the initial value of frequency digital setting of inverter.

F0-10	Max Frequency	50.00Hz~600.00Hz	50.00Hz	◎
-------	---------------	------------------	---------	---

VD120 analog input, pulse input (HDI1), multi-reference etc., 100% of their relative to F0-10 scaling as frequency source.

F0-11	Frequency Upper Limit Source	0: F0-12 setting 1: AI1 2: Reserved 3: Reserved 4: PULSE setting 5: Communication setting	0	◎
-------	------------------------------	--	---	---

Define the frequency upper limit source. Frequency upper limit can be from digital setting (F0-12), also from the analog input channel. When use analog input set the frequency upper limit, 100% of the analog input set corresponding F0-12.

For example at the scene of the winding control using torque control mode, in order to avoid material break appear “galloping” phenomenon, can use analog set the frequency upper limit, when inverter running to the frequency upper limit value, the frequency inverter in frequency upper limit running.

F0-12	Frequency Upper Limit	Frequency lower limit F0-14~max frequency F0-10	50.00Hz	○
F0-13	Frequency Upper Limit Offset	0.00Hz~max frequency F0-10	0.00Hz	○

When the frequency upper limit for analog or PULSE setting, F0-13 as the offset of set value, the offset frequency and F0-11 set frequency upper limit value superposition, as the final frequency upper limit set value.

F0-14	Frequency Lower Limit	0.00Hz~frequency upper limit F0-12	0.00Hz	○
-------	-----------------------	------------------------------------	--------	---

When frequency instructions is lower than the frequency lower limit of F0-14 set, inverter can stop, running at frequency lower limit or zero speed, what running mode can be through the F1-17 (set frequency is lower than the frequency lower limit running mode) set.

F0-15	Frequency Command Resolution	2: 0.01Hz	2	●
-------	------------------------------	-----------	---	---

The parameter used to determine all the resolution of the function code associated with the frequency.

When frequency resolution is 0.01Hz, the maximum output frequency of VD120 is 600.00Hz.

F0-16	Frequency Command UP/DOWN Reference in Running	0: Running frequency 1: Set frequency	0	⊙
-------	--	--	---	---

This parameter is only valid when frequency source for the digital setting.

Used to determine the keypad key ▲, ▼ or terminal UP/DOWN action, adopt what way correction set frequency, namely the target frequency is increase or decrease based on the running frequency, or increase or decrease base on the set frequency.

The difference between two kinds of settings, evident when inverter in the deceleration process, namely if the running frequency of inverter is different with the set frequency, the parameter different selection difference is very big.

F0-17	Digital Setting Frequency Memory Selection when Stop	0: No memory 1: Memory	0	○
-------	--	---------------------------	---	---

The function is only valid when frequency source for the digital setting.

“No memory” refers to the frequency inverter after downtime, digital set frequency values revert to F0-09 (preset frequency) value, keypad key ▲, ▼ or terminal UP/DOWN to correct the frequency is zero.

“Memory” refers to the frequency inverter after downtime, digital set frequency keep set frequency for the last moment downtime, keypad key ▲, ▼ or terminal UP/DOWN to correct the frequency is remain valid.

F0-18	Acceleration Time 1	0.00s~65000s	Model dependent	○
F0-19	Deceleration Time 1	0.00s~65000s	Model dependent	○

Acceleration time refers to the time required that frequency inverter from zero frequency acceleration to acceleration/deceleration reference frequency (F0-21), as show in figure 6-1 in the t1.

Deceleration time refers to the time required that frequency inverter from deceleration/deceleration reference frequency (F0-21) deceleration to zero frequency, as show in figure 6-1 in the t2.

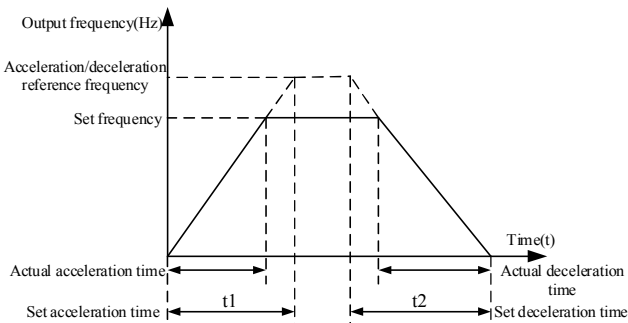

Fig 6-1 Acceleration/deceleration time diagram

VD120 provide 4 groups acceleration/deceleration time, user can use digital input terminal DI switch selection, 4 groups of acceleration/deceleration time through following function code to set:

The first group: F0-18, F0-19;

The second group: Fb-03, Fb-04;

The third group: Fb-05, Fb-06;

The forth group: Fb-07, Fb-08;

F0-20	Acceleration/Deceleration Time Unit	0: 1s 1: 0.1s 2: 0.01s	1	⊙
-------	-------------------------------------	------------------------------	---	---

To meet the need of all kinds of scene, VD120 provides three kinds of acceleration/deceleration time units, is 1 seconds, 0.1 seconds and 0.01 seconds respectively.

Note: modify the function parameters, 4 groups of acceleration/deceleration time display the decimal digits will change, the corresponding acceleration/deceleration time also change, should pay attention to in the process of application.

F0-21	Acceleration and Deceleration Time Reference Frequency	0: Max frequency (F0-10) 1: Setting frequency 2: 100Hz	0	⊙
-------	--	--	---	---

Acceleration/deceleration time, refers to the acceleration/deceleration time from frequency zero to F0-21 set frequency, figure 6-1 is acceleration/deceleration time diagram.

When F0-21 select for 1, the acceleration/deceleration time is associated with set frequency, if set frequency change frequently, the acceleration of motor is change, need to pay attention to in applications.

F0-22	Command Source Bound Frequency Source	Unit's digit: Operation panel command binding frequency source selection 0: No binding 1: Digital setting frequency 2: AI1 3: Reserved 4: Reserved 5: PULSE setting 6: MS reference 7: Simple PLC 8: PID 9: Communication setting Ten's digit: terminal command binding frequency source selection Hundred's digit: communication command binding frequency source selection Thousand's digit: Automatic operation command binding frequency source selection	0x0000	○
-------	---------------------------------------	--	--------	---

Define the bound combination between three run command channel and nine kinds of frequency given channel, convenient to realize synchronous switch.

The meaning of the above frequency for given channel is same with the main frequency source A selection F0-02, please see the description of F0-02 function code.

The different run command channels can be bound to the same frequency given channel.

When the command source has bundled frequency source, during the effective period of this command source, the set frequency source of F0-02~F0-07 is no longer work.

F0-23	Communication Protocol Selection	0: Modbus	0	●
-------	----------------------------------	-----------	---	---

See chapter 9 communication protocol description.

F1 Start/Stop Control Group

F1-00	Start Mode	0: Direct start 1: Speed tracking restart 2: Pre excitation start (AC asynchronous)	0	○
-------	------------	--	---	---

0: direct start

If start dc braking time is set to 0, the frequency inverter starting run from start frequency.

If start dc braking time is not zero, the dc braking first, and then starting run from start frequency. Apply the occasion that have small inertia load, motor may be turning at starting.

1: speed tracking restart

Frequency inverter judgment for motor speed and direction first, and to track the frequency of the motor starting, smooth and no impact on the implementation of the rotating motor startup. Applicable to large inertia of the instantaneous power failure to start again. In order to guarantee the performance of speed tracking restart, motor F2 group parameters should be accurately set.

2: asynchronous motor pre-excitation start

Only valid for asynchronous motor, used to build magnetic field in motor running before.

Pre excitation current, pre exciting time see the description of function code F1-03, F1-04.

If pre excitation time is set to 0, the frequency inverter to cancel the excitation process, from start frequency to start. Pre excitation time is not zero, the first pre excitation restart, can improve the motor dynamic response performance.

F1-01	Starting Frequency	0.00Hz~10.00Hz	0.50Hz	○
F1-02	Startup Frequency Holding Time	0.00s~100.0s	0.0s	◎

In order to ensure the motor torque of startup, please set the right start frequency. In order to make fully establish flux when the motor start, need to start the frequency to keep a certain time.

Start frequency F1-01 without being limited by the lower limit frequency. But when goal setting frequency is less than the start frequency, frequency inverter is not started in the standby state.

In the process of positive & negative switching, start frequency holding time doesn't work.

Start frequency holding time is not included in the acceleration / deceleration time, but in the simple PLC running time.

For example 1:

F0-02=0 Frequency source is digital given
 F0-09=2.00Hz Digital set frequency is 2.00Hz
 F1-01=5.00Hz Start frequency is 5.00Hz
 F1-02=2.0s Start frequency holding time is 2.0s

At this point, the inverter will be in standby state, the inverter output frequency is 0.00Hz.

For example 2:

F0-02=0 Frequency source is digital given
 F0-09=10.00Hz Digital set frequency is 10.00Hz
 F1-01=5.00Hz Start frequency is 5.00Hz
 F1-02=2.0s Start frequency holding time is 2.0s

At this point, the inverter accelerate to 5.00Hz for 2.0s, then accelerated to given frequency 10.00Hz.

F1-03	Starting DC Braking Current/ Pre-excitation Current	0%~100%	0%	☉
F1-04	Starting DC Braking Time / Pre-excitation Time	0.0s~100.0s	0.0s	☉

Start the dc braking, generally used to make the running motor restart after stop. Pre excitation is used to make the asynchronous motor build magnetic field first then restart, improve the response speed.

Start the dc braking is only valid for starting mode is direct startup. The inverter dc braking will according to the first startup dc braking current setting, start running again after start the dc braking time. If set dc braking time is 0, then directly start without dc braking. The greater the dc braking current, the bigger the braking force.

If the starting mode is asynchronous motor pre-excitation start, the inverter according to the first set of pre excitation current build magnetic field beforehand, start running again after the pre excitation time setting. If set pre excitation time is 0, then directly start without dc braking.

Start dc braking current/pre excitation current, is relative to the percentage of the frequency inverter rated current.

F1-05	Speed Tracking Mode	0: Starting from the stop frequency 1: Starting from zero speed 2: Starting from the maximum frequency	0	☉
-------	---------------------	--	---	---

In order to complete the speed tracking process, selection the mode of inverter track motor speed through this function code:

0: Tracking down from the frequency of the power failure, usually selection this way.

1: Starting from zero frequency tracking up, in the case of power failure for a long time to start to use.

2: Tracking down from the maximum frequency, the use of general power load.

F1-06	Speed Tracking Speed	1~100	20	○
-------	----------------------	-------	----	---

When the speed tracking is started, the speed of speed tracking is selected.

The bigger the parameter, the faster the speed tracking. But too large can cause speed tracking effect is reliable

F1-07	Speed Tracking Current	100%~150%	125%	☉
-------	------------------------	-----------	------	---

The size of the current speed tracking search.

F1-08	Stop Mode	0: Decelerate to stop 1: Coast to stop	0	○
-------	-----------	---	---	---

0: decelerate to stop

After stop command effective, inverter reduced the output frequency according to deceleration time, frequency downtime after drop to zero.

1: Coast to stop

After stop command effective, inverter stop output immediately, the motor coast to stop according to the mechanical inertia.

F1-09	Initial Frequency of Stop DC Braking	0.00Hz~max frequency	0.00Hz	○
F1-10	Waiting Time of Stop DC Braking	0.0s~100.0s	0.0s	○
F1-11	Stop DC Braking Current	0%~100%	0%	○

F1-12	Stop DC Braking Time	0.0s~100.0s	0.0s	○
-------	----------------------	-------------	------	---

Initial frequency of stop dc braking: in the process of deceleration, when reduce the running frequency to the frequency, began to dc braking process.

Waiting time of stop dc braking: when reduce the running frequency to initial frequency of stop dc braking, frequency inverter output to stop for a period of time, and then began to dc braking process. Used to prevent began to dc braking may be caused overcurrent such faults at high speed.

Stop dc braking current: refers to the output current when dc braking, relative to the percentage of the motor rated current. The greater the value is, the stronger the dc braking effect is, but the greater the fever of motor and frequency inverter is.

Stop dc braking time: refers to the dc braking holding time. The dc baking process has been cancelled when this value is 0.

Stop dc braking process as shown in figure 6-2.

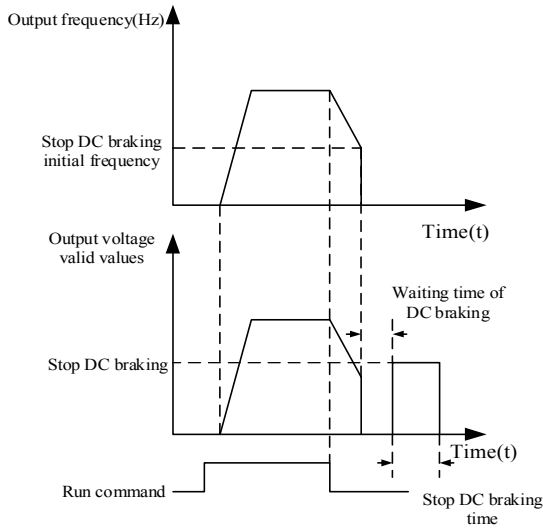

Fig 6-2 Stop dc braking diagram

F1-13	Stop Frequency	0.00Hz~max frequency	0.50	○
F1-14	Stop Frequency Holding Time	0.0s~60.0s	0.0s	○

When inverter output frequency slowed to F1-13 (stop frequency), keep F1-14 (stop frequency holding time), the inverter stop (blockade output), motor inertial parking.

F1-15	Restart Selection Upon Power Failure	0: Enabled 1: Disabled	0	○
F1-16	Waiting Time of Restart Upon Power Failure	0.0s~60.0s	0.0s	○

Used to run command source is terminal control.

Enabled: when terminal run command has maintained, inverter will autostart after power on self-inspection normal and delay the time of F1-16.

Disabled: when terminal run command has maintained, inverter will not autostart after power on self-inspection normal, only start when run command given again after disconnecting.

F1-17	Operation Mode of Set Frequency is Lower than the Frequency Lower Limit	0: Running with frequency lower limit 1: Stop 2: Zero speed running	0	<input type="radio"/>
-------	---	---	---	-----------------------

When set frequency is lower than the frequency lower limit, the running state of inverter can be through the parameter selection. VD120 provide three kinds of running mode, meet various application requirements.

F1-18	Start Selection of Set Frequency is Lower than the Start Frequency	0: Don't start 1: Zero speed running	1	<input checked="" type="radio"/>
-------	--	---	---	----------------------------------

When set frequency is lower than the start frequency, the running state of inverter can be through the parameter selection. VD120 provide two kinds of running mode, meet various application requirements.

F1-19	Run Direction	0: Same direction 1: Opposite direction	0	<input type="radio"/>
-------	---------------	--	---	-----------------------

By changing the function code, can not change the motor wiring and implement the purpose of change motor rotation, its effect is equivalent to adjust motor (U, V, W) any two lines for motor direction of rotation transformation.

Tip: after initialization parameter will restore the original state of the motor running direction. For the occasion that forbidden to change the motor rotation after system debugging good should be used with caution.

F1-20	Reverse Control Enable	0: Allow reverse 1: Prohibit reverse	0	<input type="radio"/>
-------	------------------------	---	---	-----------------------

Through the parameter set inverter is allowed to run or not in reverse state, in the case of not allow motor reversal, need to set F1-20=1.

F1-21	FWD/REV Rotation Dead-zone Time	0.0s~3000.0s	0.0s	<input type="radio"/>
-------	---------------------------------	--------------	------	-----------------------

In the process of set the frequency inverter positive & negative transition, output transition time at 0Hz, as shown in figure 6-3.

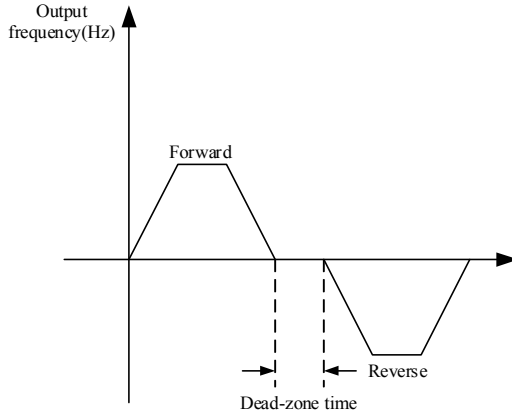

Fig 6-3 Schematic diagram of forward/reverse dead-zoen time

F1-22	Dynamic Braking Enable	0: Disabled 1: Enabled	0	<input type="radio"/>
F1-23	Braking Usage Rate	0%~100%	100%	<input type="radio"/>

Only be effective for the inverter that built-in braking unit.

Used to adjust the duty ratio of braking unit, the higher the usage rate is, the higher the duty ratio of braking unit is, the stronger the braking effect is, the bigger the inverter bus voltage fluctuation in braking process is.

F1-24	Over-excitation Effective Range	0: The whole is valid 1: Only overpressure stall enable effectively 2: Only deceleration process effectively 3: The whole is invalid	1	<input checked="" type="radio"/>
F1-25	Over-excitation Gain	0~200	100	<input type="radio"/>
F1-26	Over-excitation Filter Coefficients	0~10	3	<input type="radio"/>

Over-excitation control can inhibit the bus voltage rise, avoid the overvoltage fault. The bigger the over-excitation gain is, the better the inhibition effect is; buy over-excitation gain is too large, easy to cause the output current increases, need to weigh in the application. Increase the over-excitation filter coefficients to slow the speed of inverter response over-excitation control, on the contrary, you can speed up the inverter response the speed of over-excitation control.

F1-27	Acceleration/Deceleration Mode	0: Straight-line acceleration/deceleration 1: S curve acceleration/deceleration A 2: S curve acceleration/deceleration B	0	<input checked="" type="radio"/>
-------	--------------------------------	--	---	----------------------------------

Select the inverter frequency change mode in the process of start and stop.

0: Straight-line acceleration/deceleration

Output frequency increase or decrease according to the linear. VD120 provide four kinds of deceleration time. Select by multi-function digital input terminal (F5-01~F5-05).

1: S curve acceleration/deceleration A

Output frequency increase or decrease according to the S curve. S curve is used in the pace with gentle start or stop demand, such as elevator, conveyor belt, etc. Function code F1-28 and F1-29 respectively defined the time scale of inertial stage and finish stage of S curve acceleration/deceleration.

2: S curve acceleration/deceleration B

In the S curve acceleration/deceleration B, rated motor frequency f_b always S curve inflection point. As shown in figure 6-4. Generally used in the occasion that high-speed areas of above the rated frequency need to be rapid acceleration/deceleration.

When set frequency above rated frequency, deceleration time is:

$$t = \left(\frac{4}{9} \times \left(\frac{f}{f_b} \right)^2 + \frac{5}{9} \right) \times T$$

Among them, f is set frequency, f_b is the rated motor frequency, T is the time for 0 frequency accelerate to f_b rated frequency.

F1-28	Time Ratio of S Curve Start Segment	0.0%~(100.0%-F1-29)	30.0%	⊙
F1-29	Time Ratio of S Curve End Segment	0.0%~(100.0%-F1-28)	30.0%	⊙

Function code F1-28 and F1-29 respectively defined the time scale of inertial stage and finish stage of S curve acceleration/deceleration, two function code need to meet: $F1-28 + F1-29 \leq 100.0\%$

T1 in figure 6-4 is the F1-28 defined parameters, the slope of output frequency changes in this period of time increased gradually. T2 is the F1-29 defined time, the slope of output frequency changes in this period of time change to 0 gradually.

Between t1 and t2 time, the slope of output frequency changes is fixed, namely for linear acceleration/deceleration in this stage.

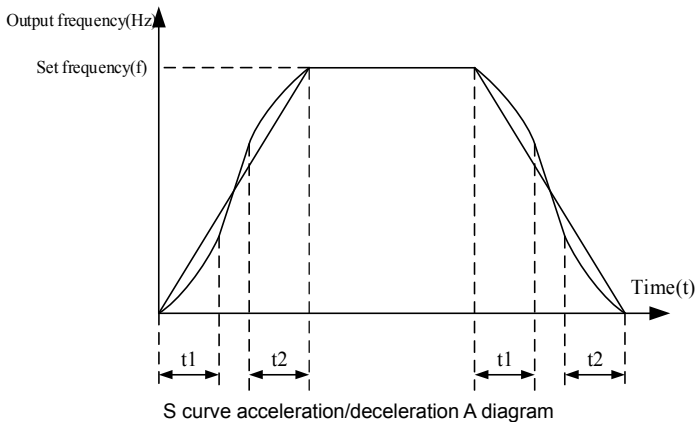

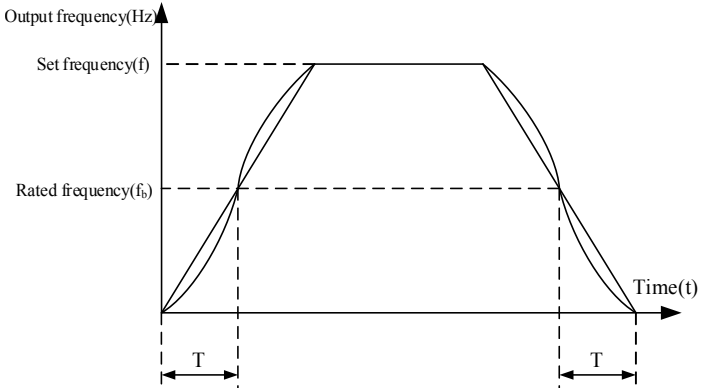

S curve acceleration/deceleration B diagram
 Fig 6-4 S curve acceleration/deceleration diagram

F2 Motor 1 Parameter

F2-00	Motor Type Selection	0: Ordinary asynchronous motor 1: Frequency conversion asynchronous motor	0	⊙
F2-01	Rated Motor Power	0.1kW~11.0kW	Model dependent	⊙
F2-02	Rated Motor Voltage	1V~1000V	Model dependent	⊙
F2-03	Rated Motor Current	0.01A~100.00A	Model dependent	⊙
F2-04	Rated Motor Frequency	0.01Hz~max frequency	Model dependent	⊙
F2-05	Rated Motor Rotation Speed	1RPM~65535RPM	Model dependent	⊙

The above function code for parameters of motor nameplates, whether using V/D control or vector control, all need according to the motor nameplate set the related parameters accurately.

In order to obtain better performance of V/F or vector control, motor parameter tuning is required, and the accuracy of the adjust results, close relation to correctly set motor nameplate parameters.

F2-06	Asynchronous Motor Stator Resistance	0.001Ω~65.535Ω	Tune parameter	⊙
F2-07	Asynchronous Motor Rotor Resistance	0.001Ω~65.535Ω	Tune parameter	⊙
F2-08	Asynchronous Motor Leakage Inductive Reactance	0.01mH ~655.35mH	Tune parameter	⊙

F2-09	Asynchronous Motor Mutual Inductive Reactance	0.1mH~6553.5mH	Tune parameter	⊙
F2-10	Asynchronous Motor No-load Current	0.01A~F2-03	Tune parameter	⊙

F2-06~F2-10 is the parameter of asynchronous motor, in generally the motor nameplate don't have these parameters, need through the inverter automatic tuning. Among them, the "asynchronous motor static tuning" can only get the F2-06~F2-08 three parameters, and "asynchronous motor complete tuning" besides can get here all five parameters, can also get the encode phase sequence, current loop PI parameter etc.

Change the rated motor power (F2-01) or rated motor voltage (F2-02), the inverter will automatically modify F2-06~F2-10 parameter values, return the five parameters for commonly used standard Y series motor parameters.

If the site can't tuned for asynchronous motor, can according to the parameters given by motor manufacturer, input the above corresponding function code.

F2-26	Tune Selection	0: No operation 1: Asynchronous motor static tuning 2: Asynchronous motor complete tuning	0	⊙
-------	----------------	---	---	---

0: no operation, namely the tuning is prohibited.

1: asynchronous motor static tuning, suitable for the occasion of asynchronous motor and load is not easy to release, but can't be complete tuning.

Asynchronous motor static tuning before, must be properly set motor type and motor nameplate parameters F2-00~F2-05. Asynchronous motor static tuning, inverter can obtain F2-06~F2-08 three parameters.

Action description: set the function code to 1, and then press RUN key, inverter will conduct static tuning.

2: asynchronous motor complete tuning

In order to guarantee the dynamic control performance of the frequency inverter, please select complete tuning, the motor must disconnect with load, and to keep the motor for the idling condition.

In the process of complete tuning, inverter conduct to static tuning first, and then according to the acceleration time F0-18 to the 80% of rated motor frequency, after a period of time, accordance with the deceleration time F0-19 slowing down and end tuning.

Before asynchronous motor is complete tuning, you need to setup the motor type and motor nameplate parameters F2-00~F2-05.

Asynchronous motor complete tuning, frequency inverter can get F2-06~F2-10 five motor parameters, vector control current loop PI parameter F3-13~F3-16.

Action description: set the function code to 2, and then press the RUN button, inverter will be complete tuning.

F3 Motor 1 Vector Control Parameter

F3-00	Speed Loop Proportional Gain 1	01~100	30	○
F3-01	Speed Loop Integral Time 1	0.01s~10.00s	0.50s	○
F3-02	Switch Frequency 1	0.00Hz~F3-05	5.00Hz	○
F3-03	Speed Loop Proportional Gain 2	1~100	20	○
F3-04	Speed Loop Integral Time 2	0.01s~10.00s	1.00s	○
F3-05	Switching Frequency 2	F3-02~max frequency	10.00Hz	○

Under different frequency inverter running, you can select a different speed loop PI parameters. When running frequency is less than the switching frequency 1 (F3-02), speed loop PI adjust the parameter to F3-00 and F3-01. When running frequency is greater than the switching frequency 2, speed loop PI adjust the parameter to F3-03 and F3-04. The speed loop PI parameter between switching frequency 1 and switching frequency 2, for linear switching of two group PI parameters, as shown in figure 6-5.

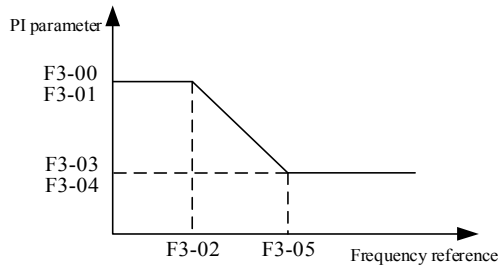

Fig 6-5 Parameter diagram

By setting the proportional coefficient and integral time of speed regulator, can adjust the speed of dynamic response characteristics of vector control.

Increase the proportional gain, reduce the integration time, the dynamic response of the speed loop. But the proportional gain is too large or integration is too less could make the system produce oscillation. Suggestion adjustment method is:

If factor parameters can't meet the requirements, then fine-tuning based on the factory value parameters, to increase the proportional gain, ensure system no oscillation; and then reduce the integration time, make the system with faster response characteristics, and smaller overshoot.

Note: if the PI parameters set is improper, may lead to excessive speed overshoot, even occur overvoltage fault in overshoot fall back.

F3-06	Vector Control Slip Gain	20%~200%	100%	○
-------	--------------------------	----------	------	---

To speed sensorless vector control, this parameter is used to adjust motor steady speed precision: low speed when the motor load is increasing this parameter, vice versa.

To speed sensor vector control, this parameter can adjust inverter output current size in the same loads.

F3-07	Speed Loop Filter Time Constant	0.000s~0.100s	0.000s	<input type="radio"/>
-------	---------------------------------	---------------	--------	-----------------------

Under the vector control mode, the output of the speed loop controller for torque current instruction, the parameter is used for filtering for torque instruction. Generally do not need to adjust the parameters, it can be appropriately increase the filtering time when speed is volatile; if motor volatility, this parameters should be reduced.

Speed loop filter time constant is small, the inverter output torque may be volatile, but the response of the speed is fast.

F3-09	Motor Torque Upper Limit Source	0: Encode F3-10 setting 1: AI1 2: AI2 3: AI3 4: PULSE setting 5: Communication setting 6: MIN (AI1, AI2) 7: MAX (AI1, AI2) The full scale of options 1~7 corresponding to the F3-10	0	<input type="radio"/>
F3-10	Digital Setting for Motor Torque Upper Limit	0%~200.0%	150.0%	<input type="radio"/>
F3-11	Brake Torque Upper Limit Source	0: Encode F3-12 setting 1: AI1 2: AI2 3: AI3 4: PULSE setting 5: Communication setting 6: MIN (AI1, AI2) 7: MAX (AI1, AI2) The full scale of options 1~7 corresponding to the F3-12	0	<input type="radio"/>
F3-12	Digital Setting for Brake Torque Upper Limit	0%~200.0%	150.0%	<input type="radio"/>

In speed control mode, the maximum value of the inverter output torque, by the torque limit source control.

F3-09, F3-11 is used to select the set source of torque upper limit, when setting by analog, PULSE, communication, 100% of corresponding set corresponding F3-10, F3-12 and 100% of F3-10, F3-12 is the inverter rated torque.

F3-13	Excitation Adjustment Proportional Gain	0~60000	2000	<input type="radio"/>
F3-14	Excitation Adjustment Integral Gain	0 ~60000	1300	<input type="radio"/>
F3-15	Torque Adjustment Proportional Gain	0~60000	2000	<input type="radio"/>

F3-16	Torque Adjustment Integral Gain	0~60000	1300	<input type="radio"/>
-------	---------------------------------	---------	------	-----------------------

Vector control current loop PI regulation parameter, the parameter will automatically receive after in the asynchronous motor complete tuning, generally do not need to be modified.

What need reminds is, current loop integral controller, integration time is not used as the dimension, but directly setting the integral gain. Current loop PI gain setting is too big, may lead to the control loops oscillation, so when the current oscillation or torque fluctuation change greatly, can be manually reduce the PI proportional gain and integral gain here.

F3-17	Speed Loop Integral Separation Enable	0: Disabled 1: Enabled	0	<input type="radio"/>
-------	---------------------------------------	---------------------------	---	-----------------------

To prevent the overregulation, generally do not need to adjust.

F3-20	Max Weak Magnetic Current	1%~300%	50%	<input type="radio"/>
F3-21	Weak Magnetic Automatic Gain Adjustment	10%~500%	100%	<input type="radio"/>
F3-22	Weak Magnetic Integral Multiples	2~10	2	<input type="radio"/>

Change the F3-21 and F3-22 can change the adjustment speed of weak magnetic current, but weak magnetic current adjust faster could lead to instability, generally do not need to manually modify.

F3-23	Torque Boost Coefficient	0.0%~60.0%	10.0%	<input type="radio"/>
F3-24	Torque Boost Cutoff Frequency	0.00Hz~max frequency	20.00	<input type="radio"/>

In order to compensate the speed vector control low frequency torque characteristics, inverter output voltage do some compensation when low frequency. But torque boost set is too large, motor easy to overheat, inverter is easy to overcurrent.

When the load is heavier and motor starting torque is not enough, suggest increase this parameter, can reduce the torque when the load is lighter.

F3-25	Exciting Current Compensation Gain	0~500	0	<input type="radio"/>
F3-26	Torque Current Compensation Gain	0~500	0	<input type="radio"/>
F3-27	Torque Response Gain	1~1000	10	<input type="radio"/>

For the excitation current and torque current compensation of electricity blows quantitative component in the vector control, generally do not need to be adjusted.

F4 Motor 1 V/F Control Parameter

This function code is only effective for V/F control, is invalid for vector control.

V/F control is suitable for general load such as fan, water pump, or one inverter with more motor, or inverter power and motor power different applications.

F4-00	V/F Curve Setting	0: Straight line V/F 1: Multipoint V/F 2: Square V/F 3: 1.2#power V/F 4: 1.4#power V/F 5: 1.6#power V/F 6: 1.8#power V/F 7: V/F complete separation mode 8: V/F half separation mode	0	⊙
-------	-------------------	--	---	---

0: straight line V/F. Suitable for ordinary constant torque load.

1: multipoint V/F. Suitable for dewatering machine, centrifuge and other special load. At this point by setting the F4-03~F4-08 parameters, arbitrary V/F relationship curves can be obtained.

2: Square V/F. Suitable for centrifugal load such as fans pumps.

3~6: V/F relationship curve between the straight line V/F and square V/F relationship curve.

7: V/F complete separation mode. The output frequency of frequency inverter and the output voltage are independent of each other, output frequency be determined by the frequency source, and output voltage be determined by F4-14 (V/F separation voltage source).

V/F complete separation mode, commonly used in these occasions such as induction heating, inverter power supply, torque motor control.

8: V/F half separation mode.

In this case V and F is proportional, but the proportion relationship can be set through the voltage source F4-14, and the relationship between V and F also with F1 group rated motor voltage and rated frequency.

Assuming input voltage source for X (X is the value of 0~100%), the relationship between inverter output voltage V and frequency F is:

$V/F=2*X*$ (rated motor voltage) / (rated motor frequency)

F4-01	Torque Boost Mode Selection	0: Automatic torque boost 1: Manual torque boost	0	⊙
F4-02	Manual Torque Boost	0.0%~30.0%	Model dependent	○
F4-03	Manual Torque Boost Cutoff Frequency	0.00Hz~max frequency	50.00Hz	⊙

In order to compensate for V/F control low frequency torque characteristics, do some compensation when the low frequency inverter output voltage. But torque boost is too large, motor easy to overheat, inverter is easy to overcurrent.

When the heavier load and motor starting torque is not enough, suggest increase this parameter. Can reduce the torque boost when lighter load.

When the torque boost is set to 0.0, frequency inverter is automatic torque boost, the frequency inverter according to the motor stator resistance parameters etc. automatic calculation the torque of appreciation.

Torque increase torque cut-off frequency: under this frequency, torque boost torque effectively, more than the set frequency, torque boost failure, see below instructions.

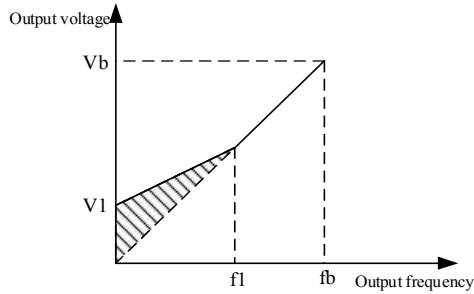

V1: manual torque boost voltage Vb: max output voltage
 f1: manual torque boost cutoff frequency fb: rated running frequency

Fig 6-6 Manual torque boost diagram

F4-04	MS V/F Frequency Point 1	0.00Hz~F4-06	0.00Hz	⊙
F4-05	MS V/F Voltage Point 1	0.0%~100.0%	0.0%	⊙
F4-06	MS VF Frequency Point 2	F4-04~F4-08	0.00Hz	⊙
F4-07	MS V/F Voltage Point 2	0.0%~100.0%	0.0%	⊙
F4-08	MS V/F Frequency Point 3	F4-06~Rated motor frequency (F2-04)	0.00Hz	⊙
F4-09	MS V/F Voltage Point 3	0.0%~100.0%	0.0%	⊙

F4-04~F4-09 six parameters defined multistage V/F curve.

The curve of multipoint V/F should set according to the motor load characteristic, what need note is, the relationship between the three point voltage and frequency points must be satisfied: $V1 < V2 < V3$, $F1 < F2 < F3$. Figure 6-7 is multipoint V/F curve set diagram.

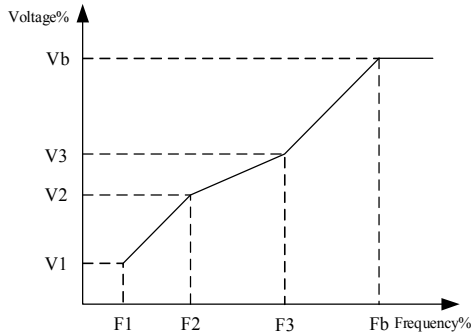

V1-V3: MS speed V/F voltage percentage of 1-3 section
 F1-F3: MS speed V/F frequency percentage of 1-3 section
 Vb: rated motor voltage Fb: rated motor running frequency

Fig 6-7 Multipoint V/F curve set diagram

Voltage set too high may lead to motor overheating or even burning when low frequency, frequency inverter may be loss of speed or overcurrent protection.

F4-10	V/F Slip Compensation Gain	0.0%~200.0%	20.0%	☉
-------	----------------------------	-------------	-------	---

This parameter is only effective for asynchronous motor.

V/F slip compensation gain: can compensate asynchronous motor caused motor speed deviation when the load increases, to make the speed of the motor can basically remained stable when the load changes.

V/F slip compensation gain is set to 100.0%, says the slip of compensation for the rated motor slip when the motor with rated load, and rated motor slip is by the inverter through F2 group rated motor frequency and rated speed to calculate gain.

Adjust the V/F slip compensation gain, general when under rated load, motor speed and the target speed basically the same as the principle. When the motor speed and the target value is not at the same time, need appropriate fine-tuning the gain.

F4-12	V/F Oscillation Suppression Gain	0~100	Model dependent	○
-------	----------------------------------	-------	-----------------	---

The selection method of the gain is as far as possible on the premise of effectively restrain oscillation in small, in order to avoid an adverse effect on operation of V/F.

Please select the gain is 0 when motor no oscillation phenomenon. Only in the obvious oscillation of the motor, should be appropriate to increase the gain and the greater the gain, the more obvious the suppression of the oscillation.

When using suppression oscillation function, wants the rated motor current and no-load current parameters accurately, otherwise the V/F oscillation suppression effect is not good.

F4-14	The Separation of V/F Voltage Source	0: Digital setting (F4-15) 1: AI1 2: Reserved 3: Reserved 4: PULSE setting 5: MS instruction 6: Simple PLC 7: PID 8: Communication given Remark: 100% corresponding rated motor voltage	0	○
F4-15	V/F Separation Voltage Digital Setting	0V~rated motor voltage	0V	○

V/F separation is commonly used in these occasions such as induction heating, inverter power supply and torque motor control.

When choosing V/F separation control, output voltage can be through the function code F4-15 set, also can come from the analog quantity, MS instruction, PLC, PID or communication given. When using the non-numeric set, 100% corresponding rated motor voltage, when the percentage of the analog output setting such as negative, is to set by absolute value as a valid value.

0: Digital setting (F4-14)

The voltage set directly by the F4-15.

1: AI1

Voltage by the analog inputs to determined.

4: PULSE setting (DI5)

Voltage is given by the terminal pulse.

Pulse given signal specifications: voltage range: 9V~30V, frequency range: 0kHz~100kHz.

5: MS instruction

When voltage source for MS instruction, to set up the F5 and FC group parameters, to determine the corresponding relation of given signal and given voltage.

6: Simple PLC

When voltage source for simple PLC, you need to set up the FC group parameters to determine given output voltage.

7: PID

According to the PID closed-loop produce output voltage. Specific content see introduce of FA group.

8: Communication given

Refers to the voltage by the HC is given by way of communication.

When above voltage source to select 1~8, 0%~100% are corresponding to the output voltage 0V~rated motor voltage.

F4-16	V/F Separation Voltage Rise Time	0.0s~1000.0s Remark: Indication the time that 0V rise to rated motor voltage	5.0s	○
F4-17	V/F Separation Voltage Fall Time	0.0s~1000.0s Remark: Indication the time that rated motor voltage drop to 0V	5.0s	○

VF separation voltage rise time refers to the time needed for output voltage to be changed from the 0V to the rated motor voltage, the V/F separation voltage fall time refers to the time required for output voltage to be changed from rated motor voltage to 0V. As show below diagram.

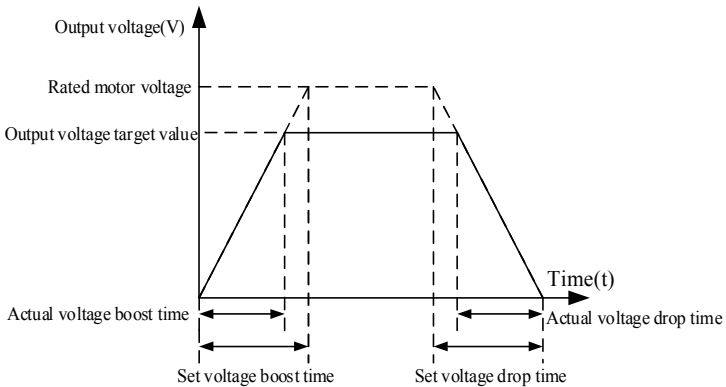

Fig 6-8 V/F separation diagram

F5 Input Terminal Group

VD120 series inverter with six multi-function digital input terminals (including HDI1 can be used as a high speed pulse input terminal), two analog input terminals.

F5-00	Terminal Command Mode	0: Two-line mode 1 1: Two-line mode 2 2: Three-line mode 1 3: Three-line mode 2 4: Alternate control 5: Back and forth control	0	⊙
-------	-----------------------	---	---	---

This parameter defines five different modes of controlling the operation of the inverter via the external terminals

1: Two-line mode 1: This mode is the most commonly used two-line mode. The forward / reverse rotation of the motor is decided by the commands of Dix, Dly terminals; when Dix and Dly are effective, the inverter to keep the first effective terminal determined direction. The terminal function set as below:

Terminal	Set Value	Description
Dix	1	Forward run
Dly	2	Reverse run

Dix ,Dly is DI1~DI5 ,HDI1 Multi-function digital input terminals, electric level enabled.

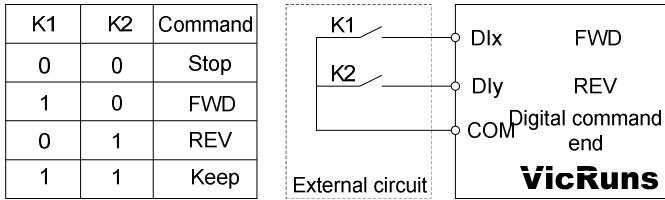

Fig 6-9 Schematic diagram of two line mode 1

Two-line mode 2: When this mode is adopted, Dix is enabled terminal. The direction is determined by the status of Dly. Terminal function set as below.

Terminal	Set Value	Description
Dix	1	Running
Dly	2	(FWD/REV)

Dix ,Dly is DI1~DI5 ,HDI1 Multi-function digital input terminals, electric level Enabled.

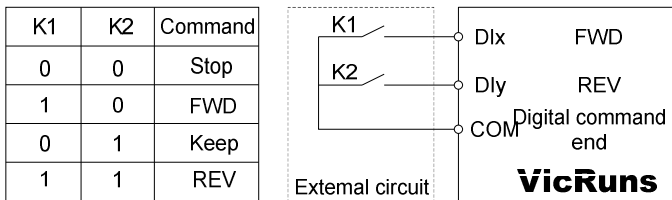

Fig 6-10 Schematic diagram of two line mode 2

Three-line control mode 1: In this mode, Din is enabled terminal, and the direction is controlled by

Dlx ,Dly respectively. Terminal function set as below.

Terminal	Set Value	Description
Dlx	1	Running
Dly	2	(FWD/REV)
Dln	3	Three-line control mode 1

- (1) When need to run, must be closed Dln terminals first, implemented by Dlx or Dly pulse rising to realize the motor forward or reverse control;
- (2) When need to stop, it should be done by disconnect Dln terminal signal;
- (3) The Dlx, Dly, Dln is DI1 ~ DI5, HDI1 multi-function digital quantity input terminals, Dlx, Dly for pulse effectively, the Dln of level effectively;

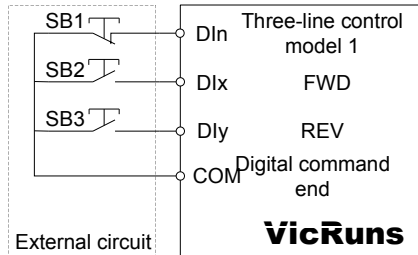

Fig 6-11 Three-line control mode 1

SB1: Stop button SB2: Forward rotation button SB3: Forward rotation button

Three-line control mode 2: In this mode, Dln is enabled terminal, and the run command is given by Dlx, while the direction is determined by the status of Dly. Terminal function as below:

Terminal	Set Value	Description
Dlx	1	Running
Dly	2	(FWD/REV)
Dln	3	Three-line control mode 2

- (1) When need to run, must be closed Dln terminals first, produced by Dlx pulse rising along the motor run signals, Dly status produce motor rotating direction signals.
- (2) When need to stop, it should be done by disconnect Dln terminal signal.
- (3)The Dlx, Dly, Dln is DI1 ~ DI5, HDI1 multi-function input terminals, Dlx for pulse effectively, Dly, Dln for level effectively.

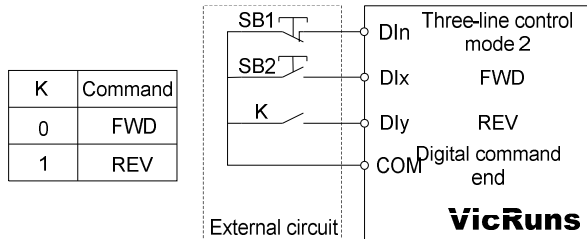

Fig 6-12 Three-line control mode 2

SB1: Stop button SB2: Run button K: forward/reverse switchover

Alternative control mode: this mode Din as enabled terminal, run and the rotating direction and stop are separately controlled by Din Dly alternatively. Terminal function as below:

Terminal	Set Value	Description
Dix	1	Forward, stop
Dly	2	Reverse, stop
DIn	3	Alternative control mode

Din terminal must be closed before operating, the initial pulse rising by DI x Dly to control motor forward or reverse rotating, the second pulse rising to control stop, and such repeat operation to control inverter start/ stop. Note: Dix or Dly as start signal and meanwhile as direction signal, if as stop signal then the effect is the same. As for the first time after the electricity through Dix terminal to make it produce a pulse let inverter is run, the need to stop when the second pulse can be produced by Dix delay can also be produced by the Dly, the third pulse will delay let inverter is up and run, run direction by a third impulse signal is produced Dix or pulse produced by Dly.

At the same time, through disconnect DIn terminal signal can also achieve the downtime control frequency converter.

Among them, the Dix, Dly, DIn is DI1 ~ DI5, HDI1 multi-function digital quantity input terminals, Dix, Dly for pulse effectively, the DIn of level effectively.

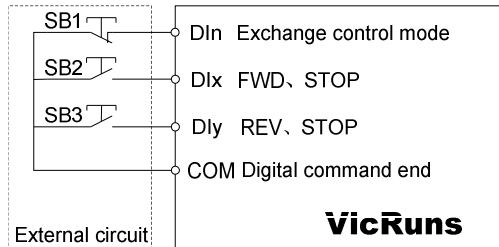

Fig 6-13 Alternate control mode

SB1: Stop button ,SB2: FWD ,STOP button ,SB3: REV ,Stop button

Back and forth control mode: Din is encode terminal, Dix, Dly is reverse control terminal. Terminal function as below:

Terminal	Set Value	Description
Dix	1	Forward, stop
Dly	2	Reverse, stop
DIn	3	Back and forth control mode

Din terminal must be closed before operating, then motor will run according to the previous memories direction (initial running default forward), when receiving the Dix or Dly pulse rising single, the motor will reverse running relative to before running direction, interval time more than the time set by F5-63, receive the Dix or Dly pulse rising single again, the motor will reverse again, and that cycle repeats.

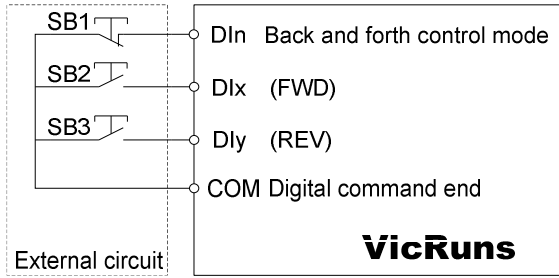

Fig 6-14 Back and forth control mode

F5-01	D11 Terminal Function Selection	0~53, see table blow	1	⊙
F5-02	D12 Terminal Function Selection		2	⊙
F5-03	D13 Terminal Function Selection		4	⊙
F5-04	D14 Terminal Function Selection		6	⊙
F5-05	DI5 Terminal Function / HD11 Pulse Input Function Selection (Optional)		8	⊙

This parameter is used to set the functions of the multifunctional digital input terminals.

Set Value	Function	Description
0	No function	The terminals not being used can be set "no function", to avoid wrong operation.
1	Forward running	Via external terminals to control inverter forward reverse run
2	Reverse running	
3	Three-line run control	Via this terminal to confirm the inverter run mode is 3line run or alternative control mode. Refer to the function code F5-00 ("terminal command mode") description.
4	Forward Jog(FJOG)	FJOG is jog forward run, RJOG is jog reverse run. Jog run frequency, jog Acceleration/down time refer to function code Fb-00, Fb-01, Fb-02 description.
5	Reverse Jog(RJOG)	
6	Coast to stop	Inverter block output, at present motor stop is not controlled by inverter. This method is the same as F1-08 described coast to stop.
7	Run pause	Inverter deceleration stop, but all run parameter is in memory state. Such as PLC parameters, swing frequency parameters, PID parameters. After this terminal signal disappears, inverter back to running state before the parking.

8	Fault reset (RESET)	Using terminal function to reset error, the same function as keypad RESET. This function can realize long distance error reset.
9	External fault input	When external error signal pulse sent to inverter, inverter alarm error Err.17, and according to the fault protection action approach to trouble shooting (details refer to the function code F9-36).
10	External fault normally closed input	After the external fault normally closed signal into frequency inverter, inverter report fault Err.17 and downtime.
11	Frequency setting increase (UP)	By external terminal pre-set frequency to change frequency up/down command. Setting frequency can be goes up/down when frequency source setting for the digital setting.
12	Frequency setting decrease (DOWN)	
13	UP/DOWN setting clear (terminal, keyboard)	When frequency preset is digital preset, the terminal can clear terminal UP/DOWN or keypad UP/DOWN to change frequency, to make given frequency back to F0-09 set value.
14	Switching frequency source	Used for switch to select a different frequency source. Select function code (F0-05) settings according to frequency source, when set to switch between two frequency sources as frequency source, the terminal is used to implement switch in the two kinds of frequency source.
15	Frequency source A switching with preset frequency	The terminal is effective, the frequency source A replaced by preset frequency (F0-09).
16	Frequency source B switching with preset frequency	The terminal is effective, the frequency source B replaced by preset frequency (F0-09).
17	MS speed terminal 1	It can realize 16S speed through the combination of digital status of these four terminals. Refer attached table 1 for the 16 MS speed function and other 16 commands.
18	MS speed terminal 2	
19	MS speed terminal 3	
20	MS speed terminal 4	

21	Acceleration and deceleration time selection terminal 1	It can realize 4 kinds of acceleration/deceleration time selection through the 4 states of two terminals.
22	Acceleration and deceleration time selection terminal 2	
23	PULSE frequency input (Only effective for HDI1)	HDI1 as the function of the pulse input terminals.
24	Control command switch terminal 1	Used to switch between the keypad control and terminal control. If command source selection for the keypad control, then switch system for terminal control when terminal is effective; vice versa.
25	Control command switch terminal 2	Used to switch between the terminal control and communication control. If command source selection for the terminal control, then switch system for communication control when terminal is effective; vice versa.
26	Immediate DC braking	This terminal is valid, and the inverter directly switchover to the DC braking state.
27	Deceleration DC braking	The terminal is valid, slow down to stop inverter and DC braking starting frequency, and then switchover to DC braking state.
28	External stop terminal 1 (Only effective for keypad control)	Can use the terminal to make inverter downtime when the keypad control, equivalent to the STOP key function on the keypad.
29	External stop terminal 2 (According to the deceleration time 4)	In any control mode (panel control, terminal control, communication control), can use the terminal to make the frequency inverter deceleration and stop, then the deceleration time fixed for deceleration time 4 at this time.
30	Emergency stop	The terminal is enabled, inverter stop at Fb-09 set time.
31	PID pause	PID temporary failure, the inverter to maintain the current output frequency, the PID adjustment of frequency source no longer.
32	PID integral pause	When terminal is valid, then the integral regulating function of PID suspended, but the proportion adjustment and the differential adjustment function of PID is still valid.
33	Reverse PID action direction	The terminal is valid, PID action direction and the direction of FA-03 set is opposite.
34	PID parameter switching	When PID parameter switching condition is DI terminal (FA-18=1), and the terminal is invalid, PID parameter using the FA-05~FA-07; when terminal is valid, then use the FA-15~FA-17.
35	PLC pause	PID temporary failure, the inverter to maintain the current output frequency, the PID adjustment of frequency source no longer.

36	PLC state reset	PLC is suspended in the process of execute, can make inverter back to initial state of simple PLC through the terminal when run again.
37	Swing frequency pause	The inverter output at center frequency, swing frequency function pause.
38	Swing frequency reset	The inverter output at center frequency, swing frequency function valid.
39	Switching between speed control and torque control	Make inverter switching between torque control and speed control. When the terminal is invalid, the inverter running on the defined mode of A0-00 (speed/torque control mode); when the terminal is valid, then switch to another mode.
40	Torque control prohibit	Prohibited inverter for torque control, inverter into speed control mode.
41	Acceleration and deceleration prohibit	Ensure the inverter is not affected by external signal (except halt command), to maintain the current output frequency.
42	Reverse prohibit	Motor reverse is not allowed.
43	Frequency modification prohibit	If the function is set to effectively, when frequency is changed, the inverter is not response the frequency change, until the terminal state is invalid.
44	Counter input	Count input terminal of pulse.
45	Counter reset	To reset the counter status.
46	Length count input	The input terminal of length count.
47	Length reset	Reset length.
48	Motor selection terminal	Through four kinds of condition of two terminals, can realize four groups of motor parameters switch, the detailed content see table 3.
50	User-defined failure 1	When the user-defined fault 1 and 2 is valid, the inverter respectively alarm Err. 35 and Err. 36, the inverter will be based on the fault protection action to select the action mode selected by the F9-38.
51	User-defined failure 2	
52	Cleared the running time	When the terminal is valid, the running time of the inverter is cleared, and the function needs to be used in conjunction with the time (Fb-38) and the running time (Fb-33).
53	Switching between two-line and three-line mode (Switch is invalid in running)	If the current is two line control mode, the terminal is valid, switch to the three control mode; if the current is three line control mode, the terminal is valid, switch to two line control mode.

Attached Table 1 MS Speed Function Description

4 MS speed command terminals can be combined into 16 kinds of status, which corresponding to 16 command set value, as shown in table 1.

K4	K3	K2	K1	Direct setting	Corresponding Parameter
OFF	OFF	OFF	OFF	MS speed 0	FC-00
OFF	OFF	OFF	ON	MS speed 1	FC-01
OFF	OFF	ON	OFF	MS speed 2	FC-02
OFF	OFF	ON	ON	MS speed 3	FC-03
OFF	ON	OFF	OFF	MS speed 4	FC-04
OFF	ON	OFF	ON	MS speed 5	FC-05
OFF	ON	ON	OFF	MS speed 6	FC-06
OFF	ON	ON	ON	MS speed 7	FC-07
ON	OFF	OFF	OFF	MS speed 8	FC-08
ON	OFF	OFF	ON	MS speed 9	FC-09
ON	OFF	ON	OFF	MS speed 10	FC-01
ON	OFF	ON	ON	MS speed 11	FC-11
ON	ON	OFF	OFF	MS speed 12	FC-12
ON	ON	OFF	ON	MS speed 13	FC-13
ON	ON	ON	OFF	MS speed 14	FC-14
ON	ON	ON	ON	MS speed 15	FC-15

When frequency source is choosing as multi-stage speed, the 100.0% of function code FC-00~FC-15 corresponding with max output frequency F0-10.

Multistage speed instruction except as a multistage speed function, also can be a given source of PID, in order to meet the different demand of various setup value.

Attached Table 2 acceleration/deceleration time selecting terminal function description

Terminals 1	Terminals 2	Acceleration/Deceleration time selection	Corresponding Parameter
OFF	OFF	Acceleration/deceleration 0	F0-19-F0-15
OFF	ON	Acceleration/deceleration 1	F0-03-F0-04
ON	OFF	Acceleration/deceleration 2	F0-05-F0-06
ON	ON	Acceleration/deceleration 3	F0-07-F0-08

F5-10	D11 Terminal Mode Selection 1 Effectively	Unit's digit: DI1 0: High level effective 1: Low level effective Ten's digit: DI2, same as above Hundred's digit: DI3, same as above Thousand's digit: DI4, same as above Ten thousand's digit: DI5, same as above	0x00000	©
-------	---	--	---------	---

Used to set the valid state model of digital quantity input terminal.

When selection for high level is valid, the corresponding DI terminal is valid connected with the COM, and is invalid disconnection.

When selection for low level is valid, the corresponding DI terminal is invalid connected with the COM, and is valid disconnection.

F5-12	DI Filter Time	0.000s~1.000s	0.010s	<input type="radio"/>
-------	----------------	---------------	--------	-----------------------

Set the software filter time of DI terminal state. If the input terminal of the usa occasion is easy to be interfered an caused by the wrong action, the parameter can be increased to enhance the anti-interference ability. But the filter time increases can cause DI terminal response slow.

F5-13	DI1 Close Delay Time	0.0s~3600.0s	0.0s	<input checked="" type="radio"/>
F5-14	DI2 Close Delay Time	0.0s~3600.0s	0.0s	<input checked="" type="radio"/>
F5-15	DI3 Close Delay Time	0.0s~3600.0s	0.0s	<input checked="" type="radio"/>
F5-16	DI1 Open Delay Time	0.0s~3600.0s	0.0s	<input checked="" type="radio"/>
F5-17	DI2 Open Delay Time	0.0s~3600.0s	0.0s	<input checked="" type="radio"/>
F5-18	DI3 Open Delay Time	0.0s~3600.0s	0.0s	<input checked="" type="radio"/>

Is used to set DI terminal state changes, delay time of the frequency inverter for the change.

Only DI1, DI2, DI3 have the function that set the delay time at present.

F5-19	Terminal UP/DOWN change rate	0.001Hz/s~65.535Hz/s	1.000 Hz/s	<input type="radio"/>
-------	------------------------------	----------------------	------------	-----------------------

Used to set the terminal UP/DOWN to adjust the setting frequency, the speed of frequency change, that is the frequency variation per second. When F0-15 (frequency decimal point) is 2, the value range is from 0.001Hz/s to 65.535Hz/s.

F5-20	AI Curve Selection	AI1 curve selection 1: Curve 1 (2 point, see F5-22~F5-26) 2: Curve 2 (2 point, see F5-27~F5-31) 3: Curve 3 (2 point, see F5-32~F5-36) 4: Curve 4 (4 point, see b2~00-b2-07) 5: Curve 5 (4 point, see b2-08~b2-15)	1	<input type="radio"/>
-------	--------------------	---	---	-----------------------

The function code are used to select the analog input AI1 corresponding set curve, each analog input can choose any one of 5 kinds of curves. Curve 1, 2, 3 are 2 point curve, set in the F5 group function code, and the curve 4 and 5 are 4 points, need to set in the function code in group b2.

F5-21	AI is Lower than Min Input Setting Selection	AI1 is lower than min input setting selection 0: Corresponding to the min input setting 1: 0.0%	0	<input type="radio"/>
-------	--	---	---	-----------------------

The function code is used for setting, when the voltage of the analog input is smaller than the “minimum input” set, how to determine the setting of analog corresponds.

If selection is 0, when the AI input is lower than the “minimum input”, then the analog corresponding setting for “minimum input corresponding setting” of function code to determine the curve (F5-27, F5-22).

If selection is 1, when the AI input is lower than the minimum input, then the analog corresponding setting is set to 0.0%.

F5-22	AI Curve 1 Min Input	-10V~F5-24	0.00V	<input type="radio"/>
F5-23	Corresponding Setting of AI Curve 1 Min Input	-100.0%~+100.0%	0.0%	<input type="radio"/>
F5-24	AI Curve 1 Max Input	F5-22~+10.00V	10.00V	<input type="radio"/>
F5-25	Corresponding Setting of AI Curve 1 Max Input	-100.0%~+100.0%	100.0 %	<input type="radio"/>
F5-26	AI 1 Filter Time	0.00s~10.00s	0.10s	<input type="radio"/>

The above function code is used to set the relationship between the analog input voltage and the setting value of the representative.

When the analog input voltage is greater than the set “maximum input” (F5-24), the analog voltage is calculated according to the “Maximum input”; similarly, when the analog input voltage is less than the set “maximum input” (F5-22), depending on the “AI is lower than the minmum input set selection” (F5-21) settings, with the minimum input or 0.0% calculation.

When analog input for the current input, 1mA current equivalent to a 0.5V voltage (AI1 jumper wire to the current file).

AI1 input filter time, used to set AI1 software filter time, when the on-site analog is easily effected, then increase filter time to make detecting analog signal getting steady. But the filter time is bigger, the analog signal detecting response speed is lower. Please consider the actual situation to set.

In different application, analog set 100.0% is different from its corresponding nominal value, please refer to application description. Fig 6-15 is two typical setting situation:

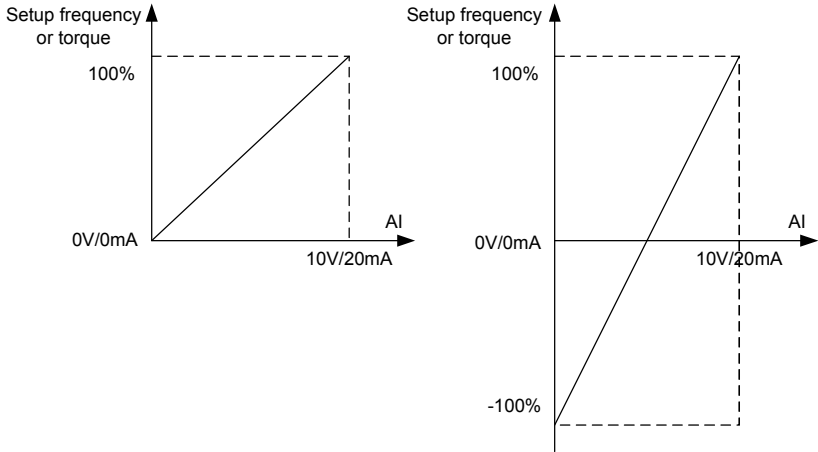

Fig.6-15 Corresponding Relationship between Analog Reference and Setting

F5-27	AI Curve 2 Min Input	-10.00V~F5-29	0.00V	○
F5-28	Corresponding Setting of AI Curve 2 Min Input	-100.0%~+100.0%	0.0%	○
F5-29	AI Curve 2 Max Input	F5-27~+10.00V	10.00V	○
F5-30	Corresponding Setting of AI Curve 2 Max Input	-100.0%~+100.0%	100.0%	○
F5-31	AI 2 Filter Time	0.00s~10.00s	0.10s	○

The function and using method of curve 2, please refer to the instructions of curve 1.

F5-32	AI Curve 3 Min Input	-10.00V~F5-34	0.00V	○
F5-33	Corresponding Setting of AI Curve 3 Min Input	-100.0%~+100.0%	0.0%	○
F5-34	AI Curve 3 Max Input	F5-32~+10.00V	10.00V	○
F5-35	Corresponding Setting of AI Curve 3 Max Input	-100.0%~+100.0%	100.0%	○
F5-36	AI3 Filter Time	0.00s~10.00s	0.10s	○

The function and using method of curve 3, please refer to the instructions of curve 1.

F5-37	Pulse Min Input	0.00kHz~F5-39	0.00kHz	○
F5-38	Corresponding Setting of Pulse Min Input	-100.0%~+100.0%	0.0%	○
F5-39	Pulse Max Input	F5-37~100.00kHz	50.00kHz	○
F5-40	Corresponding Setting	-100.0%~+100.0%	100.0%	○

	of Pulse Max Input			
F5-41	PULSE Filter Time	0.00s~10.00s	0.10s	○

The group function code is used to set the relationship between HDI1 pulse frequency set and corresponding setting.

Pulse frequency can only be input into the inverter through the HDI1 channel.

The application of the group is similar to the curve 1, please refer to the instructions of curve 1.

F5-42	Travel Switch Lock Time	0.00s~10.00s	1.00s	○
-------	-------------------------	--------------	-------	---

It used to terminal control operation mode 5 (back and forth control), please refer to the specific instructions of back and forth control mode.

F6 Output Terminal Function Group

F6-00	DO1 Terminals Output Mode Selection	0: HDO1 pulse output (optional) 1: Switch output	1	○
-------	-------------------------------------	---	---	---

DO1 terminal is programmable multiplexing terminal. It can be used as high-speed pulse output terminal, it can also be used as collector open circuit output terminal, high speed pulse output function is optional, if you need this feature, you need to contact the manufacturer in advance.

When as a pulse output, the highest frequency of the output pulse is 100kHz, related functions refer to the instruction of F6-12.

F6-01	DO1 Output Terminals Function Selection	0~42, see table blow	0	○
F6-02	Relay T1 Function Selection		0	○

Digit output terminal function table:

Set Value	Function	Description
0	No output	Output terminals without any function.
1	Inverter in running	It indicate the inverter is in running state, have the output frequency(can be zero), output ON signal at this time.
2	Ready for run	When the inverter main circuit and control loop is stable, and the inverter is not detected any fault information, and the inverter is in the running sate, output ON signal.
3	Fault output 1 (no output when continue to run)	When the inverter is failure (except when the fault protection action is continue operation), output ON signal.
4	Fault output 2 (no output undervoltage or continue to run)	When the inverter is failure (except when undervoltage or fault protection action is continue operation), output ON signal.
5	Warning output 3 (output when fault)	When the inverter is failure, output ON signal.
6	Output undervoltage	When the inverter is in undervoltage condition, output ON signal.
7	Frequency level detection FDT1 output	Please refer to the instruction of function code Fb-16, Fb-17.
8	Frequency level detection FDT2 output	Please refer to the instruction of function code Fb-18, Fb-19.
9	Frequency reached	Please refer to the instruction of function code Fb-20.
10	Frequency 1 reached output	Please refer to the instruction of function code Fb-21, Fb-22.
11	Frequency 2 reached output	Please refer to the instruction of function code Fb-23, Fb-24.
12	Zero speed running 1 (no output when stop)	When frequency inverter is running and the output frequency is 0, then output ON signal. When inverter is in a state of downtime, the signal is OFF.

13	Zero speed running 2 (output when stop)	When frequency inverter is running and the output frequency is 0, then output ON signal. When inverter is in a state of downtime, the signal also is ON.
14	Frequency upper limit reached	When operation frequency reach to the upper limit frequency, output ON signal.
15	Frequency lower limit reached 1 (no output when stop)	When operation frequency reach to the lower limit frequency, output ON signal. When inverter is in a state of downtime, the signal is OFF.
16	Frequency lower limit reached 2 (output when stop)	When operation frequency reach to the lower limit frequency, output ON signal. When inverter is in a state of downtime, the signal also is ON.
17	Current 1 reached output	Please refer to the instruction of function code Fb-29, Fb-30.
18	Current 2 reached output	Please refer to the instruction of function code Fb-31, Fb-32.
19	Zero current state	Please refer to the instruction of function code Fb-25, Fb-26.
20	Output current limit exceeded	Please refer to the instruction of function code Fb-27, Fb-28.
21	Motor overload pre-alarm	Before overload protection, according to the overload forecasting warning threshold value to judge, after more than forecasting warning threshold output ON signal. Parameter set refer to the function code F8-00~F8-02.
22	Inverter overload pre-alarm	In the first 10s in inverter overload protection, output ON signal.
23	During the load	When frequency inverter during the load, output ON signal.
24	Set Count value reached	When the count value reach to the set value of Fb-59, output ON signal.
25	Designated count value reached	When the count value reach to the set value of Fb-60, output ON signal. Count function refer to the function instruction of Fb group.
26	Length reached	When the actual length of testing more than Fb-56 setting length, output ON signal.
27	Module temperature reached	Radiator temperature of inverter module (FF-11) meet the module settings of the temperature reaches the value (Fb-39), output ON signal.
29	Current running time reached	When frequency inverter current running time more than the setting time of Fb-33, output ON signal.
30	Accumulative running time reached	When frequency inverter accumulative running time more than the setting time of Fb-35, output ON signal.
31	Accumulative power-on time reached	When frequency inverter accumulative power-on time more than the setting time of Fb-35, output ON signal.
32	Timing reached output	When timing function selection (Fb-36) is valid, after inverter running time reach to set timing time, output ON signal.

33	PLC circulation output	When simple PLC operation to finished a cycle, output a pulse signal whit 250ms width.
34	Frequency limit	When set frequency exceed frequency upper limit or frequency lower limit, and the inverter output frequency reaches frequency upper limit or frequency lower limit, output ON signal.
35	Torque limit	Inverter in speed control mode, when output torque reaches the torque limit value, the inverter in the stall protection state, output ON signal at the same time time.
36	Reverse running	When frequency inverter in reverse running, output ON signal.
37	AI1 input limit	When the value of analog input AI1 is more than Fb-41 (AI1 input protection upper limit) or less than Fb-40 (AI1 input protection lower limit), output ON signal.
39	Communication setting	Please refer to the communication protocol.
41	Timing braking (power on braking)	Please refer to the instruction of function code Fb-48, Fb-49.
42	Inverter in running (jog no output)	Said the inverter is in running state, have the output frequency (can be zero), except jog, then output ON signal.

F6-06	DO Output Terminal Effective State Selection	Unit's digit: HDO1 0: Positive logic 1: Anti-logic Ten's digit: RELAY1, same as above	0x00	○
-------	--	--	------	---

Define the output logic of HDO1 and relay 1.

0: Positive logic, digital output terminal and the corresponding pipic end connected to valid state, disconnect as invalid state;

1: Anti-logic, digital output terminal and the corresponding public end connected as the invalid state, disconnect for valid state.

F6-07	HDO1 Closing Delay	0.0s~3600.0s	0.0s	○
F6-08	T1 Closing Delay	0.0s~3600.0s	0.0s	○

Set the closing delay time of output terminal HDO1 and relay 1, from the state to change to the actual output changes.

F6-12	HDO1 Output Function Selection	0~15, see table below	0	○
F6-13	AO1 Output Function Selection		0	○

Analog output AO1 and AO2 output range is 0V~10V or 0/4mA~20mA. HDO1 terminal output pulse frequency range is 0.01kHz~F6-15(output max frequency when HDO1 pulse output mode), F6-15 can be set from 0.01kHz~100.00kHz. Pulse or analog signal output 0.0%~100.0% corresponding function as below table:

Set value	Function	Description
0	Running frequency	0~maximum output frequency
1	Set frequency	0~maximum output frequency
2	Output current	0~2 times of rated motor current
3	Output torque	0~2 times of rated motor voltage
4	Output power	0~2 times of rated power
5	Output voltage	0~1.2 times of inverter rated power
6	PULSE input	0.01kHz~100.00kHz (100% corresponding 100.0kHz)
7	AI1	0V~10V
8	Reserved	Reserved
9	Reserved	Reserved
10	Length	0~maximum set length
11	Count value	0~Max count value
12	Communication setting	0.0%~100.0%
13	Motor rotate speed	0~maximum output frequency corresponding rotate speed
14	Output current	100% corresponding 1000.0A
15	Output voltage	0.0V~1000.0V (100% corresponding 100.0kHz)

F6-15	HDO1 Output Max Frequency	0.01kHz~100.00kHz	50.00kHz	○
-------	---------------------------	-------------------	----------	---

When selecting HDO1 terminals as pulse output, the function code is used to select the maximum frequency value of the output pulse.

F6-16	AO1 Output Voltage Lower Limit	0.00V~10.00V	0.00V	○
F6-17	Corresponding Setting Value of AO1 Output Voltage Lower Limit	0.0%~F6-19	0.0%	○
F6-18	AO1 Output Voltage Upper Limit	0.00V~10.00V	10.00V	○
F6-19	Corresponding Setting Value of AO1 Output Voltage Upper Limit	F6-17~100.0%	100.0%	○
F6-20	AO1 Output Filter Time	0.00s~10.00s	0.00s	○

The function code used to set the relation of analog output voltage and its representing set value.

When AO1 output is the current output, 1mA current is equal to 0.5V voltage, so 20mA current equal to 10V (AO1 jumper wire to the current file).

F6-26	AO1 Output Type	0: Voltage 1: Current	0	<input type="radio"/>
-------	-----------------	--------------------------	---	-----------------------

AO1 has two modes of voltage and current output, at the same time, the corresponding output type of hardware is selected, and the corresponding parameters are selected for the same type.

F6-27	HDO1 Disconnect Delay	0.0s~3600.0s	0.0s	<input type="radio"/>
F6-28	T1 Disconnect Delay	0.0s~3600.0s	0.0s	<input type="radio"/>

Set the closing delay time of output terminal HDO1 and relay 1, from the state to change to the actual output changes.

F7 Keyboard and Display Function Group

F7-00	JOG / REV Key Function Selection	0: Invalid 1: Operation panel command channel switching with remote command channel (terminal command channel or communication command channel) 2: FWD/REV switching 3: Forward jog 4: Reverse jog 5: Rapid debugging	3	◎
-------	----------------------------------	--	---	---

JOG/REV keys for the multi-function key, can be set by the function code JOG/REV key functions. This key can be used to switch in stop and running.

0: This key invalid

1: Operation panel command channel switching with remote command channel

Refer to the command source switching, namely panel command source switching with communication command source. If current command source is keypad control, then the key function is valid.

2: FWD/REV switching

The direction of frequency command is switched by JOG/REV key. The function is valid only in the command source for the operation panel command channel.

3: Forward jog

Through the keypad JOG/REV key to realize forward jog.

4: Reverse jog

Through the keypad JOG/REV key to realize reverse jog.

5: Rapid debugging

Through the keypad JOG/REV key to switch to the rapid debug interface, the specific interface content reference FF-05 parameter description.

F7-01	STOP / RESET Key Function	0: STOP/RES key stop function is valid only in keypad operation mode 1: STOP/RES key stop function all valid in any operation mode	1	○
-------	---------------------------	---	---	---

This parameter is used to set the function selection of STOP/RESET key.

Remark: the "RESET" is always valid for the reset function, regardless of the value of the parameter settings.

F7-02	LED Running Display Parameter 1	0000~0xFFFF Bit00: Running frequency 1 (Hz) Bit01: Setting frequency (Hz) Bit02: Bus voltage (V) Bit03: Output voltage (V) Bit04: Output current (A) Bit05: Output power (kW) Bit06: Output torque (%) Bit07: DI input state Bit08: DO output state Bit09: AI1 voltage (V)	0x001F	○
-------	---------------------------------	--	--------	---

		Bit10: Reserved Bit11: Reserved Bit12: Count value Bit13: Length value Bit14: Load speed display BIT15: PID setting		
F7-03	LED Running Display Parameter 2	0000~0xFFFF Bit00: PID feedback Bit01: PLC stage Bit02: PULSE input frequency (kHz) Bit03: Running frequency 2 (Hz) Bit04: Set torque (0.%) Bit05: Voltage before Al1 correction (V) Bit06: Reserved Bit07: Reserved Bit08: Line speed Bit09: Current power on time (Hour) Bit10: Current running time (Min) Bit11: PULSE input frequency (Hz) Bit12: Communication setting value Bit13: Reserved Bit14: Main frequency A display (Hz) Bit15: Auxiliary frequency B display (Hz)	0x0000	○

Inverter in run condition, parameter display is subjected to the function code, which is a 16 bit binary number, if one bit is 1, the corresponding parameters of the bit at run time, can see through the shift key. If the bit is 0, then the corresponding parameters will not be displayed. The lower the bit is, the higher the display priority is.

Comparison table of operating display low bit F7-02		Comparison table of operating display low bit F7-03	
Corresponding display parameter	Hexadecimal	Corresponding display parameter	Hexadecimal
Running frequency(Hz)	0x0001	PID feedback	0x0001
Set frequency(Hz)	0x0002	PLC stage	0x0002
Bus voltage(V)	0x0004	PULSE input pulse frequency	0x0004
Output voltage(V)	0x0008	Running frequency	0x0008
Output current(A)	0x0010	Set torque (%)	0x0010

Output power (kW)	0x0020	AI1 voltage before correction (V)	0x0020
Output torque (%)	0x0040	Reserved	0x0040
DI input state	0x0080	Reserved	0x0080
DO output state	0x0100	Linear velocity	0x0100
AI1 voltage (V)	0x0200	Current power on time (Hour)	0x0200
Reserved	0x0400	Current running time (Min)	0x0400
Reserved	0x0800	PULSE input frequency (Hz)	0x0800
Count value	0x1000	Communication set value	0x1000
Length value	0x2000	Reserved	0x2000
Load speed display	0x4000	Main frequency A display (Hz)	0x4000
PID setting	0x8000	Auxiliary frequency B display (Hz)	0x8000

If you want to show multiple parameters (switch by shift key display), only to input hexadecimal addition results of that several parameter.

F7-04	LED Display Stop Parameter	0000~0x3FFF Bit00: Set frequency (Hz) Bit01: Bus voltage (V) Bit02: DI input state Bit03: DO output state Bit04: AI1 voltage (V) Bit05: Reserved Bit06: Reserved Bit07: Count value Bit08: Length value Bit09: PLC stage Bit10: Load speed Bit11: PID setting Bit12: Pulse input frequency (kHz) Bit13: Set torque (0.1%)	0x0033	○
-------	----------------------------	---	--------	---

Inverter in stop state, the parameters according to the function code, which is a 16 bit binary number, if one is 1, then the corresponding parameters can be during downtime, can see through the shift key. If the bit is 0, then the corresponding parameters will not be displayed. The lower bits, the higher the display priority is. Please refer to the operation display parameters detailed setting method.

Stop display parameter F7-04 corresponding table	
Corresponding display parameter	Hexadecimal

Set frequency (Hz)	0x0001
Bus voltage (V)	0x0002
DI input state	0x0004
DO output state	0x0008
AI1 voltage (V)	0x0010
Reserved	0x0020
Reserved	0x0040
Count value	0x0080
Length value	0x0100
PLC stage	0x0200
Load speed	0x0400
PID setting	0x0800
PULSE input frequency (kHz)	0x1000
Setting torque (0.1%)	0x2000

If you want to show multiple parameters (switch by shift key display), only to input hexadecimal addition results of that several parameter.

F7-05	The Second Line LED Running Display Parameters	0~15 corresponding bit0~bit15 of F7-02 16~31 corresponding bit0~bit15 of F7-03	4	<input type="radio"/>
F7-06	The Second Line LED Stop Display Parameters	0~13 corresponding bit0~bit13 of F7-05	1	<input type="radio"/>

When use the double line show keyboard, can select a display value by these two parameters, but the function is the decimal input.

F7-07	Load Speed Display Coefficient	0.0001~6.5000	1.0000	<input type="radio"/>
F7-08	Load Speed Display Decimal Places	0: 0 bit decimal place 1: 1 bit decimal place 2: 2 bit decimal place 3: 3 bit decimal place	1	<input type="radio"/>

When need to display the load speed, should adjust the corresponding relation of inverter output frequency and load speed.

Below illustrates the calculation of load speed:

If load speed display coefficient F7-07 is 2.000, the load speed decimal digits F7-08 to 2 (two decimal point), when inverter running frequency for 40.00Hz, load speed is: $40.00 \times 2.000 = 80.00$ (two decimal point display).

If the inverter in a stop state, the load speed display for set frequency corresponding to the speed, namely "setting load speed". At a set frequency of 50.00Hz for example, the stop state load speed is: $50.00 \times 2.000 = 100.00$ (two decimal point display).

F8 Protection Parameters

F8-00	Motor Overload Protection Selection	0: Disabled 1: Enabled	1	<input type="radio"/>
F8-01	Motor Overload Protection Gain	0.20~10.00	1.00	<input type="radio"/>

F8-00=1: no motor overload protection function, there may be a motor overheating damage risk, suggest adding thermal relay between inverter and motor.

F8-00=1: inverter according to the motor overload protection inverse time curve determine whether the motor overload at this moment.

Inverse time curves of the motor overload protection are as follows: 220% X (F8-01) X rated motor current, last 1 minute alarm motor overload fault; 150% X (F8-01) X rated motor current, last 60 minutes alarm motor overload.

User needs according to the actual overload capacity of motor, set up the F8-01 value correctly, if set the parameter is too big easy to cause the damage of motor overheating, and inverter is not alarm.

F8-02	Motor Overload Warning Coefficient	50%~100%	80%	<input type="radio"/>
-------	------------------------------------	----------	-----	-----------------------

This function is used to in the front of the motor overload fault protection, through the DO give a warning signal to control system. The warning coefficient used to determine how much to warning before the motor overload protection. The greater the value, the smaller the warning advance.

When the inverter output current cumulants is greater than the product of overload inverse time curve with F8-02, inverter multi-function digital DO output the "motor overload warning" ON signal.

F8-06	Overvoltage/over current Stall Mode Selection	0: Mode 0 1: Mode 1	≤11kW: 1	⊙
			>11kW: 0	
F8-07	Overvoltage Stall Proportion Gain	0: Disabled 1~100	10	<input type="radio"/>
F8-08	Overvoltage Stall Integral Gain	0~100	5	<input type="radio"/>
F8-09	Overvoltage Stall Protection voltage	100.0VDC~800.0VDC	380VAC: 700.0VDC	<input type="radio"/>
			220VAC: 370.0VDC	

In the process of frequency converter to slow down, when DC bus voltage more than the overvoltage stall protection voltage, frequency converter to stop deceleration to keep on the current running frequency, after waiting for bus voltage drops to continue to deceleration.

Overvoltage stall gain, used to adjust in the process of deceleration, inverter overvoltage control capability. The bigger the value is, the greater the inhibition of overvoltage ability is. On the premise of not occur overvoltage, the gain settings as small as possible.

For small inertia load, the gain of the overvoltage stall is small is better, otherwise the system dynamic response is slow. For large inertia load, this value should be larger, otherwise the suppression effect is not good, may appear overvoltage fault.

When overvoltage stall gain is set to 0, cancel the function of overvoltage stall.

F8-10	Over current Stall Proportion Gain	0: Disabled 1~1000	20	<input type="radio"/>
F8-11	Over current Stall Integral Gain	0~1000	20	<input type="radio"/>

F8-12	Over current Stall Protection Current	100%~200%	160%	<input type="radio"/>
F8-13	Quick Start Over current Suppression Gain	0~100	30	<input type="radio"/>

In process of inverter acceleration/deceleration, when output current more than overcurrent stall protection current, frequency converter to stop deceleration process, keep the current running frequency, after the output current drops to continue to acceleration/deceleration.

Overcurrent stall gain, used to adjust in the process of acceleration/deceleration, frequency converter overcurrent control capability. The bigger the value is, the greater the inhibition of overcurrent ability is. On the premise of not occur overcurrent, the gain settings as small as possible.

For small inertia load, the gain of the overcurrent stall is small is better, otherwise the system dynamic response is slow. For large inertia load, this value should be larger, otherwise the suppression effect is not good, may appear overcurrent fault.

When overcurrent stall gain is set to 0, cancel the function of overcurrent stall..

F8-14	Short-circuit to Ground Upon Power-on	0: Invalid 1: Valid	1	<input type="radio"/>
-------	---------------------------------------	------------------------	---	-----------------------

Can select the inverter in the power, to detect whether the motor is short circuit to ground.

If this function is effective, then inverter UVW terminal will have voltage output after power on a period of time.

F8-15	Input Phase Loss Protection Selection	0: Disabled 1: Enabled	1	<input type="radio"/>
-------	---------------------------------------	---------------------------	---	-----------------------

Select whether to protect the input phase loss.

Just G type 11 kW and above power of VD120 inverter have the input phase loss protection function, P type machine under the power of 7.5 kW, regardless of F8-13 set to 0 or 1 no input phase protection function.

F8-16	Output Phase Loss Protection Selection	0: Disabled 1: Enabled	1	<input type="radio"/>
-------	--	---------------------------	---	-----------------------

Select whether to protect the output phase loss.

F8-17	Offload Protection Selection	0: Invalid 1: Valid	0	<input type="radio"/>
F8-18	Offload Detection Level	0.0~100.0%	10.0%	<input type="radio"/>
F8-19	Offload Detection Time	0.0s~60.0s	1.0s	<input type="radio"/>

If offload protection function is effective, then when the inverter output current is less than the offload detection levels F8-18 and duration time is greater than the offload detection time F8-19, the inverter output frequency decreased to 7% of the rated frequency automatically. During the offload protection, if the load recovery, then frequency inverter automatic recovery to run according to set frequency.

F8-24	Action Selection Upon Instantaneous Power Failure	0: Invalid 1: Decelerate 2: Decelerate to stop	0	<input type="radio"/>
F8-25	Voltage Restore Judgment Value Upon Instantaneous Power Failure	F8-27~100.0%	90.0%	<input type="radio"/>

F8-26	Voltage Restore Judgment Time Upon Instantaneous Power Failure	0.00s~100.00s	0.50s	○
F8-27	Voltage Judgment Value Upon Instantaneous Power Failure	60.0%~100.0% (Standard bus voltage)	80.0%	○

The function is refers to the instantaneous power failure or voltage falls suddenly, frequency converter by reducing output rotational speed, reduce the load feedback energy compensation inverter DC bus voltage is reduced, to keep the inverter to continue to run.

If F8-24 =1, when instantaneous power failure or voltage falls suddenly, frequency converter deceleration, when the bus voltage returns to normal, inverter normal acceleration to set frequency operation. Is used as the basis of bus voltage return to normal is bus voltage more than F8-25 set voltage recovery judging value and duration time more than F8-26 set time. If F8-24=2, when instantaneous power failure or voltage falls suddenly, inverter deceleration until the stop.

F8-28	Maximum Change of V/F Over Voltage Stall	0: No limit 1~30000	800	○
-------	--	------------------------	-----	---

By a control over the maximum change of the overvoltage stall, the overvoltage stall can be suppressed more effectively.

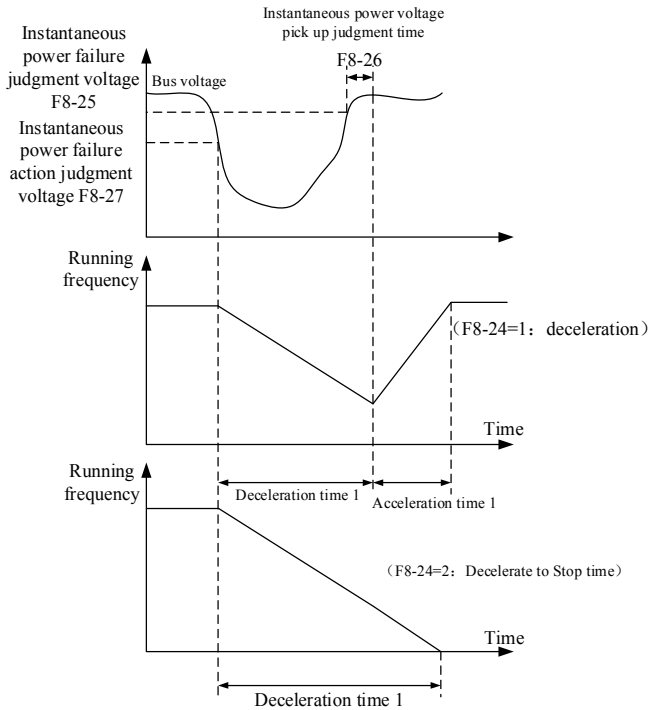

Fig 6-16 Schematic diagram of instantaneous power failure

F9 Fault Record and Setting Parameter Group

F9-00	Fault Types for the First Time	0~43	-	●
F9-01	Fault Types for the Second Time		-	●
F9-02	Fault Types for the Third Time (Last Time)		-	●

Record recently three failure types of inverter, 0 is no fault. For the possible causes and solutions of each fault code, please refer to the instructions in chapter 8.

F9-03	Frequency Upon the Third Time (Last Time) Fault	-	-	●
F9-04	Current Upon the Third Time (Last Time) Fault	-	-	●
F9-05	Bus Voltage Upon the Third Time (Last Time) Fault	-	-	●
F9-06	Input Terminal State Upon the Third Time (Last Time) Fault	-	-	●
F9-07	Output Terminal State Upon the Third Time (Last Time) Fault	-	-	●
F9-08	Inverter State Upon the Third Time (Last Time) Fault	-	-	●
F9-09	Power on Time Upon the Third Time (Last Time) Fault	-	-	●
F9-10	Running Time Upon the Second Time Fault	-	-	●
F9-13	Frequency Upon the Second Time Fault	-	-	●
F9-14	Current Upon the Second Time Fault	-	-	●
F9-15	Bus Voltage Upon the Second Time Fault	-	-	●
F9-16	Input Terminal State Upon the Second Time Fault	-	-	●
F9-17	Output Terminal State Upon the Second Time Fault	-	-	●
F9-18	Inverter State Upon the Second Time Fault	-	-	●

F9-19	Power on Time Upon the Second Time Fault	-	-	●
F9-20	Running Time Upon the Second Time Fault	-	-	●
F9-23	Frequency Upon the First Time Fault	-	-	●
F9-24	Current Upon the First Time Fault	-	-	●
F9-25	Bus Voltage Upon the First Time Fault		-	●
F9-26	Input Terminal State Upon the First Time Fault		-	●
F9-27	Output Terminal State Upon the First Time Fault	-	-	●
F9-28	Inverter State Upon the First Time Fault	-	-	●
F9-29	Power on Time Upon the First Time Fault	-	-	●
F9-30	Running Time Upon the First Time Fault	-	-	●
F9-33	Fault Automatic Reset Times	0~20	0	○
F9-34	Fault Automatic Reset Interval Time	0.1s~100.0s	1.0s	○
F9-35	Fault DO Action Selection During the Fault Automatic Reset	0: No action 1: Action	0	○
F9-36	Fault Protection Action Selection 1	Unit's digit: motor overload (11) 0: Coast to stop 1: Stop according to stop mode 2: Continue to run Ten's digit: input phase loss (13) 0: Coast to stop 1: Stop according to stop mode 2: Continue to run Hundred's digit: output phase loss (14) 0: Coast to stop 1: Stop according to stop mode 2: Continue to run Thousand's digit: external fault (17) 0: Coast to stop 1: Stop according to stop mode 2: Continue to run	0x0000 0	○

		<p>Ten thousand's digit: communication abnormal (18)</p> <p>0: Coast to stop</p> <p>1: Stop according to stop mode</p> <p>2: Continue to run</p>		
F9-37	Fault Protection Action Selection 2	<p>Unit's digit: reserved</p> <p>Ten's digit: parameter read-write abnormal (21)</p> <p>0: Coast to stop</p> <p>1: Stop according to stop mode</p> <p>2: Continue to run</p> <p>Hundred's digit: running time reached (27)</p> <p>0: Coast to stop</p> <p>1: Stop according to stop mode</p> <p>2: Continue to run</p> <p>Thousand's digit: reserved</p> <p>Ten thousand's digit: reserved</p>	0x0000 0	○
F9-38	Fault Protection Action Selection 3	<p>Unit's digit: user-defined fault 1 (35)</p> <p>0: Coast to stop</p> <p>1: Stop according to stop mode</p> <p>2: Continue to run</p> <p>Ten's digit: user-defined fault 2 (36)</p> <p>0: Coast to stop</p> <p>1: Stop according to stop mode</p> <p>2: Continue to run</p> <p>Hundred's digit: power on time reached (28)</p> <p>0: Coast to stop</p> <p>1: Stop according to stop mode</p> <p>2: Continue to run</p> <p>Thousand's digit: offload (37)</p> <p>0: Coast to stop</p> <p>1: Stop according to stop mode</p> <p>2: Decelerate to 7% of the rated motor frequency continue running, automatically restored to the set frequency operation when no offload</p> <p>Ten thousand's digit: PID feedback lost when running (23)</p> <p>0: Coast to stop</p> <p>1: Stop according to stop mode</p> <p>2: Continue to run</p>	0x0000 0	○

F9-39	Fault Protection Action Selection 4	Unit's digit: Disconnection detection fault (22) 0: Coast to stop 1: Stop according to stop mode 2: Continue to run Ten's digit: reserved Hundred's digit: reserved Thousand's digit: reserved Ten thousand's digit: reserved	0x00000	○
-------	-------------------------------------	--	---------	---

When the option is "coast to stop", inverter show Err. **, and directly downtime.

When the option is "according to the stop way to stop": inverter show A. **, and press down way down, show Err. ** after stop.

When the option is "continue to run" : frequency converter continue to run and displays A. **, running frequency is set by F9-40.

F9-40	Continue Running Frequency Selection at Failure	0: Run to the current running frequency 1: Run at set frequency 2: Run at frequency upper limit 3: Run at frequency lower limit 4: Run at abnormal standby frequency	0	○
F9-41	Abnormal Standby Frequency	0.0%~100.0% (100.0% corresponding max frequency F0-10)	100.0%	○

When the inverter malfunction during the operation, and the processing mode of fault is set to continue to run, frequency converter show Arr. **, and operation according to the frequency of F9-40 determine.

When operation selecting an anomaly standby frequency, the value set by F9-41 is the percentage relative to the maximum frequency.

FA Process PID Parameter Group

Process PID closed-loop control is the control mode in the control system using proportion (P), integral (I) and differential (D) controller of three parts, make the deviation between the feedback value and the instruction value gradually reduced, suitable for the flow rate, pressure, temperature and other process control.

Proportional control (P)

The control variable of proportional to the deviation.

Integral control (I)

The control variable of proportional to deviation integral value, can eliminate the steady-state error.

Differential control (D)

The control variable of proportional to deviation variation rate, can predict the change trend of deviation, rapid response to the dramatic changes, improve the dynamic performance, but easy to introduce and enlarge the interference signals and cause the system unstable, please use caution.

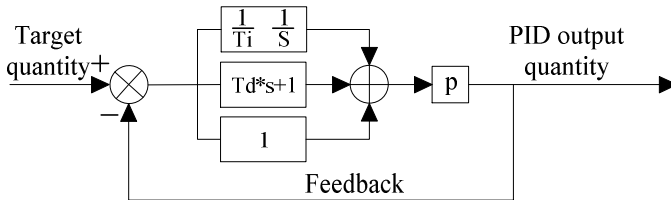

Fig 6-17 Process PID principle block diagram

FA-00	PID Given Source	0: FA-01 setting 1: AI1 2: Reserved 3: Reserved 4: PULSE setting 5: Communication setting 6: Multi-reference setting 7: Keypad potentiometer	0	○
FA-01	PID Digital Giving	0.0%~100.0%	50.0%	○

This parameter is used to select the target volume for a given channel of process PID.

The set target volume of the process PID for the relative value, set range is 0.0%~0.0%. Similarly, the feedback quantity of PID also is relative quantity, the function of PID is to make the two relatively equal.

FA-02	PID Feedback Source	0: A1 1: Reserved 2: Reserved 3: Reserved 4: PULSE setting 5: Communication setting	0	○
-------	---------------------	--	---	---

This parameter is used to select the feedback signal channel of process PID.

The feedback quantity of process PID is also relative value, setting range is 0.0% ~ 100.0%.

FA-03	PID Action Direction	0: Positive action 1: Anti-action	0	<input type="radio"/>
-------	----------------------	--------------------------------------	---	-----------------------

Positive action: when the feedback signal of PID is less than the quantitative, the output frequency of inverter is increased. Such as the tension control of the winding situation.

Anti-action: when the feedback signal of PID is less than the quantitative, the output frequency of inverter is decreased. Such as the tension control of the rolling situation.

This function is influenced by the multi-function terminal PID direction invert (function 33), need to pay attention in the using.

FA-04	PID Given Feedback Range	0~65535	1000	<input type="radio"/>
-------	--------------------------	---------	------	-----------------------

PID given feedback range is a dimensionless unit for PID given display U0-15 and PID feedback display U0-16.

The relative value 100.0% of a given feedback of PID corresponding to a given feedback range FA - 04. For example, if the FA - 04 set to 2000, when the PID given 100.0%, PID given show U0-15 is 2000.

FA-05	Proportion Gain Kp1	0.0~100.0	20.0	<input type="radio"/>
FA-06	Integral Time Ti1	0.01s~10.00s	2.00s	<input type="radio"/>
FA-07	Differential Time Td1	0.000s~10.000s	0.000s	<input type="radio"/>

The proportional gain Kp1

Determine the adjusting strength of the PID regulator, the greater the Kp1, the greater the intensity of regulation. This parameter 100.0 said when PID feedback quantity and give quantitative deviation are 100.0%, PID regulator to adjust the amplitude of output frequency instructions for maximum frequency.

Integration time Ti1

Determine the intensity of the PID regulator integral regulation. The shorter the integration time, the greater the intensity of adjustment. Integration time is when the PID feedback quantity and give quantitative deviation are 100.0%, integral regulator through the time continuous adjustment, adjust the quantity to reach the maximum frequency.

Differential time Td1

Determine the intensity of the PID regulator to adjust the deviation change rate. The longer the differential time, the greater the intensity of regulation. Differential time is when the feedback quantity in the time to change 100.0%, the regulation quantity of differential controller is maximum frequency.

FA-08	PID Reverse Cut-off Frequency	0.00Hz ~max frequency	0.00Hz	<input type="radio"/>
-------	-------------------------------	-----------------------	--------	-----------------------

In some cases, it is only when the PID output frequency is negative (i.e., frequency converter reverse), PID is likely to give quantitative and feedback control to the same state, but the high inversion frequency is not allowed in some situations, FA - 08 used to determine the lower limit of reverse frequency.

FA-09	PID Deviation Limit	0.0%~100.0%	0.0%	<input type="radio"/>
-------	---------------------	-------------	------	-----------------------

When the deviation between the PID quantitative and feedback quantity is less than the FA - 09, PID stop adjustment action. In this way, the deviation of a given and feedback output frequency is stable when small, is very effective for some closed-loop control occasions.

FA-10	PID Differential Limiting	0.00%~100.00%	0.10%	<input type="radio"/>
-------	---------------------------	---------------	-------	-----------------------

In PID controller, the effect of differential is more sensitive, easy to cause system oscillation, therefore, generally limit the effect of differential PID in a smaller range, FA - 10 is used to set the PID differential output range

FA-11	PID Given Change Time	0.00s~650.00s	0.00s	○
-------	-----------------------	---------------	-------	---

PID given changes time, refers to the PID given value time needed from 0.0% to 100.0%.

When PID given changes, PID given value according to the given time linear changes, reduce adverse effects caused by given mutations on the system.

FA-12	PID Feedback Filter Time	0.00s~60.00s	0.00s	○
-------	--------------------------	--------------	-------	---

FA-13	PID Output Filter Time	0.00s~60.00s	0.00s	○
-------	------------------------	--------------	-------	---

FA-12 used to filter the PID feedback, which can reduce the influence of feedback, but leads to the response performance of the process closed-loop system.

FA-13 used to filter the PID output frequency, the filter will weaken the mutation the of inverter output frequency, but also leads to the response performance of the process closed-loop system.

FA-15	Proportion Gain Kp2	0.0~100.0	20.0	○
FA-16	Integral Time Ti2	0.01s~10.00s	2.00s	○
FA-17	Differential Time Td2	0.000s~10.000s	0.000s	○
FA-18	PID Parameters Switching Condition	0: No switching 1: Switching through DI terminal 2: Automatic switching according to the deviation	0	○
FA-19	PID Parameters Switching Deviation 1	0.0%~FA-20	20.0%	○
FA-20	PID Parameters Switching Deviation 2	FA-19~100.0%	80.0%	○

In some applications, a set of PID parameters can not meet the needs of the whole operation process, need to adopt different PID parameters under different conditions.

This set of function is used to switch between two groups of PID parameters. The set mode of controller parameters FA-15-FA-17 is similar with parameter FA-05-FA-07.

Two groups of PID parameters can be switch by multi-functional digital DI terminal, can also according to the deviation of PID automatic switching.

Selection for the multi-function DI terminal switch, the multi-function terminal selection is set to 34 (PID parameter switch terminal), when the terminal is invalid selecting parameters group 1 (FA-05 - FA-07), when terminal is valid selecting parameters group 2 (FA-15-FA-17).

Selection for automatic switching, when the absolute value of the deviation between the given and feedback is less than PID parameter switch deviation 1 FA-19, PID parameters selection parameter group 1. When the absolute value of deviation between given and feedback is greater than PID parameter switch deviation 2 FA-20, PID parameters selection parameter group 2. When the deviation between the given and feedback is between switch deviation 1 and 2, the PID parameter is a linear interpolation of two set of PID parameter, as shown in the figure below.

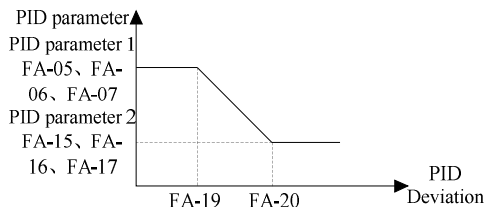

Fig 6-18 Schematic diagram for PID parameters automatically switchover

FA-21	PID Initial Value	0.0%~100.0%	0.0%	<input type="radio"/>
FA-22	PID Initial Value Hold Time	0.00s~650.00s	0.00s	<input type="radio"/>

When the frequency converter starts up, the PID output is fixed to the PID initial FA-21, continuous PID initial value after holding time FA-22, PID to start the closed-loop adjustment operation.

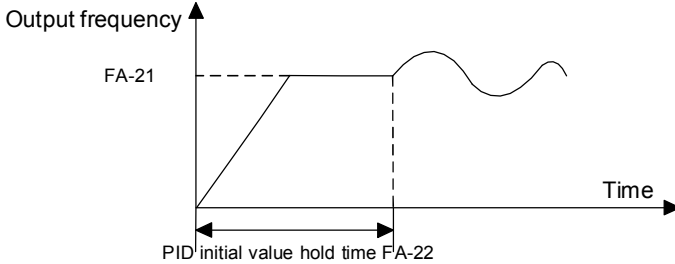

Fig 6-19 Schematic diagram of PID initial value

This function is used to limit the difference between the PID output two beats (2ms/beat), in order to suppress the PID output changes too fast, make the inverter running stable.

FA-23	Twice Output Deviation Positive Maximum Value	0.00%~100.00%	1.00%	<input type="radio"/>
FA-24	Twice Output Deviation Reverse Maximum Value	0.00%~100.00%	1.00%	<input type="radio"/>

FA-23 and FA-24 respectively corresponding the maximum value of the absolute value of the output deviation in forward and reverse.

FA-25	PID Integral Property	Unit's digit: integral separation 0: Disabled 1: Enabled Ten's digit: whether stop integral after output the limit 0: Continue integral 1: Stop integral	0x00	<input type="radio"/>
-------	-----------------------	---	------	-----------------------

Integral separation

If set up integral separation is effective, then when the multifunction digital DI integral pause (function 32) is valid and PID integral stop operation, the PID only proportional and differential function effectively.

When the integral separation selection for invalid, no matter whether the multi-function digital DI is valid, integral separation is invalid.

Whether to stop the integral after output to the limit

After the PID operation output reached the maximum or minimum value, can selection whether to stop the integral action. If selection for stop integral, then the PID integral stop calculation, which may help to reduce the overshoot amount of PID.

FA-26	PID Feedback Lost Detection Value	0.0%: Don't judge feedback lost 0.1%~100.0%	0.0%	<input type="radio"/>
FA-27	PID Feedback Lost Detection Time	0.0s~20.0s	0.0s	<input type="radio"/>

FA-28	PID Feedback Lost Detection Starting Frequency	0.00Hz~max frequency	10.00Hz	<input type="radio"/>
-------	--	----------------------	---------	-----------------------

This function code is used to determine whether PID feedback is lost.

When the PID feedback quantity is less than the feedback loss detection values FA-26, and duration more than PID feedback loss detection time FA-27, frequency converter alarm fault Err. 23, and deal with according to the selected fault processing method.

FA-29	PID Stop Operation	0: No operation when stop 1: Operation when stop	0	<input type="radio"/>
-------	--------------------	---	---	-----------------------

Used to select the PID in stop condition, PID whether to continue operations. General application in the case of PID should stop operation under the stop condition.

FA-30	The Lower Limit Value of Feedback when PID Action	0.0%: No limit 0.1%~100.0%	0.0.%	<input type="radio"/>
-------	---	-------------------------------	-------	-----------------------

When the PID feedback value is less than the lower limit, the PID regulation does not act, which is mainly used to reduce PID regulation and maintain the stability of the system.

Fb Enhance Function Group

Fb-00	Jog Running Frequency	0.00Hz~max frequency	5.00Hz	<input type="radio"/>
Fb-01	Jog Acceleration Time	0.0s~6500.0s	Model dependent	<input type="radio"/>
Fb-02	Jog Deceleration Time	0.0s~6500.0s	Model dependent	<input type="radio"/>

Definition the given frequency and acceleration/deceleration time of frequency converter in jog.

When jog running, the start mode is fixed to the direct start mode (F1-00=0) and the stop mode is fixed to the deceleration stop (F1-08=0).

Fb-03	Acceleration Time 2	0.0s~6500.0s	Model dependent	<input type="radio"/>
Fb-04	Deceleration Time 2	0.0s~6500.0s	Model dependent	<input type="radio"/>
Fb-05	Acceleration Time 3	0.0s~6500.0s	Model dependent	<input type="radio"/>
Fb-06	Deceleration Time 3	0.0s~6500.0s	Model dependent	<input type="radio"/>
Fb-07	Acceleration Time 4	0.0s~6500.0s	Model dependent	<input type="radio"/>
Fb-08	Deceleration Time 4	0.0s~6500.0s	Model dependent	<input type="radio"/>

VD120 provide four groups of acceleration/deceleration time, respectively F0-18/F0-19 and the above three groups of acceleration/deceleration time.

The definition of four groups of acceleration/deceleration time are exactly the same, please reference F0-18 and F0-19 related instructions.

Through the different combination of the multi-function digital inputs terminal DI, it can be switched to select 4 groups of acceleration/deceleration time, the specific use method, please refer to the relevant instructions in the functional code F5-01~F5-05.

Schedule 1 is the terminal functional specifications of acceleration/deceleration time selection.

Fb-09	Emergency Stop Time	0.0s~6500.0s	10.0s	<input type="radio"/>
-------	---------------------	--------------	-------	-----------------------

When the DI function 30 is effective, the set time of Fb-09 will be decelerate to stop.

Fb-10	Acceleration Time 1 and time 2 Switching Frequency Point	0.00Hz~max frequency	0.00Hz	<input type="radio"/>
Fb-11	Deceleration Time 1 and time 2 Switching Frequency Point	0.00Hz~max frequency	0.00Hz	<input type="radio"/>

The function in the motor selection for 1 and not through the DI terminal switch to select the acceleration/deceleration time effectively. Used in the process of inverter running, not through the DI terminal but according to the running frequency range, selection different acceleration/deceleration time.

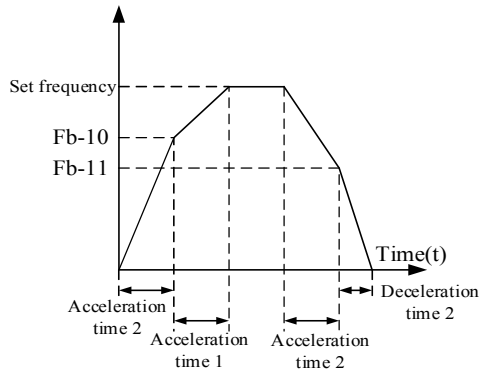

Fig 6-20 Schematic diagram of acceleration/deceleration time switching

Fb-12	Hopping Frequency 1	0.00Hz: frequency hopping point is invalid 0.01Hz~max frequency	0.00Hz	<input type="radio"/>
Fb-13	Hopping Frequency 2	0.00Hz: frequency hopping point is invalid 0.01Hz~max frequency	0.00Hz	<input type="radio"/>
Fb-14	Hopping Frequency Range	0.01Hz~max frequency	0.01Hz	<input type="radio"/>

When the setting frequency is within the range of hopping frequency, the actual running frequency will run in closer from the hopping frequency of the setting frequency. By setting the hopping frequency, can make the frequency converter to avoid the mechanical resonance point of load.

VD120 can be set up to two hopping frequency points, if the two hopping frequency are set to 0, then cancel the hopping frequency function. The principle of the hopping frequency and the hopping frequency range is as below.

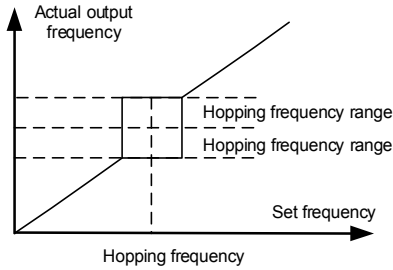

Fig 6-21 Schematic diagram of hopping frequency

Fb-15	Hopping Frequency Whether Valid in the Process of Acceleration and Deceleration	0: Disabled 1: Enabled	0	○
-------	---	---------------------------	---	---

The function code is used to set the hopping frequency during the process of acceleration and deceleration is valid.

When the setting is effective and the running frequency is in the range of hopping frequency, the actual running frequency will skip hopping frequency set boundary.

The following diagram is a schematic diagram of the hopping frequency effectively in the process of acceleration and deceleration.

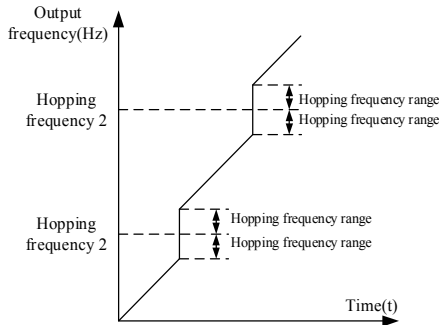

Fig 6-22 Effective schematic diagram of Hopping frequency in the process of acceleration and deceleration

Fb-16	Frequency Detection Value (FDT1)	0.00Hz~max frequency	50.00Hz	○
Fb-17	Frequency Detection Lagged Value (FDT1)	0.0%~100.0% (FDT1 electrical level)	5.0%	○
Fb-18	Frequency Detection Value (FDT2)	0.00Hz~max frequency	50.00Hz	○
Fb-19	Frequency Detection Lagged Value (FDT2)	0.0%~100.0% (FDT2 electrical level)	5.0%	○

When the running frequency is higher than the frequency detection values, the frequency converter

multi-function output DO output ON signal, and the frequency is lower than a certain frequency values of the detection values, the DO output ON signal is cancelled.

The above parameters are used to set the detection value of output frequency, and cancel the lag value of the output motion. The Fb-17 (Fb-19) is the percentage of lagging frequency relative to the frequency detection values Fb- 6 (Fb-18). The diagram below for the FDT function.

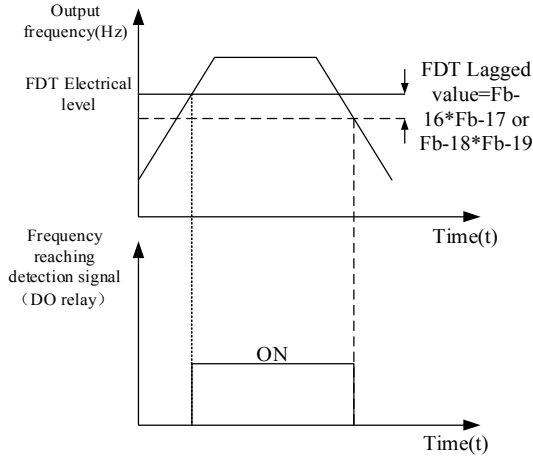

Fig 6-23 Schematic diagram of FDT electrical level

Fb-20	Frequency Reached Detection Amplitude	0.0%~100.0% (max frequency)	0.0%	○
-------	---------------------------------------	-----------------------------	------	---

The running frequency of the inverter, in a certain range of target frequency, inverter multi-function DO output ON signal.

This parameter is used to set the detection range of frequency reached, which is relative to the percentage of the maximum frequency. The diagram below is the frequency reached.

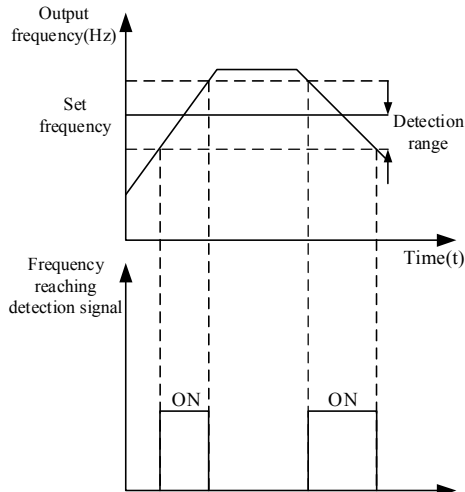

Fig 6-24 Schematic diagram of frequency reached detect amplitude

Fb-21	Any Frequency Reaching Detection Value 1	0.00Hz~max frequency	50.00Hz	○
Fb-22	Any Frequency Reaching Detection Amplitude 1	0.0%~100.0% (max frequency)	0.0%	○
Fb-23	Any Frequency Reaching Detection Value 2	0.00Hz~max frequency	50.00Hz	○
Fb-24	Any Frequency Reaching Detection Amplitude 2	0.0%~100.0% (max frequency)	0.0%	○

When the output frequency of frequency converter, in the range of positive and negative detection amplitude of the detection value at any time, multi-function DO output ON signal.

VD120 provides two sets of any frequency reaching detection parameters, set the frequency value and frequency detection range respectively. The diagram below is a diagram of the function.

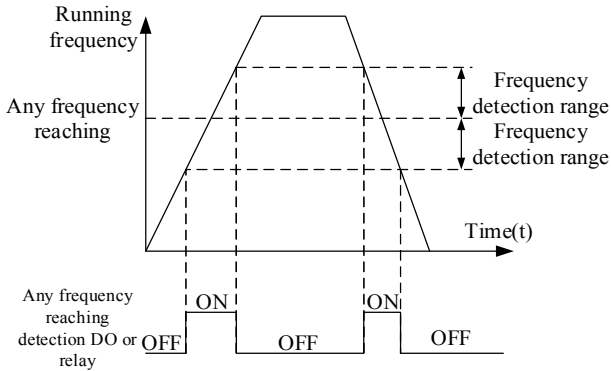

Fig 6-25 Schematic diagram of any frequency reaching detection

Fb-25	Zero Current Detection Levels	0.0%~300.0% 100.0% corresponding rated motor current	5.0%	○
Fb-26	Zero Current Detection Delay Time	0.01s~600.00s	0.10s	○

When the output current of the inverter is less than or equal to zero current detection level, and the duration is more than the zero current detection delay time, the inverter multi-function DO output ON signal. Below is the zero current detection schematic diagram.

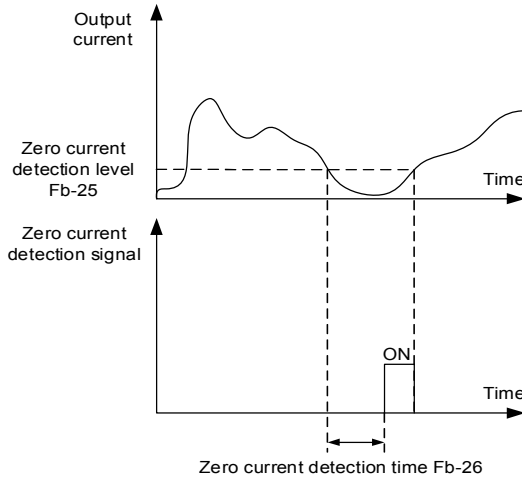

Fig 6-26 Schematic diagram of zero current detection

Fb-27	Output Current Limit Exceed	0.0% (no detection) 0.1%~300.0% (rated motor current)	200.0%	○
Fb-28	Output Current Limit Exceed Detection Delay Time	0.00s~600.00s	0.00s	○

When the output current of the inverter is greater than or limit exceed detection point, and the duration is more than the software overcurrent point detection delay time, inverter multi-function DO output ON signal, the following figure is the output current limit exceed function diagram.

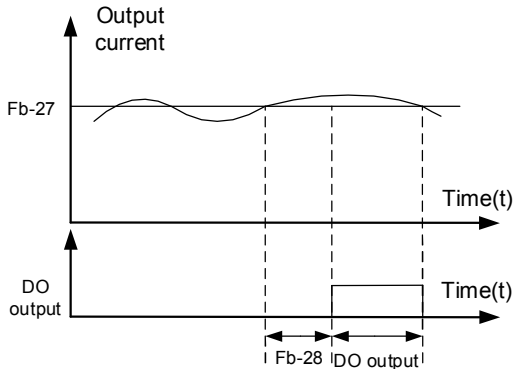

Fig 6-27 Schematic diagram of output current limit exceed detection

Fb-29	Any Current Reaching 1	0.0%~300.0% (rated motor current)	100.0%	○
Fb-30	Any Current Reaching 1 Amplitude	0.0%~300.0% (rated motor current)	0.0%	○
Fb-31	Any Current Reaching 2	0.0%~300.0% (rated motor current)	100.0%	○

Fb-32	Any Current Reaching 2 Amplitude	0.0%~300.0% (rated motor current)	0.0%	<input type="radio"/>
-------	----------------------------------	-----------------------------------	------	-----------------------

When the output current of frequency converter is set at the positive and negative detection amplitude of any current reaching, inverter multi-function the DO output ON signal.

VD120 provide two sets of any current reach and the detection amplitude parameter, the following figure is the function diagram.

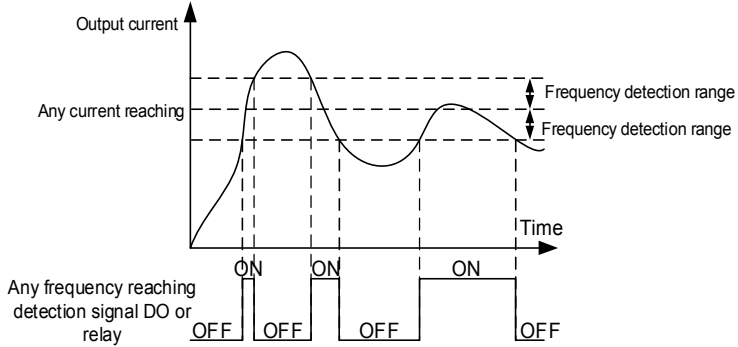

Fig 6-28 Schematic diagram of any current reaching detection

Fb-33	The Running Reached Time Setting	0.0Min~6500.0Min	0.0Min	<input type="radio"/>
-------	----------------------------------	------------------	--------	-----------------------

When the start of the run time reached this time, the frequency converter multi-function digital DO function output ON signal "current running time reached".

Fb-34	Accumulative Power-on Reached Time Setting	0h~65000h	0h	<input type="radio"/>
-------	--	-----------	----	-----------------------

Used to set the inverter power on time.

When the accumulative power on time (FF-15) reached the setting accumulative power on time, frequency converter multi-function digital DO output ON signal.

Fb-35	Accumulative Running Reached Time Setting	0h~65000h	0h	<input type="radio"/>
-------	---	-----------	----	-----------------------

Used to set the inverter running time.

When the accumulative running time (FF-14) reached the setting accumulative running time, inverter multi-function digital DO output ON signal.

Fb-36	Timing Function Selection	0: Disabled 1: Enabled	0	<input type="radio"/>
Fb-37	Timed Running Time Selection	0: Fb-38 setting 1: AI1 Analog input range corresponding to the Fb-38	0	<input type="radio"/>
Fb-38	Timed Running Function	0.0Min~65000.0Min	0.0Min	<input type="radio"/>

This group of parameters used to complete the timing run function of the inverter.

When Fb-36 timing function selection is effective, the inverter timing starts when it is started, to set timing run time, the inverter automatically stop, multi-function DO output ON signal at the same time.

Frequency converter starting at each time, timing starts from 0, timing remaining run time can be viewed by U0-35.

Timing run time set by Fb-37, Fb-38, unit of time for minutes.

Fb-39	Module Temperature Reached	0°C~100°C	75°C	○
-------	----------------------------	-----------	------	---

Inverter radiator temperature reached the temperature, the inverter multi-function DO output "module temperature reached" ON signal.

Fb-40	Lower Limit of AI1 Input Voltage Protection Value	0.00V~Fb-41	3.10V	○
Fb-41	Upper Limit of AI1 Input Voltage Protection Value	Fb-40~10.00V	6.80V	○

When the analog input AI1 value is less than Fb - 40, or the AI1 input is greater than Fb-41, the inverter multi-function the DO output "AI1 input limit exceed" ON signal, for indicating whether the input voltage of AI1 in the setting range.

Fb-42	Wakeup Frequency	Dormancy frequency (Fb-44)~max frequency (F0-10)	0.00Hz	○
Fb-43	Wakeup Delay Time	0.0s~6500.0s	0.0s	○
Fb-44	Dormancy Frequency	0.00Hz~wakeup frequency (Fb-42)	0.00Hz	○
Fb-45	Dormancy Delay Time	0.0s~6500.0s	0.0s	○

This set of parameters are used to realize the dormancy and wakeup function in water supply applications.

In the running process of frequency converter, when setting frequency less than or equal to Fb-44 dormancy frequency, after Fb-45 delay time, frequency converter to enter a dormant state, and automatically stop.

If the frequency converter in a dormant state, and the current running command is valid, then when setting frequency greater than or equal to Fb-42 wakeup frequency, and the frequency converter starts up after Fb-43 delay time.

In general, please set the wakeup frequency greater than or equal to dormancy frequency. Set the wakeup frequency and dormancy frequency is 0.00Hz, then dormancy and wakeup function is invalid.

In dormancy function is enabled, if frequency source use PID, the dormant state PID whether the arithmetic, influenced by function code FA-29, must be selected PID stop operation (FA-29=1) at this time.

Fb-48	Timing Braking Frequency	0.00Hz~50.00Hz	1.50Hz	○
Fb-49	Timing Braking Time	0.0s~60.0s	2.0s	○

In the process of stop, when the output frequency is less than the value of Fb-48, DO function 41 (timing brake) closed after output the set time of Fb-49. As shown in the figure below.

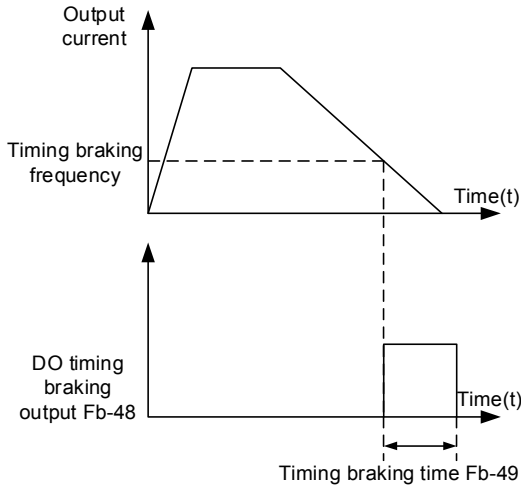

Fig 6-29 Schematic diagram of timing braking action

Fb-50	Terminal Jog Priority	0: Disabled 1: Enabled	1	<input type="radio"/>
-------	-----------------------	---------------------------	---	-----------------------

This parameter is used to set whether the highest priority of terminal jog function.

When the terminal jog priority is valid, if terminal jog command appeared in the process of running, the inverter switch to a terminal jog running state.

Fb-51	Swing Frequency Setting Method	0: Relative to center frequency 1: Relative to max frequency	0	<input type="radio"/>
-------	--------------------------------	---	---	-----------------------

Through this parameter to determine the benchmark of the swing.

0: relative center frequency (F0-05 frequency source), for variable amplitude system. The amplitude of the swing is varied with the change of the central frequency (setting frequency).

1: relative maximum frequency (F0-10), as the swing system, swing fixed.

Fb-52	Swing Frequency Amplitude	0.0%~100.0%	0.0%	<input type="radio"/>
Fb-53	Jumping Frequency Amplitude	0.0%~50.0%	0.0%	<input type="radio"/>

Through this parameter to determine the value of the amplitude and jumping frequency.

When setting swing relative to the center frequency (Fb-51=0), swing AW = frequency source F0-5 x swing amplitude Fb - 52. When setting swing relative to the maximum frequency (Fb-51=1), swing AW = maximum frequency F0-10 x swing amplitude Fb - 52.

Jumping frequency range for the swing frequency runtime, jumping frequency relative to the frequency percentage of the swing, i.e., jumping frequency=swing AW * jumping frequency amplitude Fb-53. If selection swing relative to the center frequency (Fb-51=0), jumping frequency is the variable value. If selection swing relative to the maximum frequency (Fb-51=1), jumping frequency is a fixed value.

Swing running frequency is constraints by the frequency upper limit and frequency lower limit.

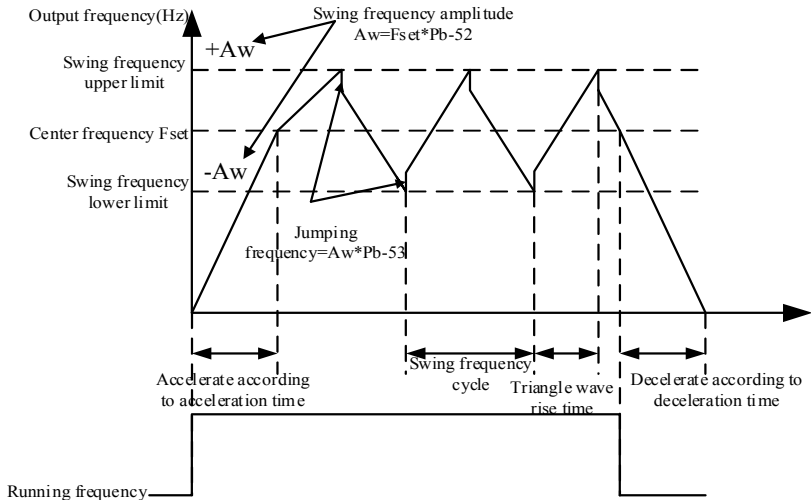

Fig 6-30 Schematic diagram of swing frequency function

Fb-54	Swing Frequency Cycle	0.1s~3000.0s	10.0s	○
Fb-55	Triangular Wave of Swing Frequency Rise Time	0.1%~100.0%	50.0%	○

Swing frequency cycle: a complete time value of swing frequency cycle.

Triangle wave rise time coefficient Fb-55, is a triangular wave rise time relative the time percentage of the swing frequency cycle Fb-54.

Triangle wave rise time=swing frequency cycle Fb-54 x triangle wave rise time coefficient Fb-55, and the unit is the second.

Triangle wave fall time=swing frequency cycle Fb-54 x (1-triangle wave rise time coefficient Fb-55), unit for seconds.

Fb-56	Set Length	0m~65535m	1000m	○
Fb-57	Actual Length	0m~65535m	0m	○
Fb-58	Number of Pulse per Meter	0.1~6553.5	100.0	○

The above function code is used to fixed-length control.

Length information need to be collect by the multi-function digital input terminals, terminal sampling pulse number and the number of pulses per meter Fb-58 division, can calculate the actual length Fb-57. When the actual length is greater than the set length Fb-56, multi-function digital DO output "length reached" ON signal.

In the process of the fixed length control, through the multi-function DI terminals, for the length of the reset operation (DI function selection for 47), specific please refer to the F5-00~F5-06.

In the application, need to set the corresponding input terminals function to "length counting input" (function 46), when the pulse frequency is higher, must use HDI1 port.

Fb-59	Set Count Value	1~65535	1000	○
Fb-60	Designated Count Value	1~65535	1000	○

Count value need to be collect by the multi-function digital input terminals. In the application, need to set the corresponding input terminals function to "counter input" (function 44), when the pulse frequency is higher, must use DI5/HD11 port.

When the count vale reached set count value Fb-59, multi-function digital DO output "set count value reached" ON signal, then the counter stop counting.

When the count value reached the designated count value Fb-60, multi-function digital DO output "designated count value reached" ON signal, and the counter continue to count, the counter stop until the " set count value".

Designated count value Fb-60 shall not be greater than set count value Fb-59. Below is the function diagram for set count value reached and designated count value reached.

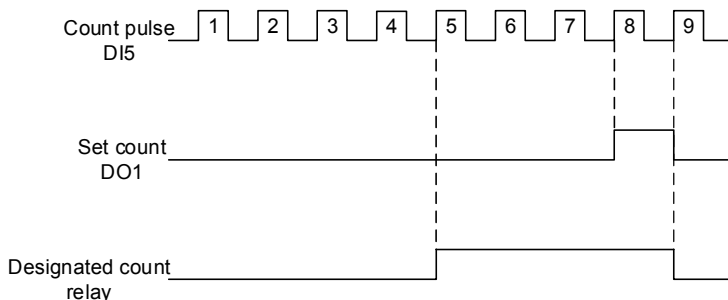

Fig 6-31 Schematic diagram of set count value and designated value

FC Multi-reference and Simple PLC Parameters Group

FC-00	Multi-reference 0	-100.0%~100.0%	0.0%	○
FC-01	Multi-reference 1	-100.0%~100.0%	0.0%	○
FC-02	Multi-reference 2	-100.0%~100.0%	0.0%	○
FC-03	Multi-reference 3	-100.0%~100.0%	0.0%	○
FC-04	Multi-reference 4	-100.0%~100.0%	0.0%	○
FC-05	Multi-reference 5	-100.0%~100.0%	0.0%	○
FC-06	Multi-reference 6	-100.0%~100.0%	0.0%	○
FC-07	Multi-reference 7	-100.0%~100.0%	0.0%	○
FC-08	Multi-reference 8	-100.0%~100.0%	0.0%	○
FC-09	Multi-reference 9	-100.0%~100.0%	0.0%	○
FC-10	Multi-reference 10	-100.0%~100.0%	0.0%	○
FC-11	Multi-reference 11	-100.0%~100.0%	0.0%	○
FC-12	Multi-reference 12	-100.0%~100.0%	0.0%	○
FC-13	Multi-reference 13	-100.0%~100.0%	0.0%	○
FC-14	Multi-reference 14	-100.0%~100.0%	0.0%	○
FC-15	Multi-reference 15	-100.0%~100.0%	0.0%	○

Multi-reference can be used in three occasions: as the frequency source, the voltage source of V/F separation and the set source of process PID.

Under three kinds of applications, the dimension of the multi reference is relative value, the range of -100.0%~100.0%, when as the frequency source it is relative to the percentage of the maximum frequency; when as the V/F separation voltage source, is relative to the percentage of the rated motor voltage; and because PID is given as a relative value, the multi-reference as set source of PID don't need a dimensional transformation. Multil-reference need according to the different status of multi-function digital DI, switch selection, specific please refer to the related instructions of F5 group.

FC-16	Simple PLC Run Mode	0: Stop when single run end 1: Keep the final value when single run end 2: Always circulation	0	○
-------	---------------------	---	---	---

Simple PLC has two functions: as frequency source or as a voltage source of V/F separation. The following figure is a simple PLC as the frequency source. When simple PLC as frequency source, the positive and negative of FC-00~FC-15 to determine the running direction, if the negative value indicates that the frequency inverter is running in the opposite direction.

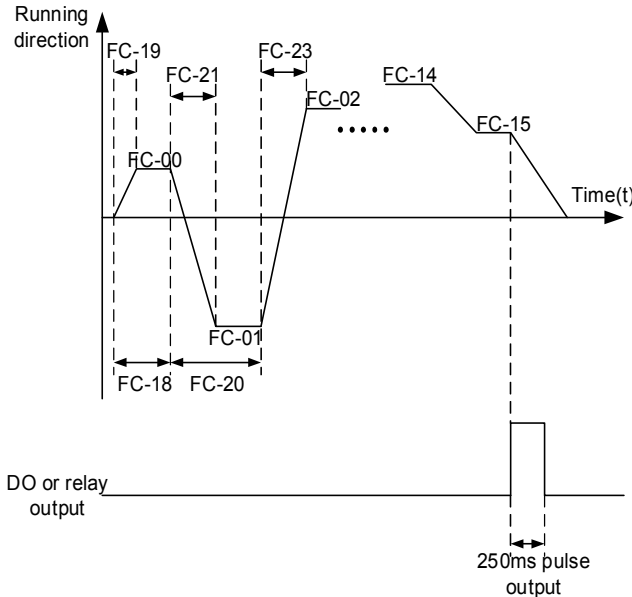

Fig 6-33 Schematic diagram of simple PLC

As a frequency source, PLC has three operation modes, as a V/F separation voltage source does not have this three ways. Among them:

0: Signal run end stop

After completing a single cycle inverter automatically stop, need operation command given to start again.

1: Single run end terminal

After completing a single cycle, inverter automatically keep the running frequency and direction of the last stage.

2: Always circulating

After completion of a cycle, the frequency inverter automatically starts the next cycle, until the stop command is stopped.

FC-17	Simple PLC Power Failure Retentive Selection	Unit's digit: power failure retentive selection 0: Non-retentive at power failure 1: Retentive at power failure Ten's digit: stop retentive selection 0: Non-retentive at stop 1: Retentive at stop	0x00	<input type="radio"/>
-------	--	--	------	-----------------------

PLC power failure retentive refers to the running stage and running frequency of PLC before the power failure retentive, the next time power on from memory stage to continue running. Selection non retentive, then each time power on to restart PLC process.

PLC stop retentive is records the running stage and running frequency of the previous PLC when power off, the next time running from memory stage to continue running. Selection non retentive, then each time start to restart PLC process.

FC-18	Run Time of Simple PLC Reference 0	0.0s (h)~6553.5s (h)	0.0s (h)	<input type="radio"/>
FC-19	Acceleration/Deceleration Time Selection of Simple PLC Reference 0	0~3	0	<input type="radio"/>
FC-20	Run Time of Simple PLC Reference 1	0.0s (h)~6553.5s (h)	0.0s (h)	<input type="radio"/>
FC-21	Acceleration/Deceleration Time Selection of Simple PLC Reference 1	0~3	0	<input type="radio"/>
FC-22	Run Time of Simple PLC Reference 2	0.0s (h)~6553.5s (h)	0.0s (h)	<input type="radio"/>
FC-23	Acceleration/Deceleration Time Selection of Simple PLC Reference 2	0~3	0	<input type="radio"/>
FC-24	Run Time of Simple PLC Reference 3	0.0s (h)~6553.5s (h)	0.0s (h)	<input type="radio"/>
FC-25	Acceleration/Deceleration Time Selection of Simple PLC Reference 3	0~3	0	<input type="radio"/>
FC-26	Run Time of Simple PLC Reference 4	0.0s (h)~6553.5s (h)	0.0s (h)	<input type="radio"/>
FC-27	Acceleration/Deceleration Time Selection of Simple PLC Reference 4	0~3	0	<input type="radio"/>
FC-28	Run Time of Simple PLC Reference 5	0.0s (h)~6553.5s (h)	0.0s (h)	<input type="radio"/>
FC-29	Acceleration/Deceleration Time Selection of Simple PLC Reference 5	0~3	0	<input type="radio"/>

FC-30	Run Time of Simple PLC Reference 6	0.0s (h)~6553.5s (h)	0.0s (h)	○
FC-31	Acceleration/Deceleration Time Selection of Simple PLC Reference 6	0~3	0	○
FC-32	Run Time of Simple PLC Reference 7	0.0s (h)~6553.5s (h)	0.0s (h)	○
FC-33	Acceleration/Deceleration Time Selection of Simple PLC Reference 7	0~3	0	○
FC-34	Run Time of Simple PLC Reference 8	0.0s (h)~6553.5s (h)	0.0s (h)	○
FC-35	Acceleration/Deceleration Time Selection of Simple PLC Reference 8	0~3	0	○
FC-36	Run Time of Simple PLC Reference 9	0.0s (h)~6553.5s (h)	0.0s (h)	○
FC-37	Acceleration/Deceleration Time Selection of Simple PLC Reference 9	0~3	0	○
FC-38	Run Time of Simple PLC Reference 10	0.0s (h)~6553.5s (h)	0.0s (h)	○
FC-39	Acceleration/Deceleration Time Selection of Simple PLC Reference 10	0~3	0	○
FC-40	Run Time of Simple PLC Reference 11	0.0s (h)~6553.5s (h)	0.0s (h)	○
FC-41	Acceleration/Deceleration Time Selection of Simple PLC Reference 11	0~3	0	○
FC-42	Run Time of Simple PLC Reference 12	0.0s (h)~6553.5s (h)	0.0s (h)	○
FC-43	Acceleration/Deceleration Time Selection of Simple PLC Reference 12	0~3	0	○
FC-44	Run Time of Simple PLC Reference 13	0.0s (h)~6553.5s (h)	0.0s (h)	○
FC-45	Acceleration/Deceleration Time Selection of Simple PLC Reference 13	0~3	0	○
FC-46	Run Time of Simple PLC Reference 14	0.0s (h)~6553.5s (h)	0.0s (h)	○

FC-47	Acceleration/Deceleration Time Selection of Simple PLC Reference 14	0~3	0	<input type="radio"/>
FC-48	Run Time of Simple PLC Reference 15	0.0s (h)~6553.5s (h)	0.0s (h)	<input type="radio"/>
FC-49	Acceleration/Deceleration Time Selection of Simple PLC Reference 15	0~3	0	<input type="radio"/>
FC-50	Simple PLC Run Time Unit	0: s 1: h	0	<input type="radio"/>
FC-51	Multi-reference 0 Setting Method	0: Coding FC-00 given 1: AI1 2: Reserved 3: Reserved 4: PULSE 5: PID 6: Preset frequency(F0-09)given, UP/DOWN can modify 7: Keypad potentiometer	0	<input type="radio"/>

This parameter decision the given channel of multi-reference 0.

In addition to FC-00, there are a variety of other options to convenient switching between multi-reference and other given way. When the multi-reference is used as a frequency source or simple PLC as a frequency source, can be easy to implement the switching between two kinds of frequency source.

FC-52	MS Speed Acceleration/Deceleration Time Selection Mode	0: Function code confirm 1: Terminal confirm	0	<input type="radio"/>
-------	--	---	---	-----------------------

Selection MS speed acceleration and deceleration time. Can be determined by the simple PLC corresponding to each of the acceleration and deceleration time, can also can 4 stage acceleration and deceleration time selected by the DI terminal (you can refer to the acceleration and deceleration time selection terminal functional specification in schedule 2 of F5 group).

Fd MODBUS Communication Parameter Group

Please refer to chapter 9 communication protocol.

FF User Parameters Group

FF-00	User Password	0:~65535	0	○
-------	---------------	----------	---	---

FF-00 set any non-zero number, and then the password protection function will be enabled.

When enter the menu next time, must input password correctly, otherwise can't view and modify the function parameters, please keep in mind that the user password is set.

Set FF-00 to 0000: then clear the user password set, and disable the password protection function.

FF-01	Parameter Initialization	0: No operation 1: Restore factory default setup value, exclude of motor parameter 2: Clear the record information 3: Backup user current parameters 4: Restore user current parameters	0	◎
-------	--------------------------	---	---	---

1. Restore the factory settings, not including motor parameters

After set the FF-01 to 1, most of frequency inverter function parameters restored to the factory parameters, but the motor parameters, the frequency instruction decimal point (F0-15), the fault recording information, the cumulative power consumption (FF-13), the cumulative power on time (FF-14), the total running time (FF-15) are not restored.

2. Clear the record information

To remove converter fault record information, cumulative power consumption (FF-13), cumulative power on time (FF-14), total running time (FF-15).

3. Backup user current parameters

Back up the parameters currently set by the user. Backup the current setting values of all the functional parameters. To facilitate the customer recovery after parameter adjustment disorder.

4. Restore user backup parameters

Restore the user parameters that backuped before, namely recovery by setting the FF-01 to 3 backup parameters.

FF-03	Function Code Display Selection	Unit's digit: 0: Not display A group 1: Display A group Ten's digit: 0: Not display b group 1: Display b group	0x11	○
-------	---------------------------------	---	------	---

The establishment of Parameters display mode is convenient for user to view the function parameters of different arrangement forms according to the actual needs.

FF-04	Function Code Modify Property	0: Can modify 1: Can't modify	0	○
-------	-------------------------------	----------------------------------	---	---

User Settings function code parameters whether can modify, used to prevent the risk of function parameter being change mistake.

The function code is set to 0, then all function code can be modified; while set to 1, all function code can only view, can't be modified.

FF-05	Fast Debugging Setting	Unit's digit: user custom parameter group display selection 0: Not display 1: Display Ten's digit: user change parameter group display selection 0: Not display 1: Display	0x10	○
-------	------------------------	---	------	---

When F7-00 selection for 5 (fast debugging) function, to set open or close the JOG/REV key by FF-05 can switch of three kinds of parameters display.

Name	Description
Function parameter mode	Order display function parameters and the frequency converter with F0 ~ FF, A0 ~ A4, b0 ~ b3, U0 function parameter set.
Custom parameters	Custom display function of the individual parameters (up to customize 32), the user need to display the function of the parameters were identified through the b0 group.
User change parameters mode	Different with the factory parameter function parameters.

When the fast debugging is effective, this time can through the JOG/REV key switch into a different parameter display mode, the default value for the function parameter mode display, the default can be switched to the users to change the parameter mode display.

Function display mode	Display
Function parameter display	-Func
Custom parameters display	-USEt
User change parameters display	----c

The display code of display mode of each parameters is:

VD120 inverter provides two groups of personality parameters display mode: the user to customize the parameters, the user to change the parameter.

User customization parameters group is set up to the parameter of b0 group, the maximum can selection 32 parameters, these parameters can be summarized together, and can be easy to debug.

Under customization parameter mode, default add a symbol of u before the user's custom function code.

For example: F0-01, in the user customization parameters, the display effect is uF0-01.

The user changes the parameters of the user to change the parameters that are different from the factory value. The user change parameter group is good for the customer to check the parameter summary of changes, and it is convenient for find problems at scene.

Users change the parameters, default add a symbol c before the user's custom function code.

For example F7-00, in the user to change the parameters, display effect is cF7-00.

FF-06	Product Code	0~65535	Factory Setting	●
FF-07	Software Versioning	1.00~10.00	Factory Setting	●
FF-08	Inverter Model		Factory Setting	●
FF-09	Date of Production (Year/Month)	0~9999	Factory Setting	●

FF-10	Date of Production (Date)	0~31	Factory Setting	●
-------	---------------------------	------	-----------------	---

Product information.

FF-11	Inverter Module Radiator Temperature	0°C~120°C	0	●
-------	--------------------------------------	-----------	---	---

Inverter module temperature.

FF-13	Accumulative Power Consumption	0°C~65535°C	0°C	●
-------	--------------------------------	-------------	-----	---

Show the inverter accumulative power consumption so far.

FF-14	Accumulative Running Time	0h~65535h	0h	●
-------	---------------------------	-----------	----	---

Display the accumulative running time of frequency converter since the factory.

When this time reach to set running time (Fb-35), inverter multi-function digital output function (30) output ON signal.

FF-15	Accumulative Power-on Time	0h~65535h	0h	●
-------	----------------------------	-----------	----	---

Display the accumulative power time of frequency inverter since the factory.

When this time reach to set running time (Fb-34), inverter multi-function digital output function (31) output ON signal.

FP Factory Parameter Group

Factory set parameters, users don't need to modify, forbidden user tries to enter the parametes group to view or modify any of the data, otherwise it will bring unexpected circumstances and even serious fault.

A0 Motor 1 Torque Control Parameter Group

A0-00	Speed/Torque Control Mode Selection	0: Speed control 1: Torque control	0	◎
-------	-------------------------------------	---------------------------------------	---	---

Used to select the inverter control mode: speed control or torque control.

VD120's multi-function digital DI terminal, have two function associated with torque control: torque control prohibit (function 40), speed control/torque control switch (function 39). The two terminals should be use in conjunction with A0-00 to realize the switch between speed and torque control.

When the speed control/torque control switch terminal is invalid, the control mode is determined by A0-00, if the speed control switch/torque control switch is effective, the control mode is equivalent to the value of A0-00.

In any case, the frequency inverter is fixed to the speed control mode when the torque control prohibit terminal is valid.

A0-01	Torque Setting Source Selection under the Torque Control Mode	0: Digital setting (A0-02) 1: AI1 2: Reserved 3: Reserved 4: PULSE 5: Communication setting 6: Reserved 7: Reserved 8: Keypad Potentiometer (the full scale of option 1~7 corresponding digital setting of A0-02)	0	⊙
A0-02	Torque Digital Setting under the Torque Control Mode	-200.0%~2000%	100.0%	○

A0-01 is used to select the torque setting source, a total of 8 kinds of torque setting method.

Torque setting use the relative value, and 100% corresponding the rated torque of the inverter. Set range -200.0%~200.0%, which shows that frequency inverter maximum torque of the 2 times the rated torque of the inverter.

When the torque is setting using 1~7, communication, analog input, and 100% of pulse input corresponding A0-02.

A0-03	Max Frequency Source Selection under the Torque Control Forward	0: Digital setting (A0-04) 1: AI1 2: Reserved 3: Reserved 4: PULSE 5: Communication setting 6: Keypad potentiometer	0	⊙
A0-04	Max Frequency Digital Setting under the Torque Control Forward	0.00Hz~max frequency	50.00Hz	○
A0-05	Max Frequency Source Selection under the Torque Control Reverse	0: Digital setting (A0-06) 1: AI1 2: Reserved 3: Reserved 4: PULSE 5: Communication setting 6: Keypad potentiometer	0	⊙
A0-06	Max Frequency Digital Setting under the Torque Control Reverse	0.00Hz~max frequency	50.00Hz	○

Used to set the forward or reverse maximum running frequency of the inverter under the torque control mode.

When the inverter torque control, if the load torque is less than the motor output torque, the motor speed will continue to rise, to prevent mechanical systems appear coasters and other accidents, must limit the motor highest speed when torque control.

A0-07	Torque Control Acceleration Time	0.00s~650.00s	0.00s	○
A0-08	Torque Control deceleration Time	0.00s~650.00s	0.00s	○

Under the torque control mode, the difference between the motor output torque and load torque, determine the speed change rate of the motor and load, so the speed of the motor can be changed quickly, which brings the problems such as high noise or mechanical stress. By setting the torque control acceleration and deceleration time, the motor speed can change smoothly.

But for the occasion need torque rapid response, you need to set the torque control acceleration and deceleration time is 0.00 s.

For example: two motor hard-wired drag the same load, in order to ensure the load uniform distribution, set a frequency inverter for the host, using the speed control mode, another inverter for the host and using torque control, the actual output torque of the host as the torque instructions of slave, the slave torque needs to quickly follow the host at this point, so the torque control acceleration and deceleration time of slave is 0.00s.

A0-09	Starting Torque Setting	0.0%~100.0%	10.0%	◎
A0-10	Excitation Current Coefficient under the Torque Control (only effective to SVC)	20.0%~150.0%	100.0%	◎

Torque control parameters, according to the actual situation to set the appropriate value.

A0-11	Low Frequency Torque Compensation Amount	0.0%~50.0%	0.0%	○
A0-12	Low Frequency Torque Compensation Frequency Upper Limit	0.00Hz~Max frequency	10.00Hz	○
A0-13	High Frequency Torque Compensation Amount	0.0%~50.0%	3.0%	○
A0-14	High Frequency Torque Compensation Frequency Lower Limit	0.00Hz~Max frequency	25.00Hz	○

The related parameters of the torque compensation, torque compensation for low frequency and high frequency, stable output.

A0-15	Rotational Inertia Compensation Reference	0: Internal frequency 1: Feedforward frequency variation 2: Feedforward frequency	1	◎
A0-16	Feedforward Frequency Source Selection	0: A11 1: Reserved 2: Reserved 3: PULSE 4: Communication setting	0	◎
A0-17	Rotational Inertia Compensation Coefficient	0.00~10.00	0.00	○

A0-18	Rotational Inertia Compensation Upper Limit	0.0%~50.0%	5.0%	<input type="radio"/>
A0-19	Rotational Inertia Compensation Starting Frequency	0.00Hz~max frequency	10.00Hz	<input type="radio"/>
A0-20	Lowest Resolution Frequency (only effective to SVC)	0.00: Not limit 0.01Hz~2.00Hz	1.00Hz	<input type="radio"/>

The related parameters of the rotational inertia, generally do not need to adjust.

A0-21	Disconnection Detection Time	0.0: Disconnection is invalid 0.1~60.0s	0.0	<input type="radio"/>
-------	------------------------------	--	-----	-----------------------

Disconnection detection time is set to zero, the line detection function is effective, when the actual output frequency reaches (upper limit frequency -0.5Hz), the duration exceeds the set break detection time, reported Err.22 (disconnection detection fault).

AI Optimize Control Parameter Group

A1-00	Carrier Frequency	0.5kHz~16.0kHz	Model dependent	<input type="radio"/>
-------	-------------------	----------------	-----------------	-----------------------

This function is used to adjust the carrier frequency of the inverter. By adjusting the carrier frequency can reduce motor noise and avoid the resonance point of mechanical system, reduce the line of floor drain current and reducing interference caused by frequency inverter.

When the carrier frequency is low, the output current harmonic component increases, motor loss increases, the temperature rise of the motor increases.

When the carrier frequency is high, the motor loss is decreases, the motor temperature decreases, but the inverter loss increases, the inverter temperature rise, and the interference increases.

Adjusting the carrier frequency will affect the following performance.

Carrier frequency	Low → High
Motor noise	Big → Small
Output current waveform	Bad → Good
Motor s temperature rising	High → Low
Inverter temperature rising	Low → High
Leakage current	Small → Big
External radiated interference	Small → Big

Different power inverter, the factory settings of carrier frequency are different. Although the user can modify according to the need, but need to pay attention: if the carrier frequency is higher than the factory value, will lead to frequency inverter radiator temperature rise, at this time the user needs to use the frequency converter derating, otherwise the inverter has the risk of overheating alarm.

A1-01	Carrier Frequency Adjustment with the Temperature	0: No 1: Yes	1	<input type="radio"/>
-------	---	-----------------	---	-----------------------

Carrier frequency adjustment with the temperature, is refers to the frequency inverter is detected its radiator at high temperature, reduce the carrier frequency automatically, in order to reduce the frequency inverter temperature rise. When the radiator at low temperature, carrier frequency is

gradually restored to the setting value. This function can reduce the chance of inverter overheat alarm.

A1-02	DPWM Switching Frequency Upper Limit	0.00Hz~15.00Hz	12.00Hz	○
-------	--------------------------------------	----------------	---------	---

Only valid for V/F control.

The wave mode determined by the asynchronous machine V/F running, which is lower than the value of the 7 stage continuous modulation mode, on the contrary is the 5 stage intermittent modulation mode.

The switching loss of the inverter is relatively large when for the 7 stages continuous modulation, but the current ripple is small; switch loss is small under 5 stage intermittent modulation mode, the current ripple is larger, may lead to the instability of the motor running at high frequency, generally do not need to modify.

Please refer to the function code F4-11 about V/F running is not stable, on the loss and temperature rising of the inverter please refer to the function code A1-00.

A1-03	PWM Modulation Mode	LED unit's digit: 0: Asynchronous modulation 1: Synchronous modulation LED ten's digit: 0: Two phase and three phase modulation 1: Three phase modulation	0x00	◎
-------	---------------------	--	------	---

Only valid for V/F control.

Synchronization modulation, refers to the carrier frequency linear changes with the output frequency change to ensure that both ratio (carrier ratio) not change, generally used in the output frequency is higher, is conducive to the quality of the output voltage.

At low output frequency (below 100Hz), it is generally not required to be synchronized modulation, because the ratio of carrier frequency and the output frequency is high, the asynchronous modulation advantages is more obvious.

When the running frequency is higher than 85Hz, the synchronization modulation is effective, the frequency of the following fixed for asynchronous modulation mode.

A1-04	Dead Zone Compensation Mode Selection	0: Without compensation 1: Compensation 1 2: Compensation 2	1	○
-------	---------------------------------------	---	---	---

Generally do not need to modify the parameters, only in the quality of the output voltage waveform have special requirements, or the motor is abnormal oscillation, such as motor, need to try to switch to select different compensation mode.

High-power is recommended for use with compensation mode 2.

A1-05	Random PWM Depth	0: Random PWM invalid 1~10: PWM carrier frequency random depth	0	○
-------	------------------	---	---	---

Set up random PWM, can make the motor sound of the monotonous grating becomes more soft, and can help for to reduce the external electromagnetic interference.

When the random PWM depth is 0, the random PWM is invalid. Adjust the random PWM different depth will get different results.

A1-06	Rapid Current Limiting Enable	0: Disable 1: Enable	1	<input type="radio"/>
-------	-------------------------------	-------------------------	---	-----------------------

Use rapid current limiting function, can maximum limit reduce inverter appear overcurrent fault, ensure the inverter uninterrupted running.

If the frequency inverter in rapid current limiting condition for a long time, frequency inverter could overheat and other damage, this situation is not allowed, so the frequency inverter will alarm fault Err. 38 when for a long time fast current limiting, said inverter overload and need to stop.

A1-07	Current Detection Compensation	0~100	5	<input type="radio"/>
-------	--------------------------------	-------	---	-----------------------

Used to set the current detection compensation of inverter, set too large may lead to a decrease in control performance.

Generally do not need to modify.

A1-08	SVC Optimize Mode Selection	0: Optimize 0 1: Optimize 1 2: Optimize 2	1	<input checked="" type="radio"/>
-------	-----------------------------	---	---	----------------------------------

Optimize mode 1: used when have higher torque control linearity requirements.

Optimize mode 2: used when have high speed stability requirement.

A1-09	Dead Zone Time Adjustment	100%~200%	150%	<input type="radio"/>
-------	---------------------------	-----------	------	-----------------------

Aimed at 1140V voltage level setting.

Adjustment this value can improve the effective utilization of voltage, adjustment is too small easy to cause system unstable.

Don't suggest the user to change.

A1-10	Droop Control	0.00Hz~10.00Hz	0.00Hz	<input type="radio"/>
-------	---------------	----------------	--------	-----------------------

This function is commonly used for load distribution when multi motors are by drive the same load.

Droop control refers to with the increase of load, make the inverter output frequency drops, so when multi motors drive the same load, the motor output frequency of the load drop more, thus can reduce the load of the motor, realize the load distribution of multi motors.

This parameter refers to the frequency inverter in the rated output load, the decline in value of the output frequency.

A1-11	Cooling Fan Control	0: Fan operation in runtime 1: Fan is always running	0	<input checked="" type="radio"/>
-------	---------------------	---	---	----------------------------------

Used to select the action mode of cooling fan, selection for 0, the fan running when the inverter in running state or if the radiator temperature is higher than 40 degrees in stop state, and doesn't work when radiator less than 40 degrees in stop state.

When selection for 1, the fan operation after power on.

A1-12	Speed Identification Filter Depth	0~8	4	<input checked="" type="radio"/>
A1-13	Low Frequency Carrier Limit Mode	0: Limit mode 1 1: Limit mode 2 2: Not Limit	0	<input type="radio"/>

Optimization parameter, generally do not need to modify.

b0 User Customize Function Code

b0-00	User Code 0		F0-00	○
b0-01	User Code 1		F0-01	○
b0-02	User Code 2		F0-02	○
b0-03	User Code 3		F0-09	○
b0-04	User Code 4		F0-18	○
b0-05	User Code 5		F0-19	○
b0-06	User Code 6		F4-00	○
b0-07	User Code 7		F4-01	○
b0-08	User Code 8		F5-01	○
b0-09	User Code 9		F5-02	○
b0-10	User Code 10		F5-03	○
b0-11	User Code 11		F6-02	○
b0-12	User Code 12		F6-03	○
b0-13	User Code 13		FF-06	○
b0-14	User Code 14		FF-06	○
b0-15	User Code 15		FF-06	○
b0-16	User Code 16		FF-06	○
b0-17	User Code 17		FF-06	○
b0-18	User Code 18		FF-06	○
b0-19	User Code 19		FF-06	○
b0-20	User Code 20		FF-06	○
b0-21	User Code 21		FF-06	○
b0-22	User Code 22		FF-06	○
b0-23	User Code 23		FF-06	○
b0-24	User Code 24		FF-06	○
b0-25	User Code 25		FF-06	○
b0-26	User Code 26		FF-06	○
b0-27	User Code 27		FF-06	○
b0-28	User Code 28		FF-06	○
b0-29	User Code 29		FF-06	○

b0-30	User Code 30		FF-06	○
b0-31	User Code 31		FF-06	○

This function code is the users customize parameter group.

Users can in all VD120 function code, select the needed parameter summary to b0 group, as the user customization parameters, convenient to view and change such as operation.

b0 group most provide 31 users customize parameter, b0 group parameter display value is F0.00, said the user function code is empty.

Enter the users customize parameter mode, the display code defined by b0-00~b0-31, order consistent with b0 group function code, will skip when for F0-00.

b1 Virtual IO Parameter Group

b1-00	Virtual VDI1 Terminal Function Selection	0~59	0	⊙
b1-01	Virtual VDI2 Terminal Function Selection	0~59	0	⊙
b1-02	Virtual VDI3 Terminal Function Selection	0~59	0	⊙
b1-03	Virtual VDI4 Terminal Function Selection	0~59	0	⊙
b1-04	Virtual VDI5 Terminal Function Selection	0~59	0	⊙

Virtual VDI1~VDI5 are exactly the same when the control panel DI on the function, can be used as a multi-function digital quantity input, the detail setting please refer to the introduce of F5-00~F5-09.

b1-05	Virtual VDI Terminal State Setting Mode	Unit's digit: virtual VDI1 0: By virtual VDOx state to decide VDI is valid or not 1: By code b1-06 setting VDI is valid or not Ten's digit: virtual VDI2, same as above Hundred's digit: virtual VDI3, same as above Thousand's digit: virtual VDI4, same as above Ten thousand's digit: virtual VDI5, same as above	0x00000	⊙
b1-06	Virtual VDI Terminal state setting	Unit's digit: virtual VDI1 0: Disabled 1: Enabled Ten's digit: virtual VDI2, same as above Hundred's digit: virtual VDI3, same as above Thousand's digit: virtual VDI4, same as above Ten thousand's digit: virtual VDI5, same as above	0x00000	⊙

Different from ordinary digital quantity input terminals, the state of the virtual VDI can set two ways, and selection by b1-05.

When selecting VDI status is decided by the state of the corresponding virtual VDO, VDI whether is valid state, depending on the VDO output as valid or invalid, and the VDIx only binding VDOx (x is 1~5).

When selection VDI status are setting by the function code, through the binary system of function code b1-06, determine the status of the virtual input terminals respectively.

The following illustrates the use method of virtual VDI.

Example 1: when selecting VDO state decided to VDI, to complete the following functions: "AI1 input beyond the upper and lower limit, frequency inverter fault alarm and stop", can use the following setting method:

Set VDI1 function to "user-defined failure 1" (b1-00 = 50);

Set VDI1 terminal valid state model for determine by VDO1 (b1-05 = xxx0);

Set VDO1 output function as "AI1 input beyond the upper and lower limit" (b1-11= 37);

When AI1 input beyond the upper and lower limit, the VDO1 output is ON state, the VDI1 input terminal state is valid, inverter VDI1 receives the user-defined failure 1, the inverter will fault alarm Err. 35 and stop.

Example 2: when selecting function code b1-06 set VDI state, to complete the following functions: "after inverter power on, automatically enter the running state", can use the following setting method:

Set VDI1 function to " forward running " (b1-00=1);

Set VDI1 terminal valid state mode is setting for function code (b1-05=xxx1);

Set VDI1 terminal status for valid (b1-06=xxx1);

Set the command source for "terminal control" (F0-01=1);

After inverter power on and finished initialization, detect VDI1 is effective, and the terminal corresponding to forward running, equivalent to a frequency inverter receives a terminal forward running command, frequency inverter immediately began to forward running.

b1-07	Function Selection when AI1 Terminal as DI	0~59	0	⊙
b1-10	Effective Mode Selection when AI1 Terminal as DI	0: High electrical level enable 1: Low electrical level enable	0	⊙

As the group function code is used to AI used as DI, when AI used as DI, when the AI input voltage is greater than 7V, AI terminal state for high level, when the AI input voltage is lower than 3V, AI terminal state for low level. Between 3V~7V for hysteresis AI-10 when used to determine the AI as DI, AI high level state for valid state, or the low level for valid state.

As for AI as the function set of DI, same as the ordinary DI settings, please refer to the instructions of F5 group related DI setup.

The following figure is take AI input voltage as an example, explain the relationship between AI input voltage and the corresponding DI state.

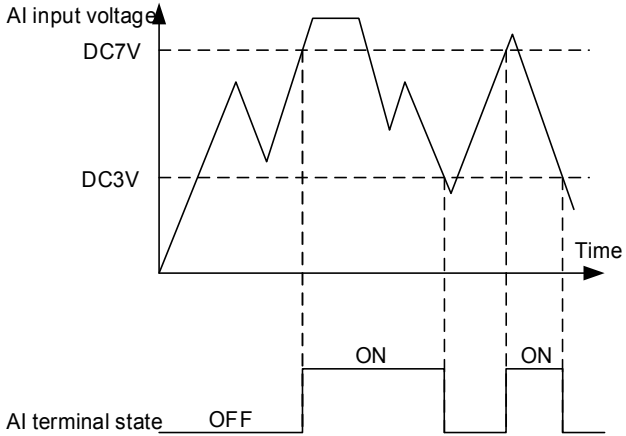

Fig 6-33 AI terminal effective state judgment

b1-11	Virtual VDO1 Output Function Selection	0: Short circuit with physical DIX internal 1~43: see the F6 group physical DO output selection	0	○
b1-12	Virtual VDO2 Output Function Selection	0: Short circuit with physical DIX internal 1~43: see the F6 group physical DO output selection	0	○
b1-13	Virtual VDO3 Output Function Selection	0: Short circuit with physical DIX internal 1~43: see the F6 group physical DO output selection	0	○
b1-14	Virtual VDO4 Output Function Selection	0: Short circuit with physical DIX internal 1~43: see the F6 group physical DO output selection	0	○
b1-16	VDO1 Closing Delay	0.0s~3600.0s	0.0s	○
b1-17	VDO2 Closing Delay	0.0s~3600.0s	0.0s	○
b1-18	VDO3 Closing Delay	0.0s~3600.0s	0.0s	○
b1-19	VDO4 Closing Delay	0.0s~3600.0s	0.0s	○
b1-20	VDO5 Closing Delay	0.0s~3600.0s	0.0s	○

b1-21	VDO Output Terminal Effective State Selection	Unit's digit: VDO1 0: Positive logic 1: Anti-logic Ten's digit: VDO2, same as above Hundred's digit: VDO3, same as above Thousand's digit: VDO4, same as above Ten thousand's digit: reserved	0x00000	○
b1-22	VDO1 Disconnection Delay	0.0s~3600.0s	0.0s	○
b1-23	VDO2 Disconnection Delay	0.0s~3600.0s	0.0s	○
b1-24	VDO3 Disconnection Delay	0.0s~3600.0s	0.0s	○
b1-25	VDO4 Disconnection Delay	0.0s~3600.0s	0.0s	○
b1-26	VDO5 Disconnection Delay	0.0s~3600.0s	0.0s	○

Virtual digital output function, similar to the control panel DO output function, can be used to cooperate with virtual digital quantity input VDIX, implement some simple logic control.

When virtual VDOx output function selection for 0, the output state of VDO1~VDO4 determined by DI1~DI4 input status on the control panel, VDOx and Dix one to one corresponding at this point.

When virtual VDOx output function selection for not zero, the function setting and use methods of VDOx is the same with the F6 group DO output related parameters, please refer to the related parameters of the F6 group.

The same output valid state of the VDOx can selection positive logic or antilogic, setting through the b1-10.

In VDIX application example, including the use of VDOx, please reference.

b2 AI Curve Setting Parameter Group

b2-00	AI Curve 4 Min Input	-10.00V~b2-02	0.00V	<input type="radio"/>
b2-01	Corresponding Setting of AI Curve 4 Min Input	-100.0%~+100.0%	0.0%	<input type="radio"/>
b2-02	AI Curve 4 Inflection Point 1 Input	b2-00~b2-04	3.00V	<input type="radio"/>
b2-03	Corresponding Setting of AI Curve 4 Inflection Point 1 Input	-100.0%~+100.0%	30.0%	<input type="radio"/>
b2-04	AI Curve 4 Inflection Point 2 Input	b2-00~b2-06	6.00V	<input type="radio"/>
b2-05	Corresponding Setting of AI Curve 4 Inflection Point 2 Input	-100.0%~+100.0%	60.0%	<input type="radio"/>
b2-06	AI Curve 4 Max Input	b2-06~+10.00V	10.00V	<input type="radio"/>
b2-07	Corresponding Setting of AI Curve 4 Max Input	-100.0%~+100.0%	100.0%	<input type="radio"/>
b2-08	AI Curve 5 Min Input	-10.00V~b2-10	-10.00V	<input type="radio"/>
b2-09	Corresponding Setting of AI Curve 5 Min Input	-100.0%~+100.0%	-100.0%	<input type="radio"/>
b2-10	AI Curve 5 Inflection Point 1 Input	b2-08~b2-12	-3.00V	<input type="radio"/>
b2-11	Corresponding Setting of AI Curve 5 Inflection Point 1 Input	-100.0%~+100.0%	-30.0%	<input type="radio"/>
b2-12	AI Curve 5 Inflection Point 2 Input	b2-10~b2-14	3.00V	<input type="radio"/>
b2-13	Corresponding Setting of AI Curve 5 Inflection Point 2 Input	-100.0%~+100.0%	30.0%	<input type="radio"/>
b2-14	AI Curve 5 Max Input	b2-12~+10.00V	10.00V	<input type="radio"/>
b2-15	Corresponding Setting of AI Curve 5 Max Input	-100.0%~+100.0%	100.0%	<input type="radio"/>

The function of curve 4 and 5 are similar with curve 1~3, but the curve 1~3 is a straight line, while the curve 4 and 5 is 4 point curve, can realize more flexible corresponding relation. The diagram below is curve 4~5.

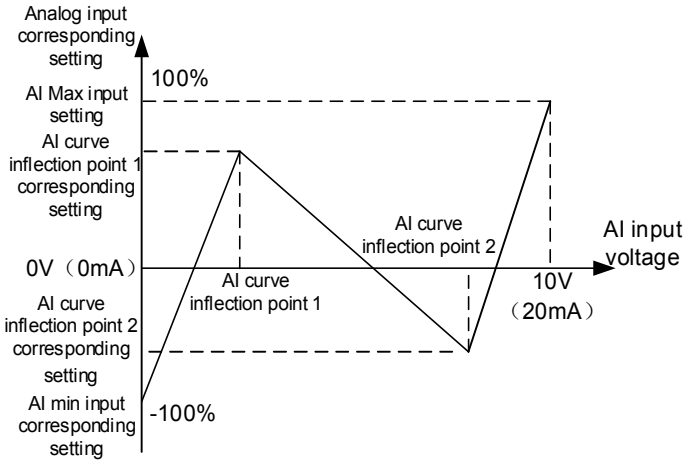

Fig 6-34 Schematic diagram of curve 4 and curve 5

Must be noticed when setting curve 4 and 5, the minimum input voltage, inflection point 1 voltage, inflection point 2 voltage and maximum voltage of curve must be increased in turn.

AI curve selection F5-20, used to determine the analog input AI1, AI2 how to select between 5 curves.

b2-16	AI1 Setting Jump Point	-100.0%~100.0%	0.0%	<input type="radio"/>
b2-17	AI1 Setting Jump Range	0.0%~100.0%	0.5%	<input type="radio"/>
b2-18	AI2 Setting Jump Point	-100.0%~100.0%	0.0%	<input type="radio"/>
b2-19	AI2 Setting Jump Range	0.0%~100.0%	0.5%	<input type="radio"/>
b2-20	AI3 Setting Jump Point	-100.0%~100.0%	0.0%	<input type="radio"/>
b2-21	AI3 Setting Jump Range	0.0%~100.0%	0.5%	<input type="radio"/>

All the analog input AI1 and AI2 of VD120 have set value jump function.

Jump function refers to, when analog set corresponding changes within the range of jump point up and down, to fix analog corresponding value for the jumping point value.

Such as:

The voltage of analog input AI1 fluctuates up and down in 5.00V, the range is 4.90V to 5.10V, the minimum input 0.00V of AI1 is 0.0%, the maximum input 10.00V is 100%, then the detected AI1 set corresponding fluctuation between 49.0%~51.0%.

Set AI1 setting jump point b2-16 is 50.0%, set the AI1 setting jump range b2-17 is 1.0%, when the above AI1 input, after the jump function processing, get the AI1 input corresponding set to 50.0%, AI1 is transformed into a steady input, eliminates the fluctuations.

b3 AIO Correction Parameter Group

b3-00	AI1 Measured Voltage 1	0.500V~4.000V	Factory Correction	<input type="radio"/>
b3-01	AI1 Displayed Voltage 1	0.500V~4.000V	Factory Correction	<input type="radio"/>
b3-02	AI1 Measured Voltage 2	6.000V~9.999V	Factory Correction	<input type="radio"/>
b3-03	AI1 Displayed Voltage 2	6.000V~9.999V	Factory Correction	<input type="radio"/>

The group function code is used to correct the analog input AI to eliminate the influence of zero bias and gain of AI input port.

The group function parameters has been corrected before factory, when restore the factory, will revert to the values after factory correction. Generally don't need to be corrected at the scene of the application.

The measured voltage refers to the actual voltage measure by the multimeter and other measurement instruments, display voltage refers to the voltage display value of frequency inverter sampling, as shown in U0 group AI voltage before correction (U0-21, U0-22).

When correction, input two voltage value in each input port of AI, and put the value measure by multimeter and the value reads by U0 group respectively accurate into the above function code, the inverter will automatically carry out the zero bias and gain correction of AI.

b3-12	AO1 Target Voltage 1	0.500V~4.000V	Factory Correction	<input type="radio"/>
b3-13	AO1 Measured Voltage 1	0.500V~4.000V	Factory Correction	<input type="radio"/>
b3-14	AO1 Target Voltage 2	6.000V~9.999V	Factory Correction	<input type="radio"/>
b3-15	AO1 Measured Voltage 2	6.000V~9.999V	Factory Correction	<input type="radio"/>

The group function code, used to correct the analog output AO.

The group function parameters has been corrected before factory, when restore the factory, will revert to the values after factory correction. Generally don't need to be corrected at the scene of the application.

Target voltage is refers to the theory output voltage value of inverter. The measured voltage refers to the actual voltage measure by the multimeter and other measurement instruments.

U0 Basic Monitoring Parameters Group

Code	Parameter Name	Display Value	Display Unit	Property
U0-00	Running Frequency (Hz)		0.01Hz	●
U0-01	Set Frequency (Hz)		0.01Hz	●
U0-02	Bus Voltage (V)		0.1V	●
U0-03	Output Voltage (V)		1V	●
U0-04	Output Current (A)		0.01A	●
U0-05	Output Power (kW)		0.1kW	●
U0-06	Output Torque (%)		0.1%	●
U0-07	DI Input State		1	●
U0-08	DO Input State		1	●
U0-09	AI1 Voltage (V)		0.01V	●
U0-10	AI2 Voltage (V)		0.01V	●
U0-11	Reserved			●
U0-12	Count Value		1	●
U0-13	Length Value		1	●
U0-14	Load Speed Display		1	●
U0-15	PID Setting		1	●
U0-16	PID Feedback		1	●
U0-17	PLC Stage		1	●
U0-18	Input PULSE Frequency (kHz)		0.01 kHz	●
U0-19	Feedback Speed (0.1Hz)		0.1Hz	●
U0-20	Setting Torque		0.1%	●
U0-21	AI1 Voltage before Correction		0.001V	●
U0-22	Reserved			●
U0-23	Reserved			●
U0-24	Line Speed		1m/Min	●
U0-25	Current Power on Time		1Min	●
U0-26	Current Running Time		0.1Min	●
U0-27	Input PULSE Frequency		1Hz	●

U0-28	Communication Setting Value		0.01%	●
U0-29	Reserved			●
U0-30	Main Frequency A display		0.01Hz	●
U0-31	Auxiliary Frequency B Display		0.01Hz	●
U0-32	View Any Memory Address Value		1	●
U0-35	Surplus Running Time		0.1Min	●
U0-36	Reserved			●
U0-37	Power Factor Angle		0.1°	●
U0-38	Reserved			●
U0-39	VF Separation Target Voltage		1V	●
U0-40	VF Separation Output Voltage		1V	●
U0-41	Visual Display DI Input State		1	●
U0-42	Visual Display DO Input State		1	●
U0-43	Visual Display DI Function State 1 (Function 01~40)		1	●
U0-44	Visual Display DI Function State 2 (Function 41~80)		1	●
U0-45	Current Fault State		1	●
U0-46	Torque Compensation Amount		0.1%	●

Chapter 7 EMC Guide

7.1 Definition

Electromagnetic compatibility is the ability of the electric equipment to run in the electromagnetic interference environment and implement its function stably without interferences on the electromagnetic environment.

7.2 EMC Standard Introduction

VD120 inverters have pass CE Test and is conformed to the requirements of the standard IEC/EN61800-3: 2004.

IEC/EN61800-3 assesses the inverter in terms of electromagnetic interference and Anti electromagnetic interference. Electromagnetic interference mainly tests the radiation interference, conduction interference and harmonics interference on the inverter (required for the inverter for civil use) Anti-electromagnetic interference mainly tests the conduction immunity, radiation immunity, surge interference immunity, rapid mutation pulse group immunity, ESD immunity and low frequency of power supply immunity.

7.3 EMC Guide

During inverter installation and usage, please comply to details of this chapter, in general industry environment it has good electromagnetic compatibility.

7.3.1 Harmonic Effect:

Higher harmonics of power supply may damage the inverter. Thus, at some places where power quality is rather poor, it is recommended to install AC input reactor.

7.3.2 Electromagnetic Interference and Installation Precautions

There are two kinds of electromagnetic interferences, one is interference of electromagnetic noise in the surrounding environment on the inverter, and the other is interference of inverter on the surrounding equipment.

Installation precautions:

- 1) The earth wires of the inverter and other electric products shall be well grounded;
- 2) The power input and output power cables of the inverter and weak current signal cables (e.g. control line) shall not be arranged in parallel and vertical arrangement is preferable.
- 3) It is recommended that the output power cables of the inverter employ shield cables or steel pipe shielded cables and that the shielding layer be earthed reliably. The lead cables of the equipment suffering interferences are recommended to employ twisted-pair shielded control cables, and the shielding layer shall be earthed reliably.
- 4) When the length of motor cable is longer than 100 meters, it needs to install output filter or reactor.

7.3.3 Handling Method for the Interferences of the Surrounding Equipment on the Inverter

The electromagnetic interference on the inverter is generated because plenty of relays, contactors and electromagnetic braking are installed near the inverter. When the inverter has error action due to the interferences, the following measures can be taken:

- 1) Install surge suppressor on the devices generating interference;
- 2) Install filter at the input end of the inverter. Refer to Section 7.3.6 for the specific operations.
- 3) The lead cables of the control signal cable of the inverter and the detection line employ shielded cable and the shielding layer shall be earthed reliably.

7.3.4 Handling Method for the Interferences of Inverter on the Surrounding Equipment

These interferences include two types: one is radiation interference of the inverter, and the other is conduction interference of the inverter. These two types of interferences cause the surrounding electric equipment to suffer electromagnetic or electrostatic induction. The surrounding equipment hereby produces error action. For different interferences, it can be handled by referring to the following methods:

- 1) For the measuring meters, receivers and sensors, their signals are generally weak. If they are

placed nearby the inverter or together with the inverter in the same control cabinet, they are easy to suffer interference and thus generate error actions. It is recommended to handle with the following methods: Put in places far away from the interference source; do not arrange the signal cables with the power cables in parallel and never bind them together; both the signal cables and power cables employ shielded cables and are well earthed; install ferrite magnetic ring (with suppressing frequency of 30 to 1, 000MHz) at the output side of the inverter and wind it 2 to 3 cycles; install EMC output filter in bad conditions;

2) When the equipment suffering interferences and the inverter use the same power supply, it may cause conduction interference. If the above methods cannot remove the interference, it shall install EMC filter between the inverter and the power supply (refer to Section for the prototyping operation);

3) The surrounding equipment is separately earthed, which can avoid the interference caused by the leakage current of the inverter's earth wire when common earth mode is adopted.

7.3.5 Leakage Current and Disposal

Inverter leakage current has two types: one is to ground leakage current, one is line-to-line leakage current.

1) The factors of affecting to ground leakage current and solution:

the conducting cable and earth has distributed capacitance, the bigger the capacitance is, the bigger the leakage current is, so by effectively shorten the distance between motor and inverter can reduce distributed capacitance. The bigger the carrier frequency is, the bigger the leakage current is. By reducing carrier frequency to reduce leakage current, but reducing carrier frequency will result in motor noise increasing. Please pay attention: add electric reactor is also an effective way to solve leakage current. The leakage current will increase as the increase of loop circuit current. So if motor power is big, the corresponding leakage current is big.

2) The factors resulting in line-to-line leakage current and solution:

There is distributed capacitance among inverter output wirings, if the passing current has higher harmonic, it may result in resonance and bring leakage current. If using thermal relay might result in wrong action. The solution is to reduce carrier frequency or add output electric reactor. In application, it is not recommended to add thermal relay between motor and inverter, but to use inverter electronic overcurrent protection function.

7.3.6 Notice for Power Input Side adding EMC Input Filter

WARNING

- When using the filter, please follow its rated values strictly. Since the filter belongs to Classification I electric appliances, the metal enclosure of the filter shall be large and the metal ground of the installing cabinet shall be well earthed and have good conduction continuity. Otherwise there may be danger of electric shock and the EMC effect may be greatly affected.
- Through the EMC test, it is found that the filter ground must be connected with the PE end of the inverter at the same public earth. Otherwise the EMC effect may be greatly affected.
- The filter shall be installed at a place close to the input end of the power supply as much as possible.

Chapter 8 Fault Shooting and Solutions

8.1 Fault Alarm and Countermeasures

VD120 inverter has warning information and fault protection function. In case of abnormal fault, the inverter error relay contactor will be in action, before user seeking for help, please do self-inspection according to this chapter to analyze causes and find out solution. If user cannot solve problem by himself, seeking for help or directly contact your local dealer or our company.

VD120 inverter during running process or powered on, if fault occurred, on the display of panel of inverter will show error code. At the moment inverter already have protection effectively to the fault, output terminal stopped output, the display panel has indicating current error with 2~5 code.

Inverter keypad displayer has showing error code when in error, the code content and corrective action as below table.

Code	Error type	Possible error causes	Solution
Err.01	Acceleration overcurrent (hardware)	<ol style="list-style-type: none"> 1. Acceleration time is too short 2. Motor parameter is not correct 3. Grid voltage is too low 4. Inverter power is too small 5. V/F curve inappropriate 6. Inverse module short circuit protection 	<ol style="list-style-type: none"> 1. Extend acceleration time 2. Self-tuning to motor parameter 3. Check grid input power 4. Select inverter with bigger power class 5. Adjust V/F curve setting, adjust manual torque boost 6. Inverter module or drive circuit damage
Err.02	Deceleration overcurrent (hardware)	<ol style="list-style-type: none"> 1. Deceleration time is too short 2. load inertia torque is too big 3. Inverter power is too small 4. Inverse module short circuit protection 	<ol style="list-style-type: none"> 1. Extend deceleration time 2. Add external energy consumption braking unit 3. Select inverter with bigger class power 4. Inverse module or drive circuit damage
Err.03	Constant speed overcurrent (hardware)	<ol style="list-style-type: none"> 1. Load with jump or abnormal 2. Grid voltage is too low 3. Inverter power is too small 4. Inverse module short circuit protection 	<ol style="list-style-type: none"> 1. Check load or reduce load jumping 2. Check grid input power 3. Select inverter with bigger class power 4. Inverse module or drive circuit damage
Err.04	Acceleration overcurrent (software)	<ol style="list-style-type: none"> 1. Acceleration time is too short 2. Motor parameter is not correct 3. Grid voltage is too low 4. Inverter power is too small 5. V/F curve inappropriate 	<ol style="list-style-type: none"> 1. Extend acceleration time 2. Self-tuning to motor parameter 3. Check grid input power 4. Select inverter with bigger power class 5. Adjust V/F curve setting, adjust manual torque boost

Err.05	Deceleration overcurrent (software)	<ol style="list-style-type: none"> 1. Deceleration time is too short 2. Load inertia torque is too big 3. Inverter power is too small 	<ol style="list-style-type: none"> 1. Extend deceleration time 2. Add external energy consumption braking unit 3. Selection inverter with bigger class power
Err.06	Constant speed overcurrent (software)	<ol style="list-style-type: none"> 1. Load with jump or abnormal 2. Grid voltage is too low 3. Inverter power is too small 	<ol style="list-style-type: none"> 1. Check load or reduce load jumping 2. Check grid input power 3. Selection inverter with bigger class power
Err.07	Acceleration overvoltage	<ol style="list-style-type: none"> 1. The inverter output circuits exist grounding short circuit 2. The control model is vector and has no parameter identification 3. Low voltage 4. Whether there is a sudden load in running 5. Small frequency inverter selection 	<ol style="list-style-type: none"> 1. Eliminate outside faults 2. Doing motor parameter identification 3. Set the voltage to normal range 4. Cancel the sudden load 5. Selection inverter with bigger class power
Err.08	Deceleration overvoltage	<ol style="list-style-type: none"> 1. High input voltage 2. In the process of acceleration, there is an extant force to drive the motor running 3. Acceleration time is too short 4. No installation brake unit and brake resistor 	<ol style="list-style-type: none"> 1. Set the voltage to the normal range 2. Cancel the external power or installation brake resistance 3. Increase the acceleration time 4. Installation brake unit and resistor
Err.09	Constant speed overvoltage	<ol style="list-style-type: none"> 1. High input voltage 2. In the process of deceleration, there is an extant force to drive the motor running 3. Deceleration time is too short 4. No installation brake unit and brake resistor 	<ol style="list-style-type: none"> 1. Set the voltage to the normal range 2. Cancel the external power or installation brake resistance 3. Increase the deceleration time 4. Installation brake unit and resistor
Err.10	Undervoltage	<ol style="list-style-type: none"> 1. Instantaneous power failure 2. The voltage of the inverter input is not in the scope of the specification requirements 3. Bus voltage is not normal 4. Rectifier bridge and buffer resistance is not normal 5. Driven board abnormal 6. Control panel abnormal 	<ol style="list-style-type: none"> 1. Reset fault 2. Adjust the voltage to normal range 3. Seeking technical support 4. Seeking technical support 5. Seek technical support 6. Seeking technical support

Err.11	Motor overload	<ol style="list-style-type: none"> 1. Motor protection parameters F8-01 set whether appropriate 2. Whether the load is too large or motor stalling 3. Small frequency converter selection 	<ol style="list-style-type: none"> 1. Check the power grid voltage 2. Reset the rated motor current 3. Check the load, adjust the torque boost
Err.12	Inverter overload	<ol style="list-style-type: none"> 1. Whether the load is too large or motor stalling 2. Small frequency converter selection 	<ol style="list-style-type: none"> 1. Reduce the load and check the motor and mechanical conditions 2. Selection inverter with bigger class power
Err.13	Input side phase loss	<ol style="list-style-type: none"> 1. Three-phase input power is not normal 2. Drive board abnormal 3. Lightning protection plate abnormal 4. Main control board abnormal 	<ol style="list-style-type: none"> 1. Check and eliminate the problems existing in the peripheral circuit 2. Seeking technical support 3. Seeking technical support 4. Seeking technical support
Err.14	Output side phase loss	<ol style="list-style-type: none"> 1. The lead of inverter to motor is not normal 2. Inverter three-phase output imbalance when motor running 3. Driven board abnormal 4. Module abnormal 	<ol style="list-style-type: none"> 1. Eliminate peripheral failure 2. Check the motor three-phase winding is normal and troubleshooting 3. Seeking technical support 4. Seeking technical support
Err.15	Module overheat	<ol style="list-style-type: none"> 1. Environment temperature is too high 2. Air duct blockage 3. Fan damage 4. Module thermal resistance damage 5. Inverter module damage 	<ol style="list-style-type: none"> 1. Reduce the environmental temperature 2. Clean air duct 3. Replace the fan 4. Replace the thermal resistance 5. Replace the inverter module
Err.17	External fault	<ol style="list-style-type: none"> 1. Through the multi-function terminal DI input external fault signal 2. Through the virtual IO function input external fault signal 	<ol style="list-style-type: none"> 1. Reset running 2. Reset running
Err.18	Communication fault	<ol style="list-style-type: none"> 1. The PC work is not work 2. Communication line is not normal 3. Communication expansion card F0-23 set is not correct 4. Communication parameter Fd group is not correct 	<ol style="list-style-type: none"> 1. Check the PC connection line 2. Check the communication connection line 3. Correctly set up communication expansion card type 4. Correctly set communication parameters
Err.19	Current detection abnormal	<ol style="list-style-type: none"> 1. Check the hall device abnormal 2. Driver board abnormal 	<ol style="list-style-type: none"> 1. Replace the hall device 2. Replace the driver board

Err.20	Motor self-learning abnormal	<ol style="list-style-type: none"> 1. The motor parameters not set according to the nameplate 2. The parameter identification process timeout 	<ol style="list-style-type: none"> 1. Correctly set motor parameters according to the nameplate 2. Check the inverter to motor lead
Err.21	EEPROM write-read abnormal	<ol style="list-style-type: none"> 1. EEPROM chip damage 	<ol style="list-style-type: none"> 1. Replace main control board
Err.22	Disconnection detection fault	<ol style="list-style-type: none"> 1. Output disconnection 2. The upper limit frequency setting is too small of A0-21 setting time is too short 3. When do not need to disconnection detection, A0-21 set nonzero value, and the actual output frequency reaches the upper limit frequency 	<ol style="list-style-type: none"> 1. Rewinding 2. The upper limit frequency application or A0-21 set reasonable value 3. Set A0-21 to zero
Err.23	PID feedback loss when running	<ol style="list-style-type: none"> 1. PID feedback less than FA-26 set value 	<ol style="list-style-type: none"> 1. Check the PID feedback signal or set the FA-26 to an appropriate value
Err.24	Motor short circuit to ground	<ol style="list-style-type: none"> 1. One phase (U, V, W) short circuit to ground 	<ol style="list-style-type: none"> 1. Replace the cable or motor
Err.27	Running time reached	<ol style="list-style-type: none"> 1. Accumulative running time reach to set value 	<ol style="list-style-type: none"> 1. Using parameter initialization function to clear the record information
Err.28	Power on time reached	<ol style="list-style-type: none"> 1. Accumulative power on time reach to set value 	<ol style="list-style-type: none"> 1. Using parameter initialization function to clear the record information
Err.29	Buffer contactor overheating	<ol style="list-style-type: none"> 1. Power grid voltage fluctuation range is too large, cause the inverter repeatedly up and down, buffer contactor overheating 	<ol style="list-style-type: none"> 1. Adding input reactor and other measures to ensure the stability of input voltage
Err.35	User self-define fault 1	<ol style="list-style-type: none"> 1. Through the multi-function terminal DI input the signal of user-defined fault 1 2. Through the virtual IO function input the signal of user-defined fault 1 	<ol style="list-style-type: none"> 1. Reset running 2. Reset running
Err.36	User self-define fault 2	<ol style="list-style-type: none"> 1. Through the multi-function terminal DI input the signal of user-defined fault 2 2. Through the virtual IO function input the signal of user-defined fault 2 	<ol style="list-style-type: none"> 1. Reset running 2. Reset running

Err.37	Offload	1. The inverter running current is less than F8-16	1. Confirm whether the load is out of or F8-16, F8-17 parameter settings are consistent with the actual running condition
Err.38	Rapid current-limiting timeout	1. Whether the load is too large or motor stalling 2. Small frequency converter selection	1. Reduce the load and check the motor and mechanical conditions 2. Selection inverter with bigger class power
Err.39	Switch motor when running	1. In the process of inverter running through the terminal to change the current motor selection	1. Switch motor operation after inverter stop
Err.43	Manufacturer self-define fault		1. Seeking service

8.2 Common Faults and Solutions

8.2.1 No Display after Power On

Inspect whether the input power supply of inverter is the same as the inverter rated voltage or not with multi-meter. If the power supply has problem, inspect and solve it. Inspect whether the three-phase rectify bridge is in good condition or not. If the rectification bridge is burst out, ask for support.

Check the CHARGE light on. If the light is off, the fault is mainly in the rectify bridge or the buffer resistor. If the light is on, the fault may be lies in the switchover power supply. Please ask for support.

8.2.2 Power Supply Air Switchover Trips off When Power On

Inspect whether the input power supply is grounded or short circuit. Please solve the problem. Inspect whether the rectify bridge has been burnt or not. If it is damaged, ask for support.

8.2.3 Motor doesn't Move after Inverter Run

Inspect if there is balanced three-phase output among U, V, W. If yes, then motor could be damaged, or mechanically locked. Please solve it. If the output is unbalanced or lost, the inverter drive board or the output module may be damaged, ask for support..

8.2.4 Inverter Displays Normally when Power On, but Switchover at the Input Side Trips when Run

- ① Inspect whether the output side of inverter is short circuit. If yes, ask for support.
- ② Inspect whether ground fault exists. If yes, solve it.
- ③ If trip happens occasionally and the distance between motor and inverter is too far, it is recommended to install output AC reactor.
- ④ If inverter in normal protection, after eliminating error, press STOP/RESET key to reset error, then restart inverter.
- ⑤ After eliminating error, inverter power supply shut down, wait until LED display light off, then restart inverter.
- ⑥ If above steps cannot get inverter back to normal usage, then take note of the error code displayed, and inverter specification, product number, then contact the manufacturer.

Chapter 9 Communication Protocol

VD120 series inverter, providing RS-485 communication interface, using the international standard Modbus-RTU format communication protocol for the master-slave communication. The user can realize the centralized control by PC/PLC, controlling the host computer and so on (setting the frequency inverter control order, the running frequency, the related function code parameter revision, frequency inverter working condition and fault information monitoring and so on), adapts the specific application request.

9.1 About Protocol

This Modbus serial communication protocol defines the frame content of asynchronous transmission information and use format in the series communication and it includes master-polling (or broadcast address) executive command, data and error checking. The response of slave is the same structure, and it includes action confirmation, returning the data and error checking etc. If slave takes place the error while it is receiving the information or cannot finish the action demanded by master, it will send one fault signal to master as a response.

9.2 Application Methods

VD120 series inverter will be connected into a "Single-master Multi-slave" control net with RS485 bus.

9.3 Bus Structure

(1) Interface mode RS-485 Hardware interface.

(2) Transmission mode

There provide asynchronous series and half-duplex transmission mode. At the same time, just one can send the data and the other only receives the data between master and slave. In the series asynchronous communication, the data is sent out frame by frame in the form of message.

(3) Topological mode

In Single-master system, the setup range of slave address is 1 to 247. Zero refers to broadcast communication address. The address of slave must be exclusive in the network. That is the basis to guarantee the Modbus serial communication.

9.4 Protocol Description

VD120 series inverter communication protocol is a kind of serial master-slave communication protocol, in the network, only one equipment (master) can build a protocol. (Named as "Inquire/Command"). Other equipment (slave) only by providing the data response "Inquire/Command" or doing the action according to the master's "Inquiry/Command". Here, master is personnel computer (PC), industrial control machine or programmable logical controller(PLC) etc., and the slave refers to the VD120 series inverter or other control equipment with the same communication protocol. Master not only visits some slave, but also sends the broadcast information to all the slaves. For the single master "Inquiry/Command", all of slaves will return a signal that is a response; for the broadcast information provided by master, slave needs not feedback a response to master machine.

9.5 Communication Frame Structure

VD120 series inverter Modbus protocol communication data format is divided into RTU (remote terminal unit) mode.

In RTU mode, each byte has the following format:

Encoding system: 8-bit binary, each 8-bit frame field, including two hexadecimal characters, hexadecimal 0 ~ 9, A ~ F.

Data format: start bit, 8 data bits, parity bit and stop bit. The data format is described in the following table: In RTU mode, new frames are always started with a transmission time silence of at least 3.5 bytes. In the calculation of the transmission rate to the baud rate on the network, the transmission time of 3.5 bytes can be easily grasped. Followed by the transmission of data fields are: slave address, operation command code, data and CRC checksum, each field transfer bytes are hexadecimal 0... 9, A ... F. The network device always monitors the activity of the communication bus.

When the first field (address information) is received, each network device acknowledges the byte. With the completion of the last byte transfer, there is a similar 3.5 byte transmission time interval, used to identify the end of this frame, after which, will start a new frame transmission.

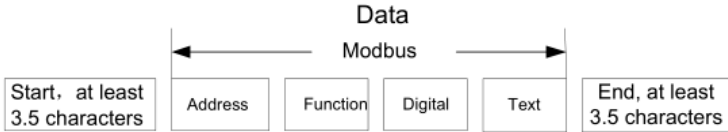

The information of a frame must be transmitted in a continuous data stream. If there is more than 3.5 bytes of interval time before the end of the entire frame transmission, the receiving device will clear the incomplete information and erroneously assume that the next byte is new similarly, if the interval between the start of a new frame and the previous frame is less than 3.5 bytes, the receiving device will consider it to be the continuation of the previous frame. Because of the frame disorder, the final CRC Check the value is not correct, resulting in communication failure.

The standard structure of RTU frame:

Frame header START	T1-T2-T3-T4(3.5 Bits transmission time)
Slave address field ADDR	Communication address: 0~247(decimal) (0 as broadcast address)
Function field CMD	03H: read slave parameter 06H: write slave parameter
Data field DATA (N-1)...DATA (0)	2*N Bit data: this part is the main content of communication, also as the core of data exchange in communication
CRC CHK low Bit	Detect value: CRC verify value (16Bit)
CRC CHK high Bit	
Tail Frame END	T1-T2-T3-T4 (3.5 Bits transmission time)

9.6 Command Code and Communication Data Description

9.6.1 Command code: 03H (0000 0011), reads N words. (There are 16characters can be read at the most.)

For example: the inverter slave address is 01H, memory start address is 1001H (running frequency address), read 5Bits continuously (running frequency, bus voltage, output voltage, output current, output power total 5 data of run parameter), the frame of structure as below:

RTU master command message

START	T1-T2-T3-T4
ADDR	01H
CMD	03H
Start address high Bit	10H
Start address low Bit	01H
Data Bit high Bit	00H
Data Bit low Bit	05H
CRCCHK low Bit	D0H

CRCCHK high Bit	C9H
END	T1-T2-T3-T4

RTU slave reponse information

When Fd-05=0

START	T1-T2-T3-T4
ADDR	01H
CMD	03H
Number of bytes	10H
Running frequency high Bit	xxH
Running frequency low Bit	xxH
Bus voltage high Bit	xxH
Bus voltage low Bit	xxH
Output voltage high Bit	xxH
Output voltage low Bit	xxH
Output current high Bit	xxH
Output current low Bit	xxH
Output power high Bit	xxH
Output power low Bit	xxH
CRCCHK low Bit	xxH
CRCCHK high Bit	xxH
END	T1-T2-T3-T4

When Fd-05=1

START	T1-T2-T3-T4
ADDR	01H
CMD	03H
Number of bytes high Bit	00H
Number of bytes low Bit	10H
Running frequency low Bit	xxH
Running frequency high Bit	xxH
Bus voltage high Bit	xxH
Bus voltage low Bit	xxH
Output voltage high Bit	xxH
Output voltage low Bit	xxH

Output current high Bit	xxH
Output current low Bit	xxH
Output power high Bit	xxH
Output power low Bit	xxH
CRCCHK low Bit	xxH
CRCCHK high Bit	xxH
END	T1-T2-T3-T4

9.6.2 Command Code: 06H (0000110), write one word

Such as: Put 1000 (2710H) (namely write-in setting frequency $F0-10*100\%$) write to slave address 01H to the 1000H of the inverter (communication set value address). The frame structure description as below:

RTU Master command information.

START	T1-T2-T3-T4
ADDR	01H
CMD	06H
Write data address high Bit	10H
Write data address low Bit	00H
Data content high Bit	27H
Data content low Bit	10H
CRCCHK low Bit	97H
CRCCHK high Bit	36H
END	T1-T2-T3-T4

RTU slave response information.

START	T1-T2-T3-T4
ADDR	01H
CMD	06H
Write data address high Bit	10H
Write data address low Bit	00H
Data content high Bit	27H
Data content low Bit	10H
CRCCHK low Bit	97H
CRCCHK high Bit	36H
END	T1-T2-T3-T4

9.6.3 Communication Format Error Check Method

Frame error check mode includes two part verification, Bit check of byte (odd/even verify) and CRC

check of complete data of format.

9.6.3.1 Byte check

User can select different check mode according to requirement, can also select no-check, but it will affect the Bit setting of every byte check.

The meaning of even check: add a Bit of even parity check before data transmission, to express the number of "1" in the transmission data is odd or even, if the number is even, check Bit is "0", otherwise it is set to "1" to Keep the parity of the data unchanged.

The meaning of odd check: add a Bit of odd parity check before data transmission, to express the number of "1" in the transmission data is odd or even, if the number is odd, check Bit is "0", otherwise it is set to "1". to Keep the parity of the data unchanged.

For example, the transmitting data "11001110", there is 5 "1" in the data, if using even parity check, the even check Bit is "1", if using odd parity check, the odd check Bit is "0", when transmitting data, the parity check Bit will be processed and put at the position of format check Bit. And the receiving device will also do parity check, if it found the parity of the received data is not the same as pre-set, then it decides that communication was in error.

9.6.3.2 CRC check method

Use the RTU frame format, format include format error-checking field that is based on CRC method calculation. The CRC field checks the contents of the entire format. The CRC field has two bytes , containing a 16-Bit binary value. It is calculated by the transmission device to be added to the frame. The receiving device recalculates the CRC of the received frame and compares it with the value in the received CRC field. If the two CRC values are not equal, then the transmission has an error.

The CRC saves 0xFFFF at first, then call a process to deal with the successive 6 bytes of the format and the value of present register. Only the 8Bit data of each byte is enabled for CRC, the starting Bit and the end Bit and parity check Bit is all disabled.

During generation of the CRC, each 8-bit character is separate from the register contents or (XOR), the results is shifting towards the lowest enabled Bit, the highest enabled Bit is filled with 0. LSB is extracted to be checked, if LSB is 1, the register separate and preset values different or (XOR); if LSB is 0, then no need. The complete process will be repeated for 8times. After completing of the last Bit (the 8th Bit), the next 8-bit byte is separate or (XOR)from the current value of the register. The final value of register is the CRC value of the all Bit executed of the frame.

The calculation of CRC, adopting the international standard CRC check regulation, when user is editing CRC calculation, can relevant standard CRC algorithm to write the CRC calculation process of truly meet the requirements.

Now provides a simple function of the CRC calculation to the user reference (C language programming).

```

unsigned int crc_cal_value(unsigned char *data_value ,unsigned char data_length)
{
    int i;
    unsigned int crc_value=0xFFFF;
    while(data_length-->0)
    {
        crc_value^=*data_value++;
        For(i=0;i<8;i++)
        {
            iF(crc_value&0x0001)
                crc_value=(crc_value>>1)^0xa001;
            else
                crc_value=crc_value>>1;
        }
    }
}

```

```

    }
  }
  return(crc_value);
}

```

In logic ladder, CKSM calculates CRC value according to frame content, adopting table look-up method, this method is simple in program, quick calculating speed, but with big occupying ROM space. Please consider carefully in application with requirement on program space.

9.6.4 Communication Data Address Definition

This part is the content of the communication, used to control the operation of the inverter, inverter status and related parameters setting.

Read and write functional code parameter (some function code which can not be changed, only for the use or monitoring of manufacturers) :

Function code parameter address label rules:

The rule representation of function code group number and label for the parameter address:

High byte:F0~FF (group F), A0-AF (group A), B0-BF (group B), 70-7F (group U) low byte: 00 to FF
 Such as: F3-12, address represented as F30C;

Note:

FP groups: neither read the parameters, and do not change the parameters;

U group: only can read, do not change the parameters.

When some parameters in converter is in operation, do not change; some parameters of the frequency converter in any state, cannot be changed; change function code parameters, but also pay attention to the range, units, and related instructions of parameters.

In addition, since the EEPROM is frequently stored, the service life of the EEPROM is reduced, so some function code under the mode of communication, do not need to store, just change the value of RAM.

If to F group of parameters, in order to realize the function, as long as this function code address high F into 0 can be achieved.

If for A group of parameters, in order to realize the function, the function code as long as the address of A high into 4 can be achieved.

Corresponding function code shown by the following address:

High byte: 00~0F (group F), 40~4F (group A), 50~5F (group b)

Low byte: 00 to FF

Such as:

Function code F3-12 is not stored in the EEPROM, address for 030C;

Function code A0-05 is not stored in the EEPROM, address for 4005;

The address that can only do write RAM, can not do the action read, as invalid address when reading.

For all the parameters, can also use the command code 07H to implement this feature.

Stop/run parameters section:

Communication Address	Communication Content	Read-write Property (RW)
1000H	Communication set value (-10000~10000) (decimal)	RW
1001H	Running frequency	R
1002H	Bus voltage	R
1003H	Output voltage	R

1004H	Output current	R
1005H	Output power	R
1006H	Output torque	R
1007H	Running speed	R
1008H	DI input sign	R
1009H	DO output sign	R
100AH	AI1 voltage	R
100BH	Reserved	R
100CH	Reserved	R
100DH	Count value input	R
100EH	Length value input	R
100FH	Load speed	R
1010H	PID setting	R
1011H	PID feedback	R
1012H	PLC step	R
1013H	PULSE input pulse frequency, unit 0.01kHz	R
1014H	Feedback speed, unit 0.1Hz	R
1015H	Surplus running time	R
1016H	AI1 voltage before correction	R
1017H	Reserved	R
1018H	Reserved	R
1019H	Linear speed	R
101AH	Current power on time	R
101BH	Current running time	R
101CH	HDI1 input pulse frequency, unit 1Hz	R
101DH	Communication set value	R
101EH	Actual feedback speed	R
101FH	Main frequency A display	R
1020H	Auxiliary frequency B display	R

Note:

The communication set value is a percentage of the relative value, 10000 corresponds to 100.00% and -10000 corresponds to -100.00%.

Data on frequency dimensional, the percentage is a percentage of relative maximum frequency (F0-10); for torque dimensional data, this percentage is F3-10 (torque upper limit digital setting).

Control command input to the inverter: (only write)

Command address	Command function
2000H	0001H: Forward running
	0002H: Reverse running
	0003H: Forward jog
	0004H: Reverse jog
	0005H: Coast to stop
	0006H: Decelerate to stop
	0007H: Fault reset
	0008H: Emergency stop

Read inverter state: (only read)

State Word Address	State Function
3000H	0001H: Forward running
	0002H: Reverse running
	0003H: Stop

Parameters lock password check: (if return for 8888 h, it indicates that the password through check)

Code Address	Input content of the password
1F00H	*****

Digital output terminal control: (only write)

Command Address	Command Content
2001H	BIT0: Reserved BIT1: Reserved BIT2: RELAY1 BIT3: Reserved BIT4: DO1 BIT5: VDO1 BIT6: VDO2 BIT7: VDO3 BIT8: VDO4 BIT9: VDO5

Analog output AO1 control: (only write)

Command Address	Command Content
2002H	0~7FFF indicate 0%~100%

Pulse output control: (only write)

Command Address	Command Content
2004H	0~7FFF indicate 0%~100%

Inverter fault description:

Inverter fault address	Inverter fault information
8000H	0000H: no fault 0001H: acceleration over current (hardware) 0002H: deceleration over current (hardware) 0003H: constant over current (hardware) 0004H: acceleration over current (software) 0005H: deceleration over current (software) 0006H: constant over current (software) 0007H: acceleration over voltage 0008H: deceleration over voltage 0009H: constant over voltage 000AH: overvoltage 000BH: motor overload 000CH: inverter overload 000DH: input phase loss 000EH: output phase loss 000FH: module overheat 0010H: reserved 0011H: external fault 0012H: communication abnormal 0013H: current detection abnormal 0014H: motor debugging abnormal 0015H: EEPROM read-write abnormal 0016H: reserved 0017H: PID feedback lost when running 0018H: short-circuit to ground upon motor 0019H: reserved 001AH: reserved 001BH: running time reach 001CH: power on time reach 001DH: reserved 001EH: reserved 001FH: reserved 0020H: reserved 0021H: reserved 0022H: reserved 0023H: user-defined failure 1 0024H: user-defined failure 2 0025H: offload 0026H: fast current limit timeout 0027H: reserved 0028H: reserved 0029H: reserved 002AH: reserved 002BH: user-defined failure

Communication fault information description date (fault code):

Communication fault address	Fault function description
-----------------------------	----------------------------

8001	0000: no fault 0001: password erro 0002: command code erro 0003: CRC check erro 0004: invalid address 0005: invalid parameter 0006: parameter change is invalid 0007: system is lock 0008: in EEPROM operation
------	--

Fd MODBUS Communication

Fd-00	Baud Rate	0: 300BPS 1: 600BPS 2: 1200BPS 3: 2400BPS 4: 4800BPS 5: 9600BPS 6: 19200BPS 7: 38400BPS 8: 57600BPS 9: 115200BPS	5	○
-------	-----------	---	---	---

This parameter is used to set data transfer rate between the PC and inverter. Note that the host computer and the baud rate set by the inverter must be the same, otherwise, communication can not be carried out. The higher the baud rate, the faster the communication speed.

Fd-01	Data Format	0: No verify (8-N-2) 1: Even verify (8-E-1) 2: Odd verify (8-O-1) 3: 8-N-1	0	○
-------	-------------	---	---	---

The host computer and the data format set by the inverter must be the same, otherwise, communication can not be carried out.

Fd-02	Local Address	0: is broadcast address 1~247: slave address	1	○
-------	---------------	---	---	---

When the machine address is set to 0, namely for the broadcast address, to achieve PC broadcast function.

The machine address is unique (except broadcast address), which is to achieve the basis of the PC and inverter point-to-point communications.

Fd-03	Response Delay	0ms~20ms	2ms	○
-------	----------------	----------	-----	---

Response delay: refers to the middle interval time of the inverter data reception ends to the host to send data. If the response delay is less than the system processing time, the response delay is based on the system processing time, if the response delay is longer than the system processing time, after the system processing the data, to delay the wait until the response delay time to send data to the host computer.

Fd-04	Communication Timeout Time	0.0 (disabled) 0.1s~60.0s	0.0s	○
-------	----------------------------	------------------------------	------	---

When the function code is set to 0.0 s, communication timeout time parameter is invalid.

When the function code set to valid values, if a communication and the interval time of the next communication beyond the communication timeout time, system will be reported to the communication failures (Err.18). Usually, it is set to invalid. If you set this parameter in a system with continuous communication, you can monitor the communication status.

Fd-05	Data Transfer Format Selection	0: Non standard MODBUS protocol 1: Standard MODBUS protocol	1	<input type="radio"/>
-------	--------------------------------	--	---	-----------------------

Fd-05=1: Selects the standard Modbus protocol.

Fd-05=0: When read command, the slave returns one byte more than the standard Modbus protocol, refer to "Communication Data Structure" of this protocol.

Fd-06	Communication Read Current Resolution	0: 0.01A 1: 0.1A	0	<input type="radio"/>
-------	---------------------------------------	---------------------	---	-----------------------

Used to determine the output unit of the current value when communication reads the output current.



Warranty Agreement

1. The warranty period of the product is 18 months from date of manufacturing. During the warranty period, if the product fails or is damaged under the condition of normal use by following the instructions, Vicruns will be responsible for free maintenance.
2. Within the warranty period, maintenance will be charged for the damages caused by the following reasons:
 - A. Improper use or repair/modification without prior permission;
 - B. Fire, flood, abnormal voltage, other disasters and secondary disaster;
 - C. Hardware damage caused by dropping or transportation after procurement;
 - D. Improper operation;
 - E. Trouble out of the equipment (for example, external device).
3. If there is any failure or damage to the product, please correctly fill out the Product Warranty Card in detail.
4. The maintenance fee is charged according to the latest Maintenance Price List of Vicruns.
5. The product Warranty Card is not re-issued. Please keep the card and present it to the maintenance personnel when asking for maintenance.
6. If there is any problem during the service, contact Vicruns's agent of Vicruns directly.
7. This agreement shall be interpreted by Hunan Vicruns Electric Technology Co., Ltd.

Vicruns Electric (Shenzhen) Co., Ltd.

25th Building, Xili Industrial Zone, Xiangguang Road, Nanshan District, Shenzhen, China

Tel: +86-755-26638560

Fax: +86-755-26639560

Hunan Vicruns Electric Technology Co., Ltd.

No.36, Shuangma No.6 Road, High-tech Zone, Xiangtan, Hunan, China

Tel: +86-731-55573999

Fax: +86-731-55571777

Email: oversea@vicruns.com

Webste: www.vicruns.com



Product Warranty Card

Customer Information	Address:	
	Company Name:	Contact Person:
	Postcode:	Tel of Email:
Product Information	Product Model:	
	Serial No:	
	Name of supplier who supplied you the unit:	
Failure Description (eg. Fault code)	Maintenance Personnel:	