

Preface

Thank you for purchasing VD100 Series Inverters!

VD100 series is a new generation product with high performance vector control platform. Adopting advanced vector control algorithm, it is widely used for asynchronous motor speed control. Through its integrated EMC design and with optimized PWM control technique to meet users' demand on environmental requirement such as low-noise in application places and low EMI. It has perfect anti-tripping control and adaptive ability to bad power grid, temperature, humidity and dust, in order to satisfy various sophisticated requirement under high precision drive applications. Thus to satisfy users expectation of higher reliability and stronger adaptability to environment of their equipment, achieving industry specialization and personalized motor drive and control system solution.

This manual expounds the related issues: installing and site wiring, setting parameters, operation, fault diagnosis and debugging and daily maintenance and correlation matters. Please read this manual and take good care of it to make sure you can install, use, maintain the inverter correctly, then play their superior performance.

Please let the user or maintainer keep good care of this handle book.

Unpacking and inspection:

Every inverter before shipping has been inspected under rigorous quality system.

Please confirm carefully when unpacking the packing carton:

- Check if any damage signs of the product and its package.
- Check if the model and inverter rated values on the nameplate are the same as stated on your order and user manual.
- The box contains the inverter, manufacturer certificate, user manual.

If the product is damaged during transportation, or there is any omission or damage, please contact our company or your local supplier immediately.

First time use:

The users who use this product for the first time shall read this manual carefully. For any doubt on certain functions and performances, please contact the technical support personnel of our company for help so as to use this product properly. With commitment to the constant improvement of the inverter products, our company may change the information provided without additional notice.

VD100 series inverter complies with the following international standards, and have passed the CE certification.

IEC/EN61800-5-1: 2003 "Safety Regulations on Commissionable Electric Drive System" IEC/EN 61800-3: 2004 Commissionable Electric Drive System:

Electromagnetic Compatibility Standard and Specific Testing Method for the Product (Comply with IEC/EN61000-2-1、2-2、3-2、3-3、4-2、4-3、4-4、4-5、4-6; EMC international and EU standard).

Contents

Chapter 1 Safety and Precautions.....	- 1 -
1.1 Safety Definition.....	- 1 -
1.2 Safety Precautions.....	- 1 -
Chapter 2 Product Information	- 4 -
2.1 Designation Rules.....	- 4 -
2.2 Nameplate	- 4 -
2.3 Inverter Series	- 5 -
2.4 Technical Specifications.....	- 5 -
2.5 Physical Appearance and Installation Dimensions	- 8 -
2.6 Braking Resistor Selection Table.....	- 10 -
2.7 Routine Repair and Maintenance	- 11 -
2.8 Instructions on Warranty	- 11 -
Chapter 3 Mechanical and Electric Installation	- 12 -
3.1 Installation Environment:.....	- 12 -
3.2 The Installation Direction and Space	- 12 -
3.3 Electrical Installation	- 12 -
3.4 Main Circuit Terminals	- 13 -
3.5 Control Circuit Terminal.....	- 14 -
Chapter 4 Operation and Display	- 17 -
4.1 Introduction of Operation and Display Interface	- 17 -
4.2 Motor Parameter Self-learning.....	- 20 -
4.3 Password Setting.....	- 20 -
4.4 Parameter Lock (authority lower than password).....	- 20 -
Chapter 5 Function Parameter Table	- 22 -
Chapter 6 Parameter Description	- 65 -
6.1 P00 Basic Function	- 65 -
6.3 P02 Motor 1 Parameters	- 77 -
6.4 P03 Motor 1 Vector Control Parameters Group	- 79 -
6.5 P04 Motor 1 V/F Control Parameters Group	- 85 -
6.6 P05 Input Terminals Function Parameter Group.....	- 89 -
6.7 P06 Output Terminal Function Parameter Group.....	- 102 -
6.8 P07 AIAO Correction Group.....	- 108 -
6.9 P08 Process PID Control Parameter Function.....	- 109 -
6.10 P09 Special Function Parameter Group	- 116 -
6.11 P10 Keyboard and Display.....	- 127 -
6.12 P11 MS Speed Function	- 133 -

6.13 P13 Protection Function Parameters Group	- 136 -
6.14 P14 Error Record Parameter Group	- 145 -
6.15 P15 Modbus Communication Parameter Group.....	- 147 -
6.16 P28 Status Monitoring Parameter Group	- 150 -
6.17 P29 User Parameter Group.....	- 152 -
Chapter 7 Communication Protocol.....	- 153 -
7.1 About Protocol	- 153 -
7.2 Application Methods.....	- 153 -
7.3 Bus Structure	- 153 -
7.4 Communication Protocol Introduction	- 153 -
7.5 Communication Frame Structure.....	- 154 -
7.6 Command Code and Communication Data Description	- 155 -
Chapter 8 Trouble Shooting	- 164 -
8.1 Error Alarm and Solution	- 164 -
8.2 Common Faults and Solutions	- 168 -

Chapter 1 Safety and Precautions

1.1 Safety Definition

During the installation, commissioning and maintenance of the system, please make sure to follow the safety and precautions of this chapter. In case of a result of illegal operations, caused any harm and losses is nothing to do with the manufacturer.

In this manual, safety precautions are divided into two types below:



DANGER

- Danger arising due to improper operations may cause severe hurt or even death.



WARNING

- Danger arising due to improper operations may cause moderate hurt or light hurt and equipment damage or property damage.

1.2 Safety Precautions

1.2.1 During Wiring



DANGER

- Operation shall be performed by electrical engineering professionals, otherwise there will be danger of electric shock!
- There shall be circuit breaker (which specification should match with inverter power capacity) between the inverter and power supply, otherwise, there might be fire!
- Make sure the wiring part is disconnected from power supply before connection. Hotline work is prohibited. If not it may be danger of electric shock!
- The earth terminal shall be earthed reliably, otherwise there may be danger of electric shock
- Do not connect input power onto output terminals U V W of inverter. Please confirm the terminal mark before connection, do not make wrong connection, if not it will damage inverter.
- Make sure the configured cables of main circuit conform to standard, if circuit conforms to EMC requirement and local safety standard. If not it might leave hiding accident or risk of danger!
- Please connect the breaker resistor with right specification to P+ PB terminal of inverter, if not it can damage inverter or even cause fire!
- Configure the control cable of inverter according to standard, the input and output control circuit of analog quantity and quick pulse should use shielded wire, and the wire single end should be reliable grounded.

1.2.2 Before Power-on

 **DANGER**

- Make sure if all the external fittings are connected correctly and wires are configured in accordance with its corresponding specification in this user manual. Otherwise accident may occur!
- Please confirm whether the power voltage class is consistent with the rated voltage of the inverter and whether the I/O cable connecting positions are correct, and check whether the external circuit is short circuited and whether the connecting line is firm, otherwise it may damage the inverter!

1.2.3 After Power-on

 **DANGER**

- Do not open the cover of the inverter upon power-on. Otherwise there will be danger of electric shock!
- Do not touch the inverter and its surrounding circuit with wet hand. Otherwise there will be danger of electric shock!
- Do not touch the inverter terminals (including control terminal), do not pull the connection wires, otherwise there will be danger of electric shock and damage of equipment!
- Do not enter into the manufacturer parameters or do any changes, otherwise it might result in malfunction or even damage to inverter.
- Before the inverter power-on with its loading, please make sure if the mechanical equipment is ready for working, and related staff is within safety zone, otherwise it might cause damage to equipment or human injury!
- If it is necessary to identify the motor parameters, please take good care while motor running, if not it might cause human injury or accident.

1.2.4 During the Operation

 **DANGER**

- Do not touch the fan or discharge resistor to sense the temperature. Otherwise, you may get hurt!
- Detection of signals during the operation shall only be conducted by qualified technician. Otherwise, personal injury or equipment damage may be caused!

 **WARNING**

- While inverter running, keep items from falling into inverter. Otherwise, it may damage the equipment!
- Please use terminal function or other control method of control circuit to start or stop inverter running, avoid adopting power-on mode to directly start inverter. It is prohibited to start or stop motor by connecting or disconnecting the contactor at the inverter output end.

1.2.5 During the Maintenance **DANGER**

- Do not repair and maintain the equipment if power is connected, otherwise there will be danger of electric shock!
- If the LED is still on light within the inverter body or on the control panel, it is prohibited to disassemble the body in order to avoid electric shock.
- The inverter shall be repaired and maintained only by the qualified person who has received professional training, otherwise, it may cause personal injury or equipment damage
- Carry out parameter setting after replacing the inverter, all the plug-ins must be plug and play when power outage For all the standard equipped or optional accessories, must be dismantled or mounted while the inverter power is disconnected.

Chapter 2 Product Information

2.1 Designation Rules

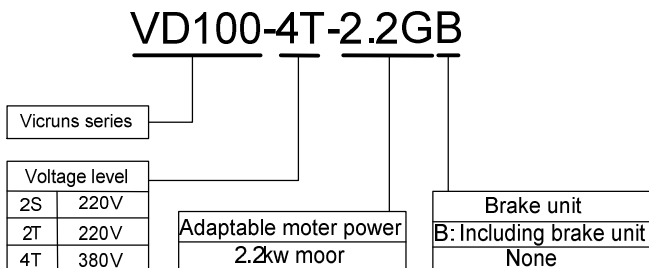



Fig.2-1 Designation Rules

2.2 Nameplate

Fig .2-2 Nameplate

 WARNING
<ul style="list-style-type: none"> ● The bar code on inverter nameplate is the only code to recognize its identity, so the bar code is the most important basis for the after sales service.

2.3 Inverter Series

Table 2-1 Model and Technical Data

Model	Power Capacity (kVA)	Rated Input Current (A)	Rated Output Current (A)	Adaptive Motor	
				Kw	HP
Single phase: 220V 50/60Hz					
VD100-2S-0.4GB	1.0	5.4	2.3	0.4	0.5
VD100-2S-0.7GB	1.5	8.2	4.0	0.75	1
VD100-2S-1.5GB	3.0	14.0	7.0	1.5	2
VD100-2S-2.2GB	4.0	23.0	9.6	2.2	3
Three Phase: 380V 50/60Hz					
VD100-4T-0.4GB	1.0	1.9	1.5	0.4	0.5
VD100-4T-0.7GB	1.5	3.4	2.5	0.75	1
VD100-4T-1.5GB	3.0	5.0	3.8	1.5	2
VD100-4T-2.2GB	4.0	5.8	5.1	2.2	3
VD100-4T-3.0GB	5.5	9.2	8.0	3.0	4
VD100-4T-4.0GB	6.5	11.0	9.6	4.0	5.5
VD100-4T-5.5GB	8.9	14.6	13.0	5.5	7.5

2.4 Technical Specifications

Table 2-2 Technical Specifications

Item		Specifications
Power Input	Rated Input Voltage	Grade of rated voltage is 220V or 380V: voltage continued fluctuation $\pm 10\%$, brief fluctuation:-15~+10%, voltage imbalance rated<3%, aberration rate meet IEC61800-2 requirements.
	Rated Input Current	Refer to Fig 2-1
	Rated Frequency	50Hz/60Hz fluctuation range $\pm 5\%$
Basic Function	Maximum Frequency	0Hz~650Hz

Carrier Frequency	1.0kHz~16.0kHz, can be adjusted automatically.
Input Frequency Resolution Ratio	0.01Hz
Control Mode	SVC control mode 0、SVC control mode 1、linear V/F control, parabola V/F control、multi-stage V/F、V/F separation
Startup Torque	0.25Hz/150%
Speed Adjustment range	1: 100
Speed Stabilization Precision	±0.5%
Overload Capacity	150% rated current 60s; 200% rated current 1s.
Torque Boost	Manual torque boost up 0.1% to 30.0%.
Acceleration/Deceleration Curve	Straight line or S curve acceleration / deceleration mode, 4 kinds of acceleration / deceleration time.
DC Braking	DC brake frequency: 0.00Hz to max frequency; brake time: 0.0s to 60.0s, brake action current: 0.0% to 100.0%.
Jog Control	Jog frequency range: 0.00Hz to 50.00Hz.
Multi-stage Running	A maximum of 16 segments speed running can be realized via the built-in reserved or control terminal.
Built-in PID	Can realize max 16-stage speed running via built-in reserved or control terminal.
Auto Voltage Regulation (AVR)	Can keep the output voltage constant automatically when the grid voltage changed.
Current Suppression	In V/F mode when load changes, it limits output current automatically, against over-current tripping, and achieve "digger" feature.

	Quick Current Suppression Function	Reduce over-current failure on the max extent, and protect normal operation of inverter.
	Dynamic Over-voltage Suppression	When operating frequency changes it can suppress energy feedback automatically, to prevent tripping due to bus overvoltage.
	Vibration Suppression	Optimize V/F oscillation arithmetic, realize V/F steady operation.
	Power dip ride through	It ensures that the AC drive continues to run for a short time when an instantaneous power failure or sudden voltage reduction occurs.
	Timing Control	Timing control function: setting time range 0.0min to 6500.0min.
Operation	Command Source	Operation panel reference, control terminal reference and serial communication port reference. These channels can be switched in various modes.
	Frequency Source	There are totally ten types of frequency sources, such as digital reference, analog voltage reference, analog current reference, pulse reference and serial port reference. These frequency sources can be switched in various modes.
	Auxiliary Frequency Source	There are 10 types of auxiliary frequency sources. It can implement flexible realization of auxiliary frequency fine tuning, synthesizer.
	Input Terminal	Five digital input terminals; one analog input terminals; support input 0V~10V voltage or 0//4mA to 20mA current.
	Output Terminal	One analog output terminal, support 0V~10V voltage output or 0/4~20mA current output; One electric digital output terminal; one relay output terminal.
Environment	Using Place	Indoor, and be free from direct sunlight, no dust, no corrosive gas or combustible gas or oil smoke, vapor, drip or salt etc.
	Altitude	Less than 2,000 meters (if higher than 2000M, then use de-rate).

	Ambient Temperature	-10°C to +40°C (de-rate when used in the ambient temperature of 40°C- 50°C Celsius).
	Humidity	Less than 95%RH, without condensing
	Vibration	Less than 5.9 m/s ² (0.6g).
	Storage Temperature	-20°C~+60°C
Protection Function		Motor short-circuit detection upon power-on, input/output phase loss protection, over current protection, over voltage protection, under voltage protection, over heat protection and overload protection.
Protection Grade		IP20
Cooling-down Method		Forced air cooling

2.5 Physical Appearance and Installation Dimensions

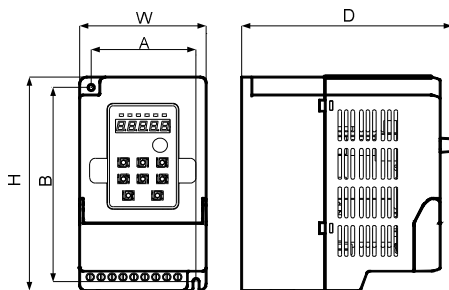

Fit models (wall mounted, single-phase three-phase 380V:0.4kW-2.2kW / 220V:0.4kW-1.5kW)

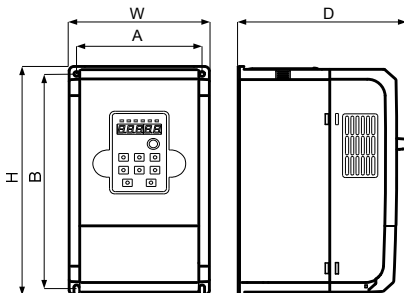

Fit models (wall mounted, single-phase three-phase 380V:3kW-5.5kW / 220V:2.2kW)

Figure 2.5-1 product outline and installation dimensions

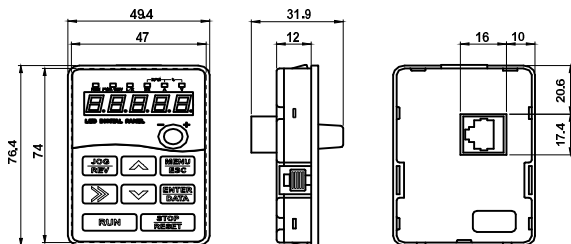

Keyboard size diagram

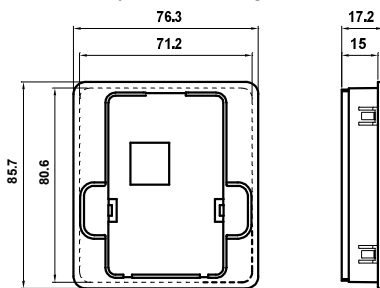

Pallet size diagram

Figure 2.5-2 External lead and tray of the shape size (mm)

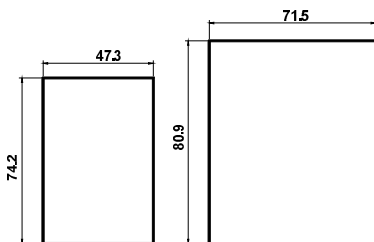

The keyboard does not add the tray (left) and the tray (right) when the aperture is installed

Table 2-3 Physical Dimensions and Mounting Hole Dimensions (mm)

Model	Mounting Hole mm		Physical Dimensions (mm)			Diameter of Mounting Hole (mm)	Weight
	A	B	H	W	D	d	kg
VD100-2S-0.4G	73	141	155	88	146.6	4.3	1.4
VD100-2S-0.7G							
VD100-2S-1.5G							
VD100-4T-0.4G							
VD100-4T-0.7G							
VD100-4T-1.5G							
VD100-4T-2.2G							
VD100-2S-2.2G	107.6	201	215	120	146	4.3	2.4
VD100-4T-3.0G							
VD100-4T-4.0G							
VD100-4T-5.5G							

2.6 Braking Resistor Selection Table

Table 2-4 Recommended Braking Resistor Selection Table

220V			380V		
Model	Resistance Value	Power	Model	Resistance Value	Power
VD100-2S-0.4G	360Ω	100W	VD100-4T-0.4G	750Ω	75W
VD100-2S-0.7G	200Ω	100W	VD100-4T-0.7G	650Ω	100W
VD100-2S-1.5G	100Ω	150W	VD100-4T-1.5G	330Ω	220W
VD100-2S-2.2G	65Ω	200W	VD100-4T-2.2G	220Ω	330W
			VD100-4T-3.0G	180Ω	450W
			VD100-4T-4.0G	120Ω	600W
			VD100-4T-5.5G	90Ω	750W

2.7 Routine Repair and Maintenance

The influence of the ambient temperature, humidity, dust and vibration will cause the aging of components in the inverter, that may bring potential problems or reduce the service life of inverter. Therefore, it is necessary to carry out routine and periodical maintenance on the inverter in order to keep inverter operation reliable and service longer time. The surrounding environment of inverter should be maintained every 3~6 months.

2.8 Instructions on Warranty



WARNING

- Free warranty only refers to the frequency converter.
- Please keep the machine outer package material, to facilitate future inverter relocation or repair and other logistics transportation.

Our company will provide 12-month warranty (starting from the date of production as indicated on the barcode) for the failure or damage under normal use conditions. If the equipment has been used for over 12 months, reasonable repair expenses will be charged.

2.8.1 In the warranty period, the following reasons lead to the failure of the inverter and damage, the user must bear part of the maintenance costs.

- ① The machine failure caused by the user does not use the user manual or beyond the standard specifications range use;
- ② The machine failure caused by the user repair and modify;
- ③ The machine failure caused by the user custody, maintenance improper.
- ④ Damage caused when the inverter is used for abnormal function;
- ⑤ The machine failure due to fires, floods, salt corrosion, corrosive gases, earthquake, storm, lightning, abnormal voltage or other non resistance caused by damage to the machine

2.8.2 Service Expense is Regulated Under Manufacturer's Unified Standard, if an Agreement Referred to Service Expenses is Existed in Advance, the Agreement Article is Applied Here.

Chapter 3 Mechanical and Electric Installation

3.1 Installation Environment:

The ambient temperature exerts great influences on the service life of the inverter and is not allowed to exceed the allowable temperature range (-10°C to 40°C). If temperature exceeds 40°C, a forced external cooling or de-rate usage is necessary.

The inverter shall be mounted on incombustible articles, with sufficient spaces nearby for heat sinking should be reserved;

The inverter shall be mounted in locations free from direct sunlight;

The inverter shall be mounted in locations free from humid and wet, relative humidity is < 95%;

The inverter shall be mounted in locations free from vibration, vibration < 5.9m/s² (0.6g);

The inverter shall be mounted in locations free from oil, dust, and metal powder;

The inverter shall be mounted in locations free from corrosive gas, explosive gas or combustible gas.

3.2 The Installation Direction and Space

Install the inverter vertically so that the heat may be expelled from the top. Installation location is indoor and with good ventilation.

3.3 Electrical Installation

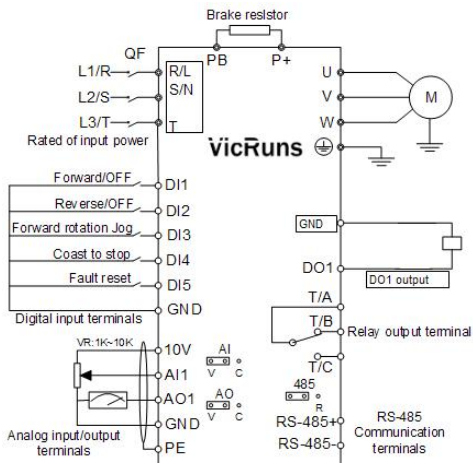

Fig.3-6 Schematic Diagram for Inverter Wiring

Precautions are as follows:

- 1) Terminal ⊙ refers to Main circuit terminal, terminal ○ refers to control circuit terminal;
- 2) If the last letter of model name is "B", it represents a built-in braking unit;
- 3) Braking resistor's selection is based on the user demand, refer to Fig 2-4;
- 4) Signal line must be separated routed from power lines, if control cable and power cable are crossed, let them cross by 90 degree angle. It is best to use shielded twisted pair cable for analogue signal, and to use shielded three-core cable (its specification should large a grade as the ordinary motor cables).

3.4 Main Circuit Terminals

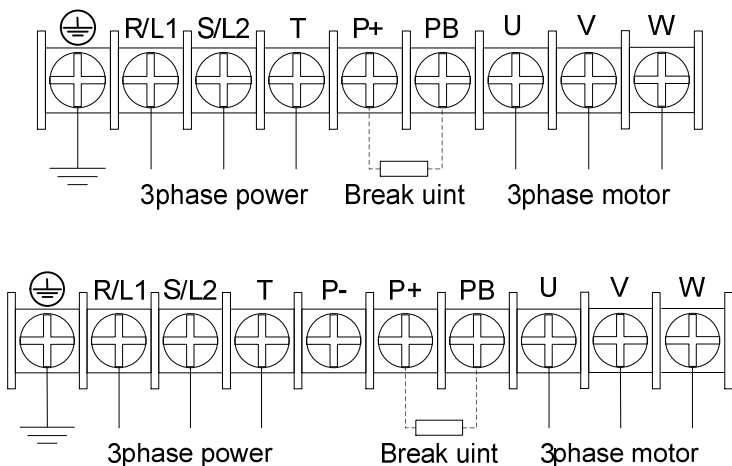

Fig 3.4-1 Connection diagram of main circuit for the inverter

3.4.1 Instructions of Main Circuit Terminals of Inverter:

Table 3-1 Instructions of main circuit terminals of inverter

Terminals Name	Description
R/L、S/N、T	AC power input terminal to connect power grid rated voltage
U、V、W	AC power output terminal to connect 3-phase alternator
P+、PB	Connecting terminal of

	brake resistor
⊕	Earth terminal

WARNING

VD100 series inverter power supply voltage has 220V, 380V as two voltage levels, please first confirm your power voltage available on hand is the same class as stated on inverter nameplate, otherwise do not connect with your power supply.

3.5 Control Circuit Terminal

3.5.1 Control Panel Layout Schematic Diagram

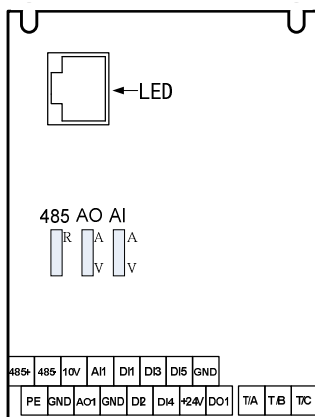

380V: 0.4kW-2.2kW

220V: 0.4kW-1.5kW

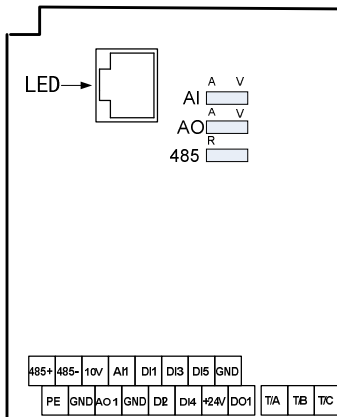

380V: 3kW-5.5kW

220V: 2.2kW

3.5.2 Function Description of Control Circuit Terminal

Table 3-2 Function description of control circuit terminal

Type	Terminal Symbol	Terminal Name	Function Description
Power Supply	10V-GND	External 10V Power Supply	<ol style="list-style-type: none"> 1. Provide +10V power supply for external unit 2. Generally used as power supply for external potentiometer and the resistance value is 1kΩ~5kΩ. 3. Max output current is 10mA.

	+24V-GND	External 24V Power Supply	<ol style="list-style-type: none"> 1. Provide +24V power supply only for digital output terminal. 2. Max output current is 20mA. 3. Do not use the +24V power for external power supply.
Communication	485+ 485-	RS485 Terminal	Standard RS-485 communication terminal, a shielded twisted pair cable should be used.
Analog Input	AI1-GND	Analog Input Terminal 1	Support 0V~10V voltage or 0/4mA~20mA current input, it is selected by the AI jumper, and default is 0V~10V voltage input.
Digital Input	DI1-GND	Digital input terminal 1	Multi-function digital input terminals, can set functions by P05.01~P05.05
	DI2-GND	Digital input terminal 2	
	DI3-GND	Digital input terminal 3	
	DI4-GND	Digital input terminal 4	
	DI5-GND	Digital input terminal 5	
Analog Output	AO1-GND	Analog Output terminal 1	Support 0V~10V voltage or 0/4mA~20mA current output, it is selected by the AO jumper, and default is 0V~10V voltage output.
Digital Output	DO1	Digital output terminal 1	<ol style="list-style-type: none"> 1. Opto-isolator, bipolar OC (open-collector) output. 2. Pull-up voltage range: 5V~24V (resistance range: 1kΩ~10kΩ). 3. Output current range: 2mA~20mA.
Relay Output	T/A-T/B	Relay T normally closed terminal	Contact driver capacity: AC250V, 3A; DC 30V, 5A;
	T/A-T/C	Relay T normally open terminal	
Shield Earth	PE	Shield cable ground terminal	<ol style="list-style-type: none"> 1. Used as shielding earth for control cable, when site environment interference is big or if control cable is too long, the terminal must be well grounded so to reduce EMI to conform to

			EMC regulated specifications. 2. Do not connect this terminal with power supply N line, otherwise it damages inverter.
--	--	--	---

Chapter 4 Operation and Display

4.1 Introduction of Operation and Display Interface

With the operation panel, it can perform such operations on the inverter as function parameter modification, inverter working status monitoring and inverter running control (start and stop).

Refer to Fig.4-1 for the physical appearance and functional zone of the operation panel:

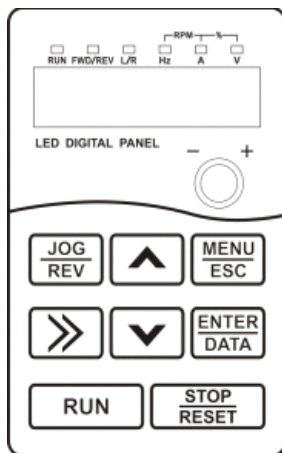





Fig.4.1-1 Operation Panel Diagram

4.1.1 Keypad Button Description

Buttons	Name	Function Description
	Programming Key	Enter or escape from the first level menu and remove the parameters quickly
	Enter Key	Enter the menu step-by-step Confirm parameters
	UP Key	Increase data or function code progressively
	DOWN Key	Decrease data or function code progressively

	Right-shift Key	Move right to select the displaying parameters circularly in stopping and running mode. Select the parameters modifying digit during the parameter modification
	Run Key	This key is used to operate on the inverter in key operation mode
	Stop/Reset Key	This key is used to stop in running state and it is limited by function code P10.00
	Quick Key	The function of this key is confirmed by function code P10.01

4.1.2 Description of LED Indicators

Name	Description
RUN	When it is off, it indicates the inverter is in stop status; when it is on, it indicates the rotation status; light flashes that inverter in automatic running.
FWD/REV	It is the LED indicator for forward/reverse rotation. When it is on, it indicates the inverter is in forward rotation status; when it is off, it indicates the inverter is in reverse rotation
L/R	When it's off, it indicates the keypad operation control status; when it's on, it indicates the terminal operation control status; when it's flicker, it indicates the remote operation control status
Hz	The unit of frequency (Hz)
A	The unit of current (A)
V	The unit of voltage (V)
RPM	The unit of rotation speed (RPM)
%	Unit: %
Hz, A, V	When all three lights on, it indicates the output/input terminal is in control status

4.1.3 Function Code Review and Modification Methods

The operation panel of the inverter adopts three-level menu structure to carry out operations such as parameter setting.

The three-level menu includes function parameter group (level 1 menu)→Function code (level 2 menu)→Function code setup value (level 3 menu). Refer to Fig.4.1-2 for the operation procedure.

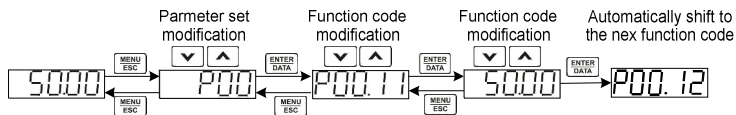

Fig.4.1-1 Level-3 menu operation process chart

When operating on level 3 menu, press MENU/ESC key or ENTER/DATA key to return to level 2 menu. The difference between them is described as follows:

Pressing ENTER/DATA KEY will save the setup parameter and return to the level 2 menu then automatically shift to the next function code. While pressing MENU/ESC key will directly return to level 2 menu without saving the parameter, and will return to the current function code.

In level 3 menu, when there is only one bit flashes then it can press ^ or v key to change its value. If there is 2 numbers need to be changed and press SHIFT key to the target bit and have this bit flashes then change value. If the parameter has no flashing bit, it indicates that the function code cannot be modified. It's possible reasons include:

- 1) The function code is an unchangeable parameter, such as actual detection parameter, run record parameter, etc; the parameter values whether in running or stopping conditions are normally on display.
- 2) The function code cannot be modified in running status, and inverter in running state, it can be modified only after the it stopped; the parameter values in the condition of running normally on display, in the condition of stop flashing.

4.1.4 State Display

The state display of operation panel is divided into stopping states parameter display, run state parameter display, function code parameter editing state display and fault alarm state display and so on.

1. Stop parameter display state

when the inverter is in the stopping state, the keyboard will display stopping parameters which is shown in figure. The 3bits on right indicator stand for the unit of the parameter, the 3bits on left indicator stand for current status. Such as, the run direction signal is reverse, then FWD/REV light on. Select check menu(also called user setup/user customize), only display the function code which is different from parameter set value and manufacturer value, press ^/v can browse function code which is different from all the parameter set value and manufacturer value, are convenient for the user to confirm which parameter are changed.

Press>> to display stop status parameter recycling. Function code P10.05 defines stop status parameter.

2. Displayed state of run parameters

After the inverter receives Enabled run commands, the inverter will enter into the run state and the keypad will display the run parameters. RUN is on while the FWD/REV is determined by the current run direction which is shown as flow.

Press>> to display run status parameter recycling. Function code P10.03 P10.04 defines run status parameter.

3. Function code editing status

In stop/run/error alarm status, press MENU/ESC can enter into edit status(if with password then input it, refer to P29.00). Edit status has 2 levels menu in sequence: function code group or function code----function code parameter, press ENTER/DATA enter into function parameter display status. In function parameter display status, press ENTER/DATA to save and jump to the next parameter, press MENU/ESC to quit to previous parameter.

4.2 Motor Parameter Self-learning

Select vector control mode, before inverter operation, must input the parameter from the nameplate of the motor, VD300 series inverter will match standard motor parameter according to this message. Vector control mode is highly dependent on motor parameter, so to acquire good control performance, it needs correct motor parameter.

Pay attention to below points during motor parameter self-learning.

- 1) Firstly to set run command source parameter P00.01=0 as control panel command channel, if motor self-learning required, then remove motor loading.
- 2) Input motor nameplate parameter correctly, including rate power/rate voltage/rate current/rate frequency/rate RPM, its corresponding function code P02.01~P02.05. If select motor 2, corresponding function code P20.01~P20.05
- 3) Via set function code P00.23 to select self-learning type, press ENTER/DATA to confirm displayed "-TUN-". Press RUN to start motor self-learning, and RUN light on, motor parameter self-learning is beginning. Once it is completed, LED will display "END".
- 4) After motor self-learning check P02.10 parameter, generally this value less than 60% of rate current P02.03, if not it is abnormal, need to do self-learning again, and confirm if motor is with empty loading.
- 5) When it is unavailable to get motor nameplate message, manufacturer set value can be used. It is only need to input motor power(motor 1 is P02.01, motor 2 is P20.01), no need motor self-learning.
- 6) If need to get the motor self-learning result recovered to manufacturer value, only need to revise motor rate power(motor 1 is P02.01, motor 2 is P20.01) then change back to required power, the parameter after self-learning can recover to manufacturer value automatically.
- 7) During self-learning process to press STOP/RESET to stop self-learning. Note the start/stop of self-learning can only be operated by keypad. After self-learning, the function code recover to 0.

4.3 Password Setting

The VD100 series inverter provides user password protection function. When P29.00 is set to non-zero value, it indicates the user password, and the password protection turns Enabled after exiting the function code editing status. When pressing MENU/ESC key again enter function code to view/edit state, "0.0.0.0.0." will be displayed, and common menu cannot be entered until user password is input correctly.

4.4 Parameter Lock (authority lower than password)

VD100 series inverter provide user parameter lock protection, when P00.21 is 1, lock is effective, if P00.21 is 2, just not allow to modify P29.01. Without setting user password, it can protect user parameter or prevent user get parameter initialized.

Chapter 5 Function Parameter Table

The symbols in the function table are described as follows:

○—It indicates that the parameter setup value can be modified when the inverter is in run state;

◎—It indicates that the parameter setup value cannot be modified when the inverter is in the run state;

●—It indicates that the numerical value of the parameter is the actually measured value, which cannot be modified;

☆—It indicates this parameter is “Factory default parameter” and can be set only by the manufacturer.

P00 Basic Function Group				
Function Code	Parameter Name	Setting Range	Factory Default Value	Property
P00.00	Motor Running Mode	0: V/F control mode 1: Sensor-less vector control mode 0 2: Sensor-less vector control mode 1	0	◎
P00.01	Running Command Source	0: Keyboard command source (L/R OFF) 1: Terminal command source (L/R ON) 2: Serial port command source (L/R flashes)	0	○
P00.02	Frequency Command Source A	0: Keypad potentiometer setting 1: Function code P00.11 setting	0	◎
P00.03	Frequency Command Source B	2: AI1 3: Reserved 4: Reserved 5: Reserved 6: Multi-stage speed running 7: Reserved 8: PID control setting 9: Communication setting	4	◎

P00.04	Frequency Source Superposition	0: K1*frequency instruction A 1: K2*frequency instruction B 2: K1*frequency instruction A+K2*frequency instruction B 3: K1*frequency instruction A-K2*frequency instruction B 4: MAX (K1*frequency instruction A, K2*frequency instruction B) 5: MIN (K1*frequency instruction A, K2*frequency instruction B) Remark: K1: P00.29 K2: P00.30	0	<input type="radio"/>
P00.05	Rang of Frequency Command Source B	0: Relative to maximum frequency 1: Relative to frequency source A	0	<input type="radio"/>
P00.06	Frequency output lower limit after superposition	-100%~100%(100% corresponding to P00.07)	0.0%	<input checked="" type="radio"/>
P00.07	Max Output Frequency	P00.09~650.00Hz	50.00Hz	<input checked="" type="radio"/>
P00.09	Running Frequency Upper Limit	P00.10~P00.07	50.00Hz	<input type="radio"/>
P00.10	Running Frequency Lower Limit	0.00Hz~P00.09	0.00Hz	<input type="radio"/>
P00.11	Keypad Set Frequency	0.00Hz~P00.07	50.00Hz	<input type="radio"/>
P00.12	Multi-stage Speed Command Source Section 0	0: Function code P11.00 1: Function code P00.11 2: AI1 3: Reserved 4: Reserved 5: Rapid pulse 6: PID control setup	0	<input checked="" type="radio"/>
P00.14	Acceleration Time 0	0.00s~3600.00s	Model dependent	<input type="radio"/>

P00.15	Deceleration Time 0	0.00s~3600.00s	Model dependent	○
P00.16	Acceleration/Deceleration Time Reference Frequency	0: Max output frequency 1: Set frequency	0	◎
P00.17	Rotation Direction	0: Same Direction 1: Reverse Direction	0	○
P00.18	Reverse Control	0: Allow reverse 1: Forbid reverse	0	○
P00.19	Carrier Frequency Setting	1.0kHz~16.0kHz	Model dependent	○
P00.21	Parameter Lockup Selection	0: Parameter lockup disabled 1: Parameter lockup enabled and other parameters cannot be changed except the current one 2: Not permitted to operate parameter initializing function code	0	○
P00.23	Motor Parameter Self-learning	0: No operation 1: Dynamic self-learning 2: Static self-learning 3: Rapid static self-learning	0	◎
P00.24	AVR Function Selection	0: Disabled 1: Enabled	1	○
P00.25	Over Modulation Selection	0x00~0x11 Unit's digit of LED: 0: Over modulation disabled 1: Over modulation enabled Ten's digit of LED: 0: Mild over modulation 1: Depth over modulation	0X01	◎
P00.28	Load Type Selection(Only Enabled For V/F)	Unit's digit of LED: motor 1 load type selection 0: Non-inertia load 1: Inertia load Ten's digit of LED: motor 2 load	0x00	◎

		type selection 0: Non-inertia load 1: Inertia load		
P00.29	K1 Coefficient	0.000~20.000	1.000	○
P00.30	K2 Coefficient	0.000~20.000	1.000	○
P01 Start/Stop Control Parameter Group				
Function Code	Parameter Name	Setting Range	Factory Default Value	Property
P01.00	Start Running Mode	0: Directly start 1: DC braking restart	0	◎
P01.01	Directly Start Initial Frequency	0.00Hz~10.00Hz	0.50Hz	◎
P01.02	Initial Frequency Holding Time	0.0s~60.0s	0.0s	◎
P01.03	DC Braking Current Before Start	0.0%~100.0% (100% corresponding inverter rated current)	0.0%	◎
P01.04	DC Braking Time Before Start	0.00s~60.00s	0.00s	◎
P01.05	Stop Mode Selection	0: Deceleration to stop 1: Coast to stop	0	○
P01.06	Initial Frequency of Stop DC Braking	0.00Hz ~P00.07	0.00Hz	○
P01.07	Waiting Time of Stop DC Braking	0.00s~60.00s	0.001s	○
P01.08	Stop DC Braking Current	0.0%~100.0% (100% corresponding inverter rated current)	0.0%	○
P01.09	Stop DC Braking Time	0.00s~60.00s	0.00s	○
P01.10	Excitation Braking Coefficient	0: Disabled 100~150: The greater the coefficient, the greater the braking intensity	0	○
P01.11	Short-circuit Braking	0.0%~150% (100%	0.0%	○

	Current	corresponding inverter rate current)		
P01.12	Startup Short-circuit Braking Holding Time	0.00s~60.00s	0.00s	○
P01.13	Stop Short-circuit Braking Holding Time	0.00s~60.00s	0.00s	○
P01.14	Switchover Mode between FWD/REV Rotation	0: Switchover with zero frequency 1: Switchover with over starting frequency 2: Switchover at stop speed reach and delay	0	◎
P01.15	FWD/REV Rotation Dead-zone Time	0.0s~3600.0s	0.0s	○
P01.16	Stop Speed	0.00Hz~100.00Hz	0.50Hz	◎
P01.17	Detection Mode of Stop Speed	0: Detect according to speed set value(no stop delay) 1: Detect according to speed feedback(only enabled for vector control)	0	◎
P01.18	Detection Time of Feedback Speed	0.00s~100.00 s (only enable to P01.17=1)	0.50s	◎
P01.19	Delay Time of Delay Time	0.0s~100.0s	0.0s	○
P01.20	Running Frequency Lower than Frequency Lower Limit Action	0: Running with frequency lower limit 1: Stop 2: Dormant standby	0	◎
P01.21	Dormant Recover Delay Time	0.0s~3600.0s(corresponding P01.20=2)	0.0s	○
P01.22	Power-on Terminal Running Protection Selection	0: Terminal operation command is disabled when power on 1: Terminal operation command is enabled when power on	0	○
P01.23	Restart Selection Upon Power Failure	0: Disabled restart 1: Allow restart	0	○

P01.24	Waiting Time of Restart Upon Power Failure	0.0s~3600.0s (correspond P01.23=1 effective)	1.0s	<input type="radio"/>
P01.25	Start Delay Time	0.0s~60.0s	0.0s	<input checked="" type="radio"/>
P01.26	Acceleration/Deceleration Mode Selection	0: Straight-line type	0	<input checked="" type="radio"/>
P02 Motor Parameters Group				
Function Code	Parameter Name	Setting Range	Factory Default Value	Property
P02.00	Motor Type Selection	0: Asynchronous motor	0	<input checked="" type="radio"/>
P02.01	Asynchronous Motor Rated Power	0.4kW~7.5kW	Model dependent	<input checked="" type="radio"/>
P02.02	Asynchronous Motor Rated Voltage	0V~400V	Model dependent	<input checked="" type="radio"/>
P02.03	Asynchronous Motor Rated Current	0.0A~50.0A	Model dependent	<input checked="" type="radio"/>
P02.04	Asynchronous Motor Rated Frequency	0.00Hz~650.00Hz	Model dependent	<input checked="" type="radio"/>
P02.05	Asynchronous Motor Rated RPM	0RPM~65535RPM	Model dependent	<input checked="" type="radio"/>
P02.06	Asynchronous Motor Stator Resistance	0.000Ω~65.535Ω	Model dependent	<input type="radio"/>
P02.07	Asynchronous Motor Rotor Resistance	0.000Ω~65.535Ω	Model dependent	<input type="radio"/>
P02.08	Asynchronous Motor Rotor and Stator Leakage Inductive Reactance	0.0mH~6553.5mH	Model dependent	<input type="radio"/>
P02.09	Asynchronous Motor Rotor and Stator Mutual Inductive Reactance	0.0mH~6553.5mH	Model dependent	<input type="radio"/>

P02.10	Asynchronous Motor No-load Current	0.0A~P02.03 (motor rated current)		Model dependent	○
P03 Vector Control Parameters Group					
Function Code	Parameter Name	Setting Range		Factory Default Value	Property
P03.00	Speed/Torque Control Selection	0: Speed control 1: Torque control		0	◎
P03.01	Speed Loop Proportion Gain 1	0~200.0	Vector 0: 10.0	○	
			Vector 1: 20.0		
P03.02	Speed Loop Integral Time 1	0.000s~10.000s		0.200s	○
P03.03	Switchover Low Point Frequency	0.00Hz~P03.06		5.00Hz	○
P03.04	Speed Loop Proportional Gain 2	0~200.0	Vector 0: 10.0	○	
			Vector 1: 20.0		
P03.05	Speed Loop Integral Time 2	0.000s~10.000s		0.100s	○
P03.06	Switchover High Point Frequency	P03.03~P00.07		10.00Hz	○
P03.07	Speed Loop Output Filter	0~8(corresponding 0~2^8/10ms)		0	○
P03.08	Vector Control Slip Compensation Coefficient (Motoring Condition)	50%~200%		100%	○
P03.09	Vector Control Slip Compensation Coefficient (Generating Condition)	50%~200%		100%	○
P03.10	Current Loop Proportion Coefficient P	0~60000		1000	○
P03.11	Current Loop Integral Coefficient I	0~60000		1000	○

P03.12	Torque Setting Mode Selection	0: Function code P03.13 1: AI1 (100% corresponding P03.13) 2: Reserved 3: Reserved 4: High speed Pulse input (Optional) 5: Communication setting	0	<input type="radio"/>
P03.13	Keypad Setting Torque	-300.0%~300.0% (rated motor current)	100.0%	<input type="radio"/>
P03.14	Torque Setting Filter Time	0.000s~10.000s	0.100s	<input type="radio"/>
P03.15	Source Setting of Frequency Upper Limit of Forward in Torque Control	0: Function code P03.17 1: AI1 (100% relate to max output frequency) 2: Reserve 3: Reserve 4: High speed Pulse input (Optional) 5: Communication setting	0	<input type="radio"/>
P03.16	Source Setting of Frequency Upper Limit of Reverse in Torque Control	0: Function code P03.18 1: AI1 (100% relate to max output frequency) 2: Reserve 3: Reserve 4: High speed Pulse input (Optional) 5: Communication setting	0	<input type="radio"/>
P03.17	Frequency Upper Limit Keypad Setting of Forward in Torque Control	0.00Hz~P00.07	50.00Hz	<input type="radio"/>
P03.18	Frequency Upper Limit Keypad setting of Reverse in Torque Control	0.00Hz~P00.07	50.00Hz	<input type="radio"/>

P03.19	Electric Torque Upper Limit Source Setting	0: Function code P03.21 1: AI1 (100% relate to 3 times of motor current) 2: Reserved 3: Reserved 4: High speed Pulse input (Optional) 5: Communication setting	0	<input type="radio"/>
P03.20	Braking Torque Upper Limit Source Setting	0: Function code P03.22 1: AI1 (100% relate to 3 times of motor current) 2: Reserved 3: Reserved 4: High speed Pulse input (Optional) 5: Communication setting	0	<input type="radio"/>
P03.21	Electric Torque Upper Limit Keypad Setting	0.0%~300.0% (rated motor current)	180.0%	<input type="radio"/>
P03.22	Braking Torque Upper Limit Keypad Setting	0.0%~300.0% (rated motor current)	180.0%	<input type="radio"/>
P03.23	Max Voltage Limit	0.0%~120.0%	100.0%	<input checked="" type="radio"/>
P03.24	Pre-excitation Time	0.000s~10.000s	0.300s	<input type="radio"/>
P03.25	Weak Magnetic Coefficient in Constant Work Area	0.1~2.0	0.3	<input type="radio"/>
P03.26	Min Weak Magnetic Point in Constant Work Area	10%~100%	20%	<input type="radio"/>
P03.27	Vector Control Weak Magnetic Proportion Gain	0~4000	1200	<input type="radio"/>
P03.28	Low Speed Torque Compensation Coefficient	0.0%~50.0%	0.0%	<input type="radio"/>

P03.29	High Speed Torque Compensation Coefficient	0.0%~50.0%	0.0%	<input type="radio"/>
P03.30	Low Frequency Torque Compensation Cutoff Frequency	0.00Hz~50.00Hz	5.00Hz	<input type="radio"/>
P03.31	High Frequency Torque Compensation Cutoff Frequency	0.00Hz~100.00Hz	50.00Hz	<input type="radio"/>
P03.35	Torque Control Stator Resistance Compensation Selection	0: Disabled 1: Enabled	0	<input type="radio"/>
P04 Motor V/F Control Parameter Group				
Function Code	Parameter Name	Setting Range	Factory Default Value	Property
P04.00	Motor V/F Curve Setting	0: Straight line V/F curve 1: Multi-stage V/F curve 2: 1.3#power low torque V/F curve 3: 1.7#power low torque V/F curve 4: 2.0#power low torque V/F curve 5: V/F complete separation 6: V/F half separation	0	<input checked="" type="radio"/>
P04.02	Motor V/F Frequency Point 1	0.00Hz~P04.04	0.00Hz	<input type="radio"/>
P04.03	Motor V/F Voltage Point 1	0.0%~110.0% (rated motor voltage)	0.0%	<input type="radio"/>
P04.04	Motor V/F Frequency Point 2	P04.02~ P04.06	0.00Hz	<input type="radio"/>
P04.05	Motor V/F Voltage Point2	0.0%~110.0% (rated motor voltage)	0.0%	<input type="radio"/>
P04.06	Motor V/F Frequency Point 3	P04.04~ P00.07	0.00Hz	<input type="radio"/>

P04.07	Motor V/F Voltage Point 3	0.0%~110.0% (rated motor voltage)	0.0%	<input type="radio"/>
P04.08	Motor V/F Slip Compensation Gain	0.0%~200.0%	100.0%	<input type="radio"/>
P04.09	V/F Torque Boost	0.0%: (Automatic) 0.1%~10.0%	0.0%	<input type="radio"/>
P04.10	Cutoff Frequency of Motor Torque Boost	0.0%~50.0% (rated motor frequency)	20.0%	<input type="radio"/>
P04.11	Low Frequency Suppression Oscillation Factor of Motor	0~100	10	<input type="radio"/>
P04.12	High Frequency Suppression Oscillation Factor of Motor	0~100	10	<input type="radio"/>
P04.13	Suppression Oscillation Cut-off Point of Motor	0.00Hz~P00.07	30.00Hz	<input type="radio"/>
P04.14	Motor Voltage Setting Source Selection	0: Function code P04.15 setting 1: AI1 set voltage 2: Reserved 3: Reserved 4: Reserved 5: PID set voltage 6: Communication setting	0	<input checked="" type="radio"/>
P04.15	Motor Keypad Setting Voltage Value	0.0%~100.0%	100.0%	<input type="radio"/>
P04.16	Motor Voltage Increasing Time	0.0s~3600.0s	5.0s	<input type="radio"/>
P04.17	Motor Voltage Decreasing Time	0.0s~3600.0s	5.0s	<input type="radio"/>
P04.18	Motor Maximum Output Voltage	P04.19~100.0% (rated motor voltage)	100.0%	<input checked="" type="radio"/>
P04.19	Motor Minimum Output Voltage	0.0%~ P04.18 (rated motor voltage)	0.0%	<input checked="" type="radio"/>

P04.20	Motor V/F Control Weak Magnetic Coefficient	1.00~1.30	1.00	○
P04.21	Energy Saving Running Selection of Motor	0: Disabled 1: Enabled	0	◎
P05 Input terminal Parameters Group				
Function Code	Parameter Name	Setting Range	Factory Default Value	Property
P05.00	Terminal Control Running Mode	0: Two-line mode 1 1: Two-line mode 2 2: Three-line mode 1 3: Three-line mode 2 4: Alternate control 5: Back and forth control	0	◎
P05.01	DI1 Input Terminal Function Selection	0: No function 1: Forward running 2: Reverse running 3: Three-line mode run control 4: Forward Jog 5: Reverse Jog 6: Coast to stop	1	◎
P05.02	DI2 Input Terminal Function Selection	7: Run pause 8: Fault reset 9: External fault input 10: Frequency setting increase (UP) 11: Frequency setting decrease (DOWN)	2	◎
P05.03	DI3 Input Terminal Function Selection	12: Frequency UP/DOWN setting clear 13: Frequency UP/DOWN setting clear temporary 14: Acceleration/deceleration time selection 1	4	◎

P05.04	DI4 Input Terminal Function Selection	15: Acceleration/deceleration time selection 1 16: MS speed terminal 1 17: MS speed terminal 2 18: MS speed terminal 3 19: MS speed terminal 4	6	◎
P05.05	HDI1 Input Terminal Function Selection	20: Multi-step speed pause 21: Immediate DC braking 22: Deceleration DC braking 23: External stop 24: Emergency stop 25: PID control pause 26: Reverse PID action direction 27: PID parameter switchover 28: Pre-excitation command 29: Torque control disabled 30: Acceleration/down disabled 31: Switchover between set A and set B 32: Switchover between combined set and set A 33: Switchover between combined set and set B 34: Simple PLC stop reset 35: Simple PLC pause 36: Counter trigger 37: Counter reset 38: Length trigger 39: Length reset 40: Command switchover to keypad 41: Command switchover to terminal 42: Command switchover to communication 43: Power consumption clear 44: Power consumption holding 45: Swing frequency pause (stop at present frequency)	8	◎

		46: Swing frequency reset (back to center frequency) 47: Motor switchover 48: Clear the current running time 49: User-defined failure input 1 50~63: Reserved		
P05.11	Input Terminal Polarity Selection	0x00~0x1F	0x00	◎
P05.12	Digital Input Filtering Time	0.000s~1.000s	0.010s	○
P05.18	AI1 Input Type Selection	0: Voltage input type 1: Current input type	0	○
P05.19	Lower Limit of AI1 Voltage	-10.00V~P05.21	0.00V	○
P05.20	Corresponding Setting of AI1 Voltage Lower Limit	-100.0%~100.0%	0.0%	○
P05.21	Upper Limit of AI1 Voltage	P05.19~10.00V	10.00V	○

P05.22	Corresponding Setting of AI1 Voltage Upper Limit	-100.0%~100.0%	100.0%	○
P05.23	Lower Limit of AI1 Current	-20.00mA~P05.25	0.00mA	○
P05.24	Corresponding Setting of AI1 Current Lower Limit	-100.0%~100.0%	0.0%	○
P05.25	Upper Limit of AI1 Current	P05.23~20.00mA	20.00mA	○
P05.26	Corresponding Setting of AI1 Current Upper Limit	-100.0%~100.0%	100.0%	○
P05.27	AI1 Input Filter Time	0.000s~10.000s	0.100s	○
P05.39	Minimum Frequency of High-speed Pulse Input HDI1	0.00kHz~P05.41	0.00kHz	○
P05.40	Corresponding Setting of Minimum Frequency of High-Speed Pulse Input HDI1	-100.0%~100.0%	0.0%	○
P05.41	Maximum Frequency of High-Speed Pulse Input HDI 1	P05.39~100.00kHz	50.00kHz	○
P05.42	Corresponding Setting of Maximum Frequency of High-Speed Pulse Input HDI1	-100.0%~100.0%	100.0%	○
P05.43	HS (Pulse) Input HDI1 Filter Time	0.000s~10.000s	0.100s	○
P05.44	DI1 Terminal Close Delay Time	0.000s~60.000s	0.000s	○
P05.45	DI1 Terminal Disconnect Delay Time	0.000s~60.000s	0.000s	○

P05.46	DI2 Terminal Close Delay Time	0.000s~60.000s	0.000s	<input type="radio"/>
P05.47	DI2 Terminal Open Delay Time	0.000s~60.000s	0.000s	<input type="radio"/>
P05.48	DI3 Terminal Close Delay Time	0.000s~60.000s	0.000s	<input type="radio"/>
P05.49	DI3 Terminal Open Delay Time	0.000s~60.000s	0.000s	<input type="radio"/>
P05.50	DI4 Terminal Close Delay Time	0.000s~60.000s	0.000s	<input type="radio"/>
P05.51	DI4 Terminal Open Delay Time	0.000s~60.000s	0.000s	<input type="radio"/>
P05.52	HDI1 Terminals Close Delay Time	0.0s~6000.0s	0.0s	<input type="radio"/>
P05.53	HDI1 Terminals Open Delay Time	0.0s~6000.0s	0.0s	<input type="radio"/>
P05.62	Virtual Input Terminal Setting Selection	0: Disabled 1: Communication setting	0	<input type="radio"/>
P05.63	Travel Switch Lock Time	0.0s~60.0s	1.0s	<input type="radio"/>
P06 Output Terminal Parameters Group				
Function Code	Parameter Name	Setting Range	Factory Default Value	Property
P06.00	HDO1 Terminals Function Selection	0: HS Pulse output (option) 1: Switch signal output	1	<input type="radio"/>
P06.02	Output Terminal Polarity Selection	0x00~0x05	0x00	<input type="radio"/>
P06.03	HDO1 Output Terminal Function Selection	0: Disabled 1: Inverter in running 2: Forward running 3: Reverse running	0	<input type="radio"/>

P06.05	Relay T Output Function Selection	4: Jog running 5: Inverter Fault 6: Pre-excitation 7: Ready for run 8: Overload pre-warning 9: Off load pre-warning 10: Frequency level detection FDT1 output 11: Frequency level detection FDT2 output 12: Zero speed running 13: Frequency reached 14: Frequency upper limit reached 15: Frequency lower limit reached 16: Set count value reached 17: Designated count value reached 18: Reserved 19: Reserved 20: External equipment fault enabled 21: Accumulative running time reached 22: Accumulative power-on time reached 23: Current running time reached 24: Current power-on time reached 25: Any frequency reached 26: Any current reached 27: Current limit exceeded 28: Communication virtual terminal output 29: Reserved 30: Stop command output 31: Run (non-jog run) 32: Length reached	0	○
--------	--------------------------------------	--	---	---

P06.08	AO1 Analog Output Selection	<p>0: Running frequency (100.0% Corresponding the maximum output frequency)</p> <p>1: Set frequency (100.0% Corresponding the maximum output frequency)</p> <p>2: Output current 1 (100.0% Corresponding 2 times of rated motor current)</p> <p>3: Output voltage1 (100.0% Corresponding 1.5 times of rated inverter voltage)</p> <p>4: Motor rotational speed (100.0% Corresponding 2 times of rated motor speed)</p> <p>5: Output power (100.0% Corresponding 2 times of rated motor power)</p> <p>6: Reserved</p> <p>7: Analog AI1 input value</p> <p>8: Reserved</p> <p>9: Reserved</p> <p>10: Reserved</p> <p>11: Count value</p> <p>12: Output torque (100.0% corresponding 2 times of motor rated torque)</p> <p>13: Output current 2 (0.0A~1000.0A)</p> <p>14: Output voltage 2 (0.0V~1000.0V)</p> <p>15: Slope set frequency (100.0% corresponding max output frequency)</p> <p>16: Communication set value 1</p> <p>17: Communication set value 2</p> <p>18~25: Reserved</p>	0	○
P06.11	AO1 Output Voltage Lower Limit	0.00V~P06.13	0.00V	○

P06.12	Corresponding Setting Value of AO1 Voltage Output Lower Limit	0.0%~100.0%	0.0%	○
P06.13	AO1 Output Voltage Upper Limit	P06.11~10.00V	10.00V	○
P06.14	Corresponding Setting Value of AO1 Output Voltage Upper Limit	0.0%~100.0%	100.0%	○
P06.15	AO1 Output Filter Time	0.000s~10.000s	0.000s	○
P06.21	HDO1 Output Voltage (Current) Lower Limit	0.0%~P06.23	0.0%	○
P06.22	Lower Limit Corresponding HDO1 Output	0.00kHz~100.00kHz	0.0kHz	○
P06.23	HDO1 Output Upper Limit	P06.21~100.0%	100.0%	○
P06.24	Upper Limit Corresponding HDO1 Output	0.00kHz~100.00kHz	50.00kHz	○
P06.25	HDO1 Output Filter Time	0.000s~10.000s	0.000s	○
P06.26	DO1 Terminals Closed Delay	0.0s~6000.0s	0.0s	○
P06.27	DO1 Terminals Open Delay	0.0s~6000.0s	0.0s	○
P06.30	HDO1 Terminals Close Delay	0.0s~60.000s	0.000s	○
P06.31	HDO2 Terminals Open Delay	0.0s~60.000s	0.000s	○
P07 AIAO Correction Group				
Function Code	Parameter Name	Setting Range	Factory Default Value	Property

P07.00	AI1 Measured Voltage 1	0.500V~4.000V	Factory Correction	<input type="radio"/>
P07.01	AI1 Displayed Voltage 1	0.500V~4.000V	Factory Correction	<input type="radio"/>
P07.02	AI1 Measured Voltage 2	6.000V~9.999V	Factory Correction	<input type="radio"/>
P07.03	AI1 Displayed Voltage 2	6.000V~9.999V	Factory Correction	<input type="radio"/>
P07.12	AO1 Target Voltage 1	0.500V~4.000V	Factory Correction	<input type="radio"/>
P07.13	AO1 Measured Voltage 1	0.500V~4.000V	Factory Correction	<input type="radio"/>
P07.14	AO1 Target Voltage 2	6.000V~9.999V	Factory Correction	<input type="radio"/>
P07.15	AO1 Measured Voltage 2	6.000V~9.999V	Factory Correction	<input type="radio"/>
P08 Process PID Control Parameters Group				
Function Code	Parameter Name	Setting Range	Factory Default Value	Property
P08.00	PID Command Source	0: Function code P08.01 1: AI1 2: Reserved 3: Reserved 4: High speed pulse input (Optional) 5: MS speed command 6: Communication setting 7: Keypad potentiometer	0	<input type="radio"/>
P08.01	PID Command Set Value	0.0%~100.0%	50.0%	<input type="radio"/>
P08.02	PID Command UP/DOWN Time	0.00s~100.00s	0.00s	<input type="radio"/>

P08.03	PID Feedback Source	0: AI1 1: Reserved 2: Reserved 3: Reserved 4: Reserved 5: Reserved 6: Reserved 7: HS Pulse input setting (optional) 8: Communication control	0	<input type="radio"/>
P08.04	PID Output Feature Selection	0: PID output is positive feature 1: PID output is negative feature	0	<input type="radio"/>
P08.05	PID Feedback Display Coefficient	0.00~655.35	1.00	<input type="radio"/>
P08.06	Proportional Gain 1	0.0~100.0	1.00	<input type="radio"/>
P08.07	Integral Time 1	0.00: Disabled integral 0.01s~10.00s	0.10	<input type="radio"/>
P08.08	Differential Time 1	0.00s~10.00s	0.00s	<input type="radio"/>
P08.09	Proportional Gain 2	0.0~100.0	1.00	<input type="radio"/>
P08.10	Integral Time 2	0.00: Disabled integral 0.01s~10.00s	0.10	<input type="radio"/>
P08.11	Differential Time 2	0.00s~10.00s	0.00	<input type="radio"/>
P08.12	PID Parameter Switchover Condition	0: No switch (only use PID parameter 1) 1: DI terminal 2: Auto switch according to deviation	0	<input type="radio"/>
P08.13	PID Parameter Switchover Deviation 1	0.0%~100.0%	20.0%	<input type="radio"/>
P08.14	PID Parameter Switchover Deviation 2	0.0%~100.0%	80.0%	<input type="radio"/>

P08.15	PID Deviation Limit	0.0%~100.0%	0.0%	<input type="radio"/>
P08.16	PID Preset Output Mode	0: No preset output mode 1: Output according to holding time 2: Output when PID feedback< switchover threshold 3: Output when PID feedback> switchover threshold	0	<input checked="" type="radio"/>
P08.17	PID Preset Output Value	0.0%~100.0% (as frequency command relative to max output frequency P00.07)	10.0%	<input type="radio"/>
P08.18	PID Preset Output Value Holding Time	0.00s~600.00s	0.50s	<input type="radio"/>
P08.19	PID Preset Output Switchover Threshold	0.0%~100.0%	50.0%	<input type="radio"/>
P08.20	Feedback Wire-break Detection Value	0.0%: No detection 0.1%~100.0%	0.0%	<input type="radio"/>
P08.21	Feedback Wire-break Detection Time	0.0s~20.0s	0.0s	<input type="radio"/>
P08.22	Feedback Over-limit Detect Value	0.0%: No detection 0.1%~100.0%	0.0%	<input type="radio"/>
P08.23	Feedback Over-limit Detection Time	0.0s~20.0s	0.0s	<input type="radio"/>
P08.24	PID Dormant Threshold	P08.25~100.0% 100.0%: cancel sleep function	100.0%	<input type="radio"/>
P08.25	PID Wakeup Threshold	0.0%~ P08.24	0.0%	<input type="radio"/>
P08.26	PID Dormant Waiting Time	0.0s~6000.0s	1.0s	<input type="radio"/>
P08.27	PID Wakeup Waiting Time	0.0s~6000.0s	0.5s	<input type="radio"/>
P08.28	PID Calculation Mode	0: Stop with no calculation 1: Stop with calculation	0	<input type="radio"/>

P08.29	PID Output Positive Max Value	0.0%~100.0%	100.0%	<input type="radio"/>
P08.30	PID Output Reverse Max Value	0.0%~100.0%	0.0%	<input type="radio"/>
P08.33	PID Output Positive Maximum Variation	0.0%~100.0%	2.0%	<input type="radio"/>
P08.34	PID Output Reverse Maximum Variation	0.0%~100.0%	2.0%	<input type="radio"/>
P08.36	PID Adjust Selection	0: Continue integration arriving upper and lower limit 1: Stop integration arriving upper and lower limits	1	<input type="radio"/>
P08.37	Lower Limit Frequency of Feedback Break Line Detection	0.00Hz~50.00Hz	10.00Hz	<input type="radio"/>
P09 Special Function Parameters Group				
Function Code	Parameter Name	Setting Range	Factory Default Value	Property
P09.00	Jog Running Frequency	0.00Hz~P00.07	5.00Hz	<input type="radio"/>
P09.01	Jog Running Acceleration Time	0.0s~3600.0s	Model dependent	<input type="radio"/>
P09.02	Jog Running Deceleration Time	0.0s~3600.0s	Model dependent	<input type="radio"/>
P09.03	Acceleration Time 1	0.0s~3600.0s	Model dependent	<input type="radio"/>
P09.04	Deceleration Time 1	0.0s~3600.0s	Model dependent	<input type="radio"/>
P09.05	Acceleration Time 2	0.0s~3600.0s	Model dependent	<input type="radio"/>
P09.06	Deceleration Time 2	0.0s~3600.0s	Model dependent	<input type="radio"/>
P09.07	Acceleration Time 3	0.0s~3600.0s	Model dependent	<input type="radio"/>
P09.08	Deceleration Time 3	0.0s~3600.0s	Model	<input type="radio"/>

			dependent	
P09.09	Set Frequency Reaching Detection Amplitude	0.00Hz~P00.07	0.00Hz	○
P09.10	Frequency Detection Value 1 (FDT1)	0.00Hz~P00.07	50.00Hz	○
P09.11	Frequency Detection 1 Hysteresis Value	0.0%~100.0% (relative to FDT1)	5.0%	○
P09.12	Frequency Detection Value 1 (FDT2)	0.00Hz~P00.07	50.00Hz	○
P09.13	Frequency Detection 2 Hysteresis Value	0.0%~100.0% (relative to FDT2)	5.0%	○
P09.14	Swing Set Mode	0: Relative to the center frequency	0	●
P09.15	Swing Frequency Amplitude	0.0%: Close swing frequency function 0.1%~100.0%	0.0%	○
P09.16	Jump Frequency Amplitude	0.0%~50.0%	0.0%	○
P09.17	Swing Frequency Rise Time	0.0s~3000.0s	5.0s	○
P09.18	Swing Frequency Fall Time	0.0s~3000.0s	5.0s	○
P09.19	Jump Frequency 1	0.00Hz~P00.07	0.00Hz	○
P09.20	Jump Frequency Amplitude 1	0.00Hz~P00.07	0.00Hz	○
P09.21	Jump Frequency 2	0.00Hz~P00.07	0.00Hz	○
P09.22	Jump Frequency Amplitude 2	0.00Hz~P00.07	0.00Hz	○
P09.23	Jump Frequency Amplitude 3	0.00Hz~P00.07	0.00Hz	○
P09.24	Jump Frequency Amplitude 3	0.00Hz~P00.07	0.00Hz	○
P09.25	Set Length	0~65535	0	○
P09.26	Pulse Per Meter	0.1~6553.5	0	○

P09.27	Set Count Value	P09.28~65535	1000	○
P09.28	Designated Count Value	1~P09.27	500	○
P09.29	Droop Control Frequency Drop Rate	0.00Hz~10.00Hz	0.00Hz	○
P09.30	Accumulative Running Time Reached	0h~65535h	0h	○
P09.31	Accumulative Power-On Time Reached	0h~65535h	0h	○
P09.32	Current Running Time Reached	0min~65535min	0min	○
P09.33	Current Power-On Time Reached	0min~65535min	0min	○
P09.34	Any Frequency Reaching	0.00Hz~P00.07	0.00Hz	○
P09.35	Any Frequency Reaching Detection Amplitude	0.00Hz~P09.34	0.00Hz	○
P09.36	Any Current Reaching	0.0%~300.0%	0.0%	○
P09.37	Any Current Reaching Detection Amplitude	0.0%~P09.36	0.0%	○
P09.38	Electricity Consumption Initial Value Upper Bit	0kwh~60000kwh	0kwh	○
P09.39	Electricity Consumption Initial Value Lower Bit	0.0kwh~999.9kwh	0.0kwh	○
P09.40	Inverter Input Power Factor	0.00~1.00	0.86	○

P09.41	Keypad \wedge V Fine Tuning Frequency and JOG/REV Fast Frequency Set	0x0000~0x1221 LED unit's digit: frequency control selection 0: Adjusting enabled 1: Keypad adjusting disabled LED ten's digit bit: frequency control selection 0: Only enabled when P00.02=1 or P00.03=1 1: All frequency mode are enabled 2: MS speed in priority, disabled for MS speed LED hundred's digit: stop action selection 0: Setup enabled 1: Enabled in run, clear after stop 2: Enabled in run, clear upon receiving stop command LED thousand's digit: \wedge v key integration function 0: Integration function enabled 1: Integration function disabled	0x0000	○
P09.42	\wedge V Key Integration Rate	0.01s~10.0s	1.0s	○

P09.43	UP/DOWN Terminal Control Setup	<p>0x000~0x221</p> <p>LED unit's digit: frequency control selection</p> <p>0: UP/DOWN terminals setting enabled</p> <p>1: UP/DOWN terminals setting Disabled LED ten's digit: frequency control selection</p> <p>0: Only enabled when P00.02=1 or P00.03=1</p> <p>1: All frequency mode are enabled</p> <p>2: When the multi-step speed are priority, it is disabled to the multi-step speed</p> <p>LED hundred's digit: action selection when stop</p> <p>0: Setting enabled</p> <p>1: Enabled in run , clear after stop</p> <p>2: Enabled in run , clear upon receiving stop command</p>	0x0000	○
P09.44	UP/DOWN Terminals Frequency Change Rate	0.01Hz/s ~50.0Hz/s	1.00Hz/s	○
P09.45	Frequency Setting at Power Loss Action Selection	<p>0x000~0x111</p> <p>LED unit's digit: action selection when digital adjustment frequency with power off</p> <p>0: Save when power off</p> <p>1: Clear when power off</p> <p>LED ten's digit: action selection when Modbus setting frequency power off</p> <p>0: Save when power off</p> <p>1: Clear when power off</p> <p>LED hundred's digit: action selection when other Communication set frequency power off</p>	0x000	○

		0: Save when power off 1: Clear when power off		
P09.46	PWM Selection	0x00~0x21 LED unit's digit: PWM mode selection 0: PWM mode 1, PWM mode1, 3phase modulation and 2phase -modulation 1: PWM mode2, three-phase modulation LED ten's digit: PWM low speed carrier limit 0: Low speed carrier limit, carrier limit mode 1 1: Low speed carrier limit, carrier limit mode 2 2: Low speed carrier no-limit	0x01	◎
P09.47	Zero Frequency Output Selection	0: No voltage output 1: Voltage output 2: According to the stop DC braking current output	0	○
P09.48	Action after Accumulative Power-On and Run Time Reached	0: Output terminals action, error alarm 1: Output terminals action, no error alarm	0	○
P09.49	Motor Power Correction Coefficient	0.00%~200.0%	100.0%	○
P09.50	User-Defined Fault Selection	LED unit's digit 0: Disabled run after fault 1: Jog running after fault LED ten's digit 0: Coast to stop 1: Decelerate to stop	0x00	○
P09.55	Jog Preferred Selection	0: Enabled 1: Disabled	0	○
P09.56	Auto-start Selection after Manual Reset	0: Disabled 1: Enabled	0	○

P10 Keyboard Function and Display Parameters Group				
Function Code	Parameter Name	Setting Range	Factory Default Value	Property
P10.00	STOP/RESET Key Stop Function	0: Only enabled to keyboard control panel 1: Enabled to control panel and terminals at the same time 2: Enabled to control panel and communication at the same time 3: Enabled to all control mode	0	○
P10.01	REV/JOG Key Function	0: No function 1: Jog running 2: FWD/REV switchover 3: Coast to stop 4: Clear up/down & ^/v key setup frequency 5: Shift key switchover display state 6: Realize run command pre-set mode according to sequence switchover 7: Quick debugging mode(according to factory parameter debugging) 8: Modify rapidly set frequency	1	◎
P10.02	JOG/REV Key Run Command Channel Switchover Sequential Selection	0: Keyboard control←→terminal control 1: Keyboard control →communication control 2: Terminal control ←→communication control 3: Keyboard control →terminals Control →communication control	3	○

P10.03	LED Running Display Parameter 1	0x0000~0xFFFF BIT0: Running frequency (Hz light on) BIT1: Sett frequency(Hz flash) BIT2: Bus voltage(V light on) BIT3: Output voltage(V light on) BIT4: Output current(A light on) BIT5: Run speed(RPM on) BIT6: Output power(% light on) BIT7: Output torque (% light on) BIT8: PID setting value BIT9: PID Feedback value BIT10: State of input terminals BIT11: State of output terminals BIT12: Torque setting value (% light on) BIT13: Pulse counting value BIT14: Current stage in multi stage-speed BIT15: Slope frequency setting value (Hz light on)	0x003F	○
P10.04	LED Running Display Parameter 2	0x0000~0xFFFF BIT0: Analog AI1 value (V light on) BIT1: Reserved BIT2: Reserved BIT3: Reserved BIT4: Motor overload percentage(% light on) BIT5: Inverter overload percentage(% light on) BIT6: Length BIT7: Excitation current (A	0x0000	○

		<p>light on)</p> <p>BIT8: Torque current (A light on)</p> <p>BIT9: AC input current (A light on)</p> <p>BIT10: User-defined speed 1(running value)</p> <p>BIT11: User-defined speed 2(running value)</p> <p>BIT12~BIT15: Reserved</p>		
P10.05	LED Stop Display	<p>0x0000~0xFFFF</p> <p>BIT0: Set frequency (Hz flash)</p> <p>BIT1: Bus voltage (V light on)</p> <p>BIT2: State of input terminals</p> <p>BIT3: State of output terminals</p> <p>BIT4: PID setting value (% flash)</p> <p>BIT5: PID Feedback value (% on)</p> <p>BIT6: Torque setting value (% on)</p> <p>BIT7: Analog AI1 (V light on)</p> <p>BIT8: Reserved</p> <p>BIT9: Reserved</p> <p>BIT10: Reserved</p> <p>BIT11: Current stage in multi stage-speed</p> <p>BIT12: Pulse count value</p> <p>BIT13: User-defined speed 1(setting value)</p> <p>BIT14: User-defined speed 2(setting value)</p> <p>BIT15: Length</p>	0x03	○
P10.06	User-Defined Speed 1 Coefficient	<p>0.00~60.00</p> <p>User-defined speed= Running frequency*P10.06</p>	1.00	○

P10.07	User-Defined Speed 2 Coefficient	0.00~60.00 User-defined speed=mechanic RPM*P10.07	1.00	<input type="radio"/>
P10.09	LED Running Display Parameter in Second Line	0~15: Corresponding bit0~bit15 of P10.03 16~31: Corresponding bit0~bit15 of P10.04	4	<input type="radio"/>
P10.10	LED Stop Display Parameter in Second Line	0~15: Corresponding bit0~bit15 of P10.03	1	<input type="radio"/>
P11 MS Speed Parameters Group				
Function Code	Parameter Name	Setting Range	Factory Default Value	Property
P11.00	The frequency of Paragraph 0	-100.0%~100.0%	0.0%	<input type="radio"/>
P11.01	The frequency of Paragraph 1	-100.0%~100.0%	0.0%	<input type="radio"/>
P11.02	The frequency of Paragraph 2	-100.0%~100.0%	0.0%	<input type="radio"/>
P11.03	The frequency of Paragraph 3	-100.0%~100.0%	0.0%	<input type="radio"/>
P11.04	The frequency of Paragraph 4	-100.0%~100.0%	0.0%	<input type="radio"/>
P11.05	The frequency of Paragraph 5	-100.0%~100.0%	0.0%	<input type="radio"/>
P11.06	The frequency of Paragraph 6	-100.0%~100.0%	0.0%	<input type="radio"/>
P11.07	The frequency of Paragraph 7	-100.0%~100.0%	0.0%	<input type="radio"/>
P11.08	The frequency of Paragraph 8	-100.0%~100.0%	0.0%	<input type="radio"/>
P11.09	The frequency of Paragraph 9	-100.0%~100.0%	0.0%	<input type="radio"/>
P11.10	The frequency of Paragraph 10	-100.0%~100.0%	0.0%	<input type="radio"/>

P11.11	The frequency of Paragraph 11	-100.0%~100.0%	0.0%	<input type="radio"/>
P11.12	The frequency of Paragraph 12	-100.0%~100.0%	0.0%	<input type="radio"/>
P11.13	The frequency of Paragraph 13	-100.0%~100.0%	0.0%	<input type="radio"/>
P11.14	The frequency of Paragraph 14	-100.0%~100.0%	0.0%	<input type="radio"/>
P11.15	The frequency of Paragraph 15	-100.0%~100.0%	0.0%	<input type="radio"/>
P13 Protection Function Parameters Group				
Function Code	Parameter Name	Setting Range	Factory Default Value	Property
P13.00	Motor Overload Protection Selection	0: Disabled 1: Ordinary motor(with low speed compensation) 2: Variable frequency motor (without low speed compensation)	1	<input type="radio"/>
P13.01	Motor Overload Protection Factor	20.0%~200.0%	100.0%	<input type="radio"/>
P13.04	Overload Warning Detection level	50%~200%	G: 150%	<input type="radio"/>
			P: 120%	
P13.05	Overload Warning Detection Time	0.0s~3600.0s	1.0s	<input type="radio"/>
P13.06	Offload Warning Detection level	0%~P13.04	50%	<input type="radio"/>
P13.07	Offload Warning Detection Time	0.0s~3600.0s	1.0s	<input type="radio"/>

P13.08	Inverter or Motor Overload/Offload Warning Selection	0x000~0x131 Led unit's digit: 0: Motor overload/offload warning, relative to the rated current of the motor 1: Inverter overload/offload warning, relative to the rated current of inverter Led ten's digit: 0: Inverter continues to work after overload/offload warning 1: Inverter continues to work after offload warning and stop to run after overload warning 2: Inverter continues to work after overload alarm and stop to run after offload warning 3: Inverter stops after offload/overload warning Led hundred's digit: 0: Detection all the time 1: Detection in the constant speed run	0x000	<input type="radio"/>
P13.09	Output Over-current Detection Value	0.0%: No detection 0.1%~300.0%	0.0%	<input type="radio"/>
P13.10	Output Over-current Detection Time	0.0s~100.0s	0.0s	<input type="radio"/>
P13.11	Output Over-current Action	0: Terminal output 1: Terminal output, alarm Er016 2: Terminal output, alarm Er016 when constant speed run 3: Terminal output in the constant speed run	0	<input type="radio"/>
P13.12	Overvoltage Stall Protective	0: Disabled 1: Enabled	0	<input type="radio"/>
P13.13	Overvoltage Stall	120%~150%	380VAC: 140%	<input type="radio"/>

	Protective Voltage	(standard bus voltage)	220VAC: 120%	
P13.14	Dynamic Brake Enabled	0: Disabled 1: Enabled	1	○
P13.15	Dynamic Brake Voltage	200.0VDC~2000.0VDC	220VAC: 380.0VDC	○
			380VAC: 700.0VDC	
			660VAC: 1120VDC	
P13.16	Current Limit Selection	0x00~0x11 Unit's digit: current limiting action selection 0: Current limiting action disabled 1: Current limiting action Enabled Ten's digit: hardware current limiting overload alarm selection 0: Hardware current limiting overload alarm enabled 1: Hardware current limiting overload alarm disabled	0x01	◎
P13.17	Auto Current Limit Level	50.0%~200.0%	G type: 160.0%	◎
			P type: 120.0%	
P13.18	Frequency Droop Rate When Current Limiting	0.00Hz/s ~50.00Hz/s	10.00Hz/s	◎
P13.19	Phase Loss Protection	0x00~0x11 Led unit's digit: 0: Input phase loss protection disabled 1: Input phase loss protection enabled Led ten's digit: 0: Output phase loss protection disabled 1: Output phase loss protection enabled Remark: the machine less	0x11	○

		than 11kW have no input phase loss protection			
P13.20	Frequency Reduction Function Selection when an Instantaneous Power Failure	0: Disabled 1: Enabled		0	<input type="radio"/>
P13.21	Frequency Reduction Mode Selection when an Instantaneous Power Failure	0~1		10.0s	<input type="radio"/>
P13.22	Frequency Decrease Rate when an Instantaneous Power Failure (P13.21=0 Enabled)	0.00Hz/s~50.00Hz/s		10.00Hz/s	<input type="radio"/>
P13.23	Deceleration Time when an Instantaneous Power Failure (P13.21=1 Enabled)	0.0s~600.0s		5.0s	<input type="radio"/>
P13.24	Estimate Voltage when an Instantaneous Power Failure	200.0VDC~600.0VDC	380VAC: 420.0VDC	<input type="radio"/>	
			220VAC: 240.0VDC	<input type="radio"/>	
P13.25	Short-circuit to Ground Upon Power-on	0: Enabled 1: Disabled		0	<input type="radio"/>
P13.26	Fault Output Terminals Action Selection during Fault	0x00~0x11 Led unit's digit: 0: Action upon under-voltage error 1: No action upon under-voltage error Led ten's digit: 0: Action during auto reset 1: No action during auto reset		0x00	<input type="radio"/>
P13.27	Fault Auto Reset Time	0~20		0	<input type="radio"/>
P13.28	Time Interval of Fault Reset	0.1s~3600.0s		1.0s	<input type="radio"/>

P13.29	Fan Start Mode	0: Automatic control 1: Fan keep run		0	○
P13.30	Automatic Frequency Reduction Selection when Voltage Reduction	0: Disabled 1: Enabled		0	○
P13.31	Automatic Frequency Reduction Point when Voltage Reduction	200.0V~600.0V	380VAC: 513.0VDC	○	
			220VAC: 297.0VDC		
P13.32	Emergency Stop Time	0.0s~3600.0s		5.0s	○
P14 Failure Record Parameter Group					
Function Code	Parameter Name	Setting Range		Factory Default Value	Property
P14.00	Fault Record Selection	0~3 (0: current fault, 1: Last fault, ID is larger, the earliest failure)		0	○
P14.01	Fault Code	0: No fault Er001: Acceleration run over current (hardware) Er002: Deceleration run over current (hardware) Er003: Constant speed run over current (hardware) Er004: Acceleration run over current (software) Er005: Deceleration run over current (software) Er006: Constant speed run over current (software) Er007: Acceleration run overvoltage Er008: Deceleration run overvoltage Er009: Constant speed run overvoltage Er010: Bus under voltage Er011: Motor overload Er012: Inverter overload		0	●

		Er013: Input side phase loss Er014: Output side phase loss Er015: Module overheat Er016: Current over-limit fault Er017: External fault Er018: Communication fault Er019: Current detection circuit fault Er020: Motor self-learning fault Er021: EEPROM read-write fault Er022: PID feedback over limit fault Er023: PID feedback break line fault Er024: Short circuit to ground upon power on Er025: Reserved Er026: Reserved Er027: Running time reached Er028: power-on time reached Er029: Offload Er030~Er035: Reserved Er036: Electronic overload Er037: User-defined fault Er041: User-defined fault 1 Er042~ Er044: Reserved Er060: Manufacturer defined fault 1 Er061: Manufacturer defined fault 2		
P14.02	Run Frequency upon Fault	0.00Hz~650.00Hz	0.00Hz	●
P14.03	Current Upon Fault	0.0A~2000.0A	0.0A	●
P14.04	Output Voltage upon Fault	0V~2000V	0V	●

P14.05	Bus Voltage upon Fault	0.0V~2000.0V	0.0V	●
P14.06	Input Terminal State upon Fault	0x00~0x3F	0x00	●
P14.07	Output Terminal State upon Fault	0x00~0x1F	0x00	●
P14.08	Inverter Temperature upon Fault	-20.0°C ~120.0°C	0.0°C	●
P14.09	Run Time upon Fault	0min~65535min	0min	●
P14.10	Power-On Time upon Fault	0min~65535min	0min	●
P14.11	Accumulative Running Time upon Fault	0h~65535h	0h	●
P14.12	Accumulative Power-On Time upon Fault	0h~65535h	0h	●
P15 Communication Parameters Group				
Function Code	Parameter Name	Setting Range	Factory Default Value	Property
P15.00	Communication Protocol Selection	0: Modbus	0	●
P15.01	Local Address	0: Broadcasting address 1~247: slave address	1	○
P15.02	Baud Rate	0: 1200bps 1: 2400bps 2: 4800bps 3: 9600bps 4: 19200bps	3	○

P15.03	Data Format	0: No check (N,8,1)for RTU 1: Even parity check (E,8,1)for RTU 2: Odd parity check (O,8,1)for RTU 3: No check (N,8,2)for RTU 4: Even parity check (E,8,2)for RTU 5: Odd parity check (O,8,2)for RTU	0	○
P15.04	Response Delay	0ms~200ms	5ms	○
P15.05	Communication Timeout Detection Time	0.0s: No detection 0.1s~100.0s	0.0s	○
P15.06	Transmission Error Handling	0: Alarm and coast to stop 1: No alarm and continue to run 2: No alarm and stop according to the stop mode(only under the communication control mode) 3: No alarm and stop according to the stop mode (under all control mode)	0	○
P15.07	Communication Processing Action Selection	0x00~0x11 Led unit's digit: 0: Write with responds 1: Write without responds Led ten's digit: 0: Communication encrypting no limit 1: Communication encrypting with limit	0x00	○
P15.08	Communication to Modify P00.01 Selection	0: Enable modify 1: Disable modify	1	○

P28 Status Monitoring Parameter Group				
Function Code	Parameter Name	Setting Range	Factory Default Value	Property
P28.00	Running Frequency		0.01Hz	●
P28.01	Setting Frequency		0.01Hz	●
P28.02	Slop Given Frequency		0.01Hz	●
P28.03	Bus Voltage		0.1V	●
P28.04	Output Voltage		1V	●
P28.05	Output Current		0.1A	●
P28.06	Torque Current		0.1A	●
P28.07	Excitation Current		0.1A	●
P28.08	Output Power Percent		0.1%	●
P28.09	Output Torque		0.1Nm	●
P28.10	Output Torque Percent		0.1%	●
P28.11	Set Torque Percent		0.1%	●
P28.12	Motor Running RPM		1RPM	●
P28.13	Speed Controller Output		0.1%	●
P28.14	DI Input State		1	●
P28.15	DO Input State		1	●
P28.16	AI1 Voltage		0.01V	●
P28.19	Count Value		1	●
P28.20	Motor Power Factor		0.01	●
P28.21	Magnetic Linkage		0.1%	●
P28.22	PID Setting Value		0.1	●
P28.23	PID Feedback Value		0.1	●
P28.24	PID Output Value		0.1%	●

P28.27	Current Fault Code		0	●
P28.28	Accumulative Running Time		1h	●
P28.29	Accumulative Power-On Time		1h	●
P28.30	Current Running Time		1min	●
P28.31	Current Power-On Time		1min	●
P28.32	Module Temperature		0.1°C	●
P28.34	Frequency Fine-Tuning		0.01Hz	●
P28.35	AC Input Current		0.1A	●
P28.36	Accumulative Power Consumption Upper Bit		1kwh	●
P28.37	Accumulative Power Consumption Lower Bit		0.1wh	●
P28.38	Length		0	●
P28.39	Accumulative Running Time		0	●
P28.40	Torque Compensation		0.1%	●
P29 User Parameters Group				
Function Code	Parameter Name	Setting Range	Factory Default Value	Property
P29.00	User Password	0~65535	0	○
P29.01	Parameter Initialization	0: No operation 1: Restore factory default setup value 2: Clear the fault record 3: Clear accumulative running and power-on time	0	◎
P29.02	Product type	0~65535	Factory Setting	●

P29.03	Software version	1.00~10.00	Factory Setting	●
P29.04	Inverter rated power	0.4kW ~1000.0kW	Factory Setting	●
P29.05	Inverter Rated Voltage	220V~1140V	Factory Setting	●
P29.06	Inverter Rated Current	2.4A~2000.0A	Factory Setting	●
P29.07	Ex Factory Date (year/month)		Factory Setting	●
P29.08	Ex Factory Date (day)		Factory Setting	●
P29.09	Factory Use			☆
P29.10	Factory Use			☆
P29.11	Factory Use			☆
P30 Factory Parameters Group				

Chapter 6 Parameter Description

6.1 P00 Basic Function

P00.00	Motor Running Mode	0: V/F control mode 1: Sensor-less vector control mode 0 2: Sensor-less vector control mode 1	0	◎
--------	--------------------	---	---	---

Select inverter run mode, V/F control mode can be selected by P04.00 or P21.00 parameter to choose linear V/F, MS V/F, curve V/F or V/F separation control.

V/F control mode:

One unit of inverter can work with several units of motor, no need to install encoder. It is adaptive to non-high requirement on dynamic response application, as belt conveyor, textile machinery etc. Vector V/F improve further V/F control performance.

Sensor-less vector control mode 0:

One unit of inverter work with one unit of motor, no need to install encoder. It is adaptive to high performance requirement application, featured with torque precision high and torque response quick.

Sensor-less vector control mode 1:

One unit of inverter work with one unit of motor, no need to install encoder. It is highly adaptive to application, especially when motor power is big and controlling performance is better.

P00.01	Running Command Source	0: Keyboard command source (L/R OFF) 1: Terminal command source (L/R ON) 2: Serial port command source (L/R flashes)	0	○
--------	------------------------	--	---	---

Select inverter run command source:

Inverter run command include: start, stop, forward run, reverse run, jog.

Keypad command channel:

Key" RUN, STOP/RESET" on keypad to realize start, stop, fault reset command.

Terminal command channel:

Through multi-function input terminal to realize forward, reverse, forward jogging, reverse jogging etc. control command, refer to P05 function code group.

Communication command channel:

Operation command as setup via HOST PC via communication, refer to P15 function code group.

P00.02	Frequency Command Source A	0: Keypad potentiometer setting 1: Function code P00.11 setting 2: AI1 3: Reserved 4: Reserved 5: Reserved 6: Multi-stage speed running 7: Reserved 8: PID control setting 9: Communication setting	0	⊙
P00.03	Frequency Command Source B	0: Keypad potentiometer setting 1: Function code P00.11 setting 2: AI1 3: Reserved 4: Reserved 5: Reserved 6: Multi-stage speed running 7: Reserved 8: PID control setting 9: Communication setting	4	⊙

Separately choose A, B group frequency command source (note: A, B channel cannot choose the same frequency command source):

Keypad potentiometer setup:

Via potentiometer on rotating panel to change given frequency, can adjust from 0.00Hz to max output frequency P00.07.

Also via keypad $\frac{1}{v}$ key or terminal UP/DOWN action to realize frequency command fine tuning, refer to function code P09.41~P09.44.

1: Function code P00.11 setting

Via set function code P00.11 directly set target frequency

2: AI1 setting

Via analog set frequency command, AI1 support voltage or current input. The relation of AI input voltage(current) and set frequency can be set flexible, refer to function code P05.18~P05.26

7: MS speed input (optional)

Via 4 digits DI input(refer to function code P05) to randomly select one from 16 frequency command as target frequency, refer to function code P11.

HS pulse input set:

Via HD11 terminal input pulse frequency to set target frequency, support 0.00kHz~100.00kHz pulse input, refer to function code P05.39~P05.43

8: PID control setting:

Select process PID control as frequency source, generally used in processing close-loop control, such as pressure close-loop, temperature close-loop, refer to function code P08.

9: Communication setting:

Frequency set is given by HOST PC communication directly, refer to function code P15 and communication protocol.

P00.04	Frequency Source Superposition	0: K1*frequency instruction A 1: K2*frequency instruction B 2: K1*frequency instruction A+K2*frequency instruction B 3: K1*frequency instruction A-K2*frequency instruction B 4: MAX (K1*frequency instruction A, K2*frequency instruction B) 5: MIN (K1*frequency instruction A, K2*frequency instruction B) Remark: K1: P00.29 K2: P00.30	0	○
--------	--------------------------------	---	---	---

Via P00.04 select A, B frequency channel Superposition mode, to realize complicate frequency command preset:

Can separately realize single channel A, single channel B, the sum of two channel, the difference of two channel, the max of the two channel, the min of the two channel.

P00.05	Rang of Frequency Command Source B	0: Relative to maximum frequency 1: Relative to frequency source A	0	○
--------	------------------------------------	---	---	---

When B channel work with frequency command integration, through P00.05 and P00.06 to adjust B channel frequency command reference range. If choose frequency source A channel, then frequency source B changes accompanied frequency source A change.

P00.06	Frequency output lower limit after superposition	-100%~100%(100% corresponding to P00.07)	0.0%	◎
--------	--	--	------	---

P00.06 is used to set the frequency output lower limit after superposition. The value is less than or equal to the upper limit frequency, when the set frequency is lower than the frequency output lower limit after superposition, then operation by lower limit frequency.

P00.07	Max Output Frequency	P00.09~650.00Hz	50.00Hz	◎
--------	----------------------	-----------------	---------	---

Max frequency is the reference of all frequency relative quantity, as pulse input, analog terminal, MS speed etc. Each of the percentage is relative to the max output frequency. Such as analog input 10V, change into 100%, relative (100% \times P00.07)Hz.

Note: Output frequency of all operation will not exceed max output frequency.

P00.09	Running Frequency Upper Limit	P00.10~P00.07	50.00Hz	○
--------	-------------------------------	---------------	---------	---

P00.10	Running Frequency Upper Limit	0.00Hz~P00.09	0.00Hz	<input type="radio"/>
--------	-------------------------------	---------------	--------	-----------------------

P00.09 is used to set running frequency upper limit. The value is less or equal to max output frequency, when set frequency is higher than upper limit frequency then it runs with upper limit frequency.

P00.10 is used to set running frequency lower limit. The value is less or equal to upper limit frequency, when set frequency is lower than lower limit frequency and bigger than 0, then P01.20 can be used to setup inverter run mode.

P00.11	Keypad Set Frequency	0.00Hz~P00.07	50.00Hz	<input type="radio"/>
--------	----------------------	---------------	---------	-----------------------

When A or B frequency command channel select function code P00.11 setup, this function code value directly used as its channel frequency command.

P00.12	Multi-stage Speed Command Source Section 0	0: Function code P11.00 1: Function code P00.11 2: AI1 3: Reserved 4: Reserved 5: Rapid pulse 6: PID control setup	0	<input checked="" type="radio"/>
--------	--	--	---	----------------------------------

Selecting MS speed command speed 0 command source, can be set by function code P11.00, also by analog preset to realize flexible adjusting. Refer to P11 MS speed parameter.

P00.14	Acceleration Time 0	0.00s~3600.00s	Model dependent	<input type="radio"/>
P00.15	Deceleration Time 0	0.00s~3600.00s	Model dependent	<input type="radio"/>

Acceleration/deceleration time means time needed if the inverter Acceleration from 0.00Hz to the reference frequency (P00.16). It is used to set frequency changing slope.

P00.16	Acceleration/Deceleration Time Reference Frequency	0: Max output frequency 1: Set frequency	0	<input checked="" type="radio"/>
--------	--	---	---	----------------------------------

Via selecting acceleration/deceleration time unit to change the setting max range of Acceleration/down time to meet different requirement.

Acceleration/deceleration time means the time needed if the inverter acceleration/deceleration to reference frequency, via changing P00.16 to change frequency acceleration/deceleration slope ratio. When P00.16=1, the time needed from zero frequency acceleration/ deceleration to setting frequency is the setting acceleration/ deceleration time.

P00.17	Rotation Direction	0: Same Direction 1: Reverse Direction	0	<input type="radio"/>
P00.18	Reverse Control	0: Allow reverse 1: Forbid reverse	0	<input type="radio"/>

P00.17 is used to regulate the forward rotation of motor, the same purpose as change any phase of output U, V, W sequence.

P00.18 can set if motor reverse rotating is permitted, to avoid motor reverse rotating causing equipment damage in some application.



WARNING

- When motor run is reverse with actual required, then can randomly change two lines sequence among U, V, W to change motor run direction. Prohibit to use software to setup the motor run direction.

P00.19	Carrier Frequency Setting	1.0kHz~16.0kHz	Model dependent	<input type="radio"/>
--------	---------------------------	----------------	-----------------	-----------------------

Carrier frequency has important effect to inverter and motor, when carrier frequency rising, the power loss, temperature rising, noise of motor will decrease; when carrier frequency decreasing, inverter temperature will decrease. The leakage current of motor and radiation interference will decrease.

P00.21	Parameter Lockup Selection	0: Parameter lockup disabled 1: Parameter lockup enabled and other parameters cannot be changed except the current one 2: Not permitted to operate parameter initializing function code	0	<input type="radio"/>
--------	----------------------------	---	---	-----------------------

When set this parameter as 1 (lock all parameter), except this function code, any function code is not permitted to be changed, preventing user wrong operation. Set the parameter as 2, only locking parameter not been initialized, as P29.01 cannot be set as 1, preventing user from initializing parameter. If the parameter set as 0, user can randomly change function code.

P00.23	Motor Parameter Self-learning	0: No operation 1: Dynamic self-learning 2: Comprehensive static self-learning 3: Rapid static self-learning	0	⊙
--------	-------------------------------	---	---	---

If select SVC operation, must get motor parameter dynamic self-learning. If carry out motor parameter dynamic self-learning, motor must get off with load or light load, if not, will increase error so cannot acquiring more precision motor parameter.

P00.24	AVR Function Selection	0: Disabled 1: Enabled	1	○
--------	------------------------	---------------------------	---	---

Inverter output voltage will automatically adjust function, to eliminate the effect of bus voltage fluctuation to inverter output voltage.

P00.25	Over Modulation Selection	0x00~0x11 Unit's digit of LED: 0: Over modulation disabled 1: Over modulation enabled Ten's digit of LED: 0: Mild over modulation 1: Depth over modulation	0X01	⊙
--------	---------------------------	--	------	---

The function is used as boost inverter output voltage properly, in general condition user has no need to adjust the parameter.

P00.28	Load Type Selection(Only Enabled For V/F)	Unit's digit of LED: motor 1 load type selection 0: Non-inertia load 1: Inertia load Ten's digit of LED: motor 2 load type selection 0: Non-inertia load 1: Inertia load	0x00	⊙
--------	---	---	------	---

This function is used when inverter running in V/F mode and selecting load motor load type.

P00.29	K1 Coefficient	0.000~20.000	1.000	○
P00.30	K2 Coefficient	0.000~20.000	1.000	○

This function is used P00.04 frequency source superposition.

6.2 P01 Start Stop Control Parameter Group

P01.00	Start Running Mode	0: Directly start 1: DC braking restart	0	⊙
--------	--------------------	--	---	---

Set motor start mode:

Start with starting frequency:

Firstly operating a period with setup start frequency and start frequency keep time, then acceleration/deceleration operate according to acceleration/deceleration time setup slope. Refer to P01.01 Firstly DC braking first then start:

According to current value and retention time, keep DC current for a while, then start 0 mode.

Speed tracking start:

Inverter firstly check motor RPM, then detect motor RPM start.

P01.01	Directly Start Initial Frequency	0.00Hz~10.00Hz	0.50Hz	⊙
P01.02	Initial Frequency Holding Time	0.0s~60.0s	0.0s	⊙

Start frequency is the initial frequency when inverter starting, as below diagram showed, start frequency retention time is the run time under start frequency. Start frequency generally set 1Hz~2Hz.

In low power application, by setting start frequency can quickly build slip, which is helpful in quickly start motor. For big power or heavy load application, properly extend start frequency retention time, can pre-excitation motor and reduce start current and boost start torque. If motor is rotating when start, can make motor speed getting low then Acceleration later.

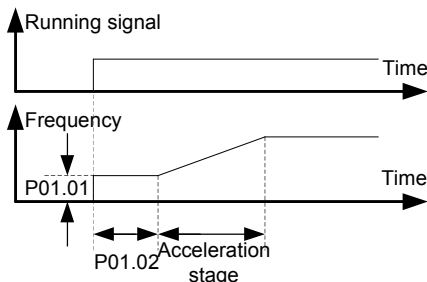

Fig 6.2-1 Schematic diagram for startup frequency

P01.03	DC Braking Current Before Start	0.0%~100.0% (100% corresponding inverter rated current)	0.0%	⊙
P01.04	DC Braking Time Before Start	0.00s~60.00s	0.00s	⊙

The DC brake before starting is the DC current before motor rotating output for in a period, P01.03 set input DC current value, 100.0% is relative to inverter rate current. P01.04 set the time of DC input. Through input DC current to realize the magnetic brake and pre-excitation of motor. For big power and heavy load application, via pre-excitation, start torque get bigger, impact current get smaller.

DC brake before start process as below diagram:

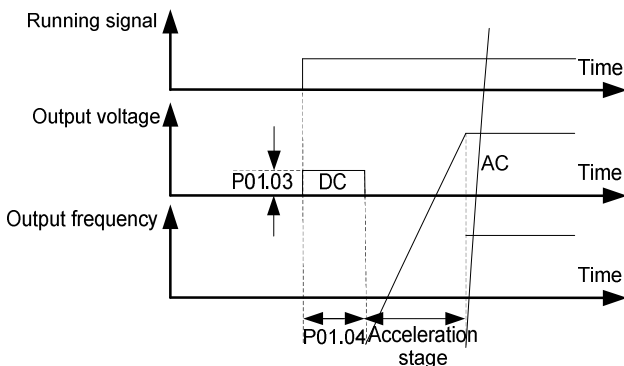

Fig 6.2-2 Schematic diagram for the braking current before starting

P01.05	Stop Mode Selection	0: Deceleration stop 1: Random stop	0	○
--------	---------------------	--	---	---

Deceleration to stop: Deceleration to stop is motor relying on inverter braking, under set Deceleration time reducing to zero. Different application can adopt different stop mode.

Coast to stop: Coast to stop is inverter cut off motor current after receiving stop command, motor relying its inertia reduce speed to zero.

⚠ DANGER

After coast to stop, the motor is still in the high speed rotation, to prevent equipment damage or personal injury caused by!

P01.06	Initial Frequency of Stop DC Braking	0.00Hz ~P00.07	0.00Hz	○
P01.07	Waiting Time of Stop DC Braking	0.00s~60.00s	0.001s	○
P01.08	Stop DC Braking Current	0.0%~100.0% (100% corresponding inverter rated current)	0.0%	○
P01.09	Stop DC Braking Time	0.00s~60.00s	0.00s	○

During deceleration process, if frequency reducing to P01.06, waiting P01.07 setup time, starting input DC current to motor, acceleration braking. The input current value is set by P01.08, 100.0% is equal to rate inverter current, input DC current time is set by P01.09, if braking time is 0, then no need this process. Such as below diagram:

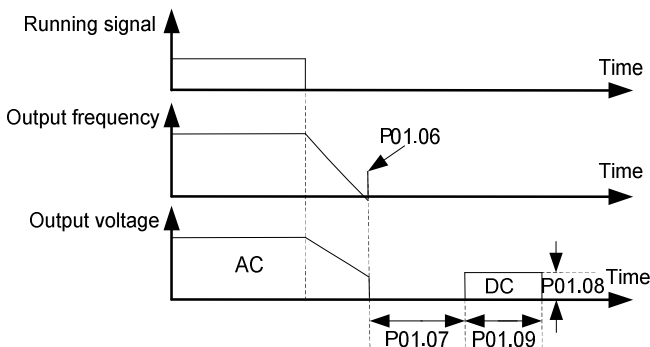

Fig6.2-3 Schematic diagram for DC brake time at stop

DC braking stage, motor rotator maintains certain holding power, preventing rotator no steady or wriggle after stop.

P01.10	Excitation Braking Coefficient	0: Disabled 100~150: The greater the coefficient, the greater the braking intensity	0	○
--------	--------------------------------	--	---	---

Inverter can make motor quickly reducing speed by increase motor magnetic flux. By increasing motor magnetic flux, motor generated energy in braking can be transformed to heat.

Magnetic flux can be used in motor stop, can also be used in changing motor speed. Its feature: brake once stopped, no need to wait magnetic flux weak then brake;

furthermore, motor cooling effect is better, during excitation brake period, motor stator current increase, rotor current not increase, and stator cooling is faster than rotor.

P01.11	Short-circuit Braking Current	0.0%~150% (100% corresponding inverter rate current)	0.0%	○
P01.12	Startup Short-circuit Braking Holding Time	0.00s~60.00s	0.00S	○
P01.13	Stop Short-circuit Braking Holding Time	0.00s~60.00s	0.00S	○

When the parameter value is set to a non 0, inverter output in start and stop is equivalent to get short circuit of U, V, W motor output.

P01.12 and P01.13 separately used to set start or stop short circuit brake retention time.

P01.14	Switchover Mode between FWD/REV Rotation	0: Switchover with zero frequency 1: Switchover with over starting frequency 2: Switchover at stop speed reach and delay	0	◎
P01.15	FWD/REV Rotation Dead-zone Time	0.0s~3600.0s	0.0s	○

When motor is switchover to reverse direction, can select direct over-zero frequency switchover, can also select start frequency switchover, or after motor reduce to 0 speed then switchover through forward/reverse dead zone time. As below diagram showed:

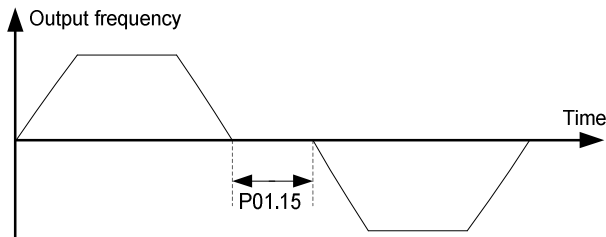

Fig 6.2-4 Schematic diagram for Dead time of FWD/REV rotation

P01.16	Stop Speed	0.00Hz~100.00Hz	0.50Hz	⊙
P01.17	Detection Mode of Stop Speed	0: Detect according to speed set value (no stop delay) 1: Detect according to speed feedback (only enabled for vector control)	0	⊙
P01.18	Detection Time of Feedback Speed	0.00s~100.00 s (only enable to P01.17=1)	0.50S	⊙
P01.19	Delay Time of Delay Time	0.0s~100.0s	0.0S	○

When the inverter output frequency to slow down to stop the speed and frequency inverter downtime (blockade output), motor inertia parking.

When the motor run mode set to vector control, and P01.17 is set to 1, less than P01.16 actual output frequency of frequency converter, and P01.18 set time detection, frequency converter downtime; Otherwise, keep the inverter stop speed and delay P01.19 set by time after downtime.

P01.20	Running Frequency Lower than Frequency Lower Limit Action	0: Running with frequency lower limit 1: Stop 2: Dormant standby	0	⊙
--------	---	--	---	---

When the frequency lower limit of frequency inverter set greater than zero, P01.20 is used to set the frequency inverter run state when inverter real output frequency is lower than the in frequency lower limit.

P01.21	Dormant Recover Delay Time	0.0s~3600.0s(corresponding P01.20=2)	0.0s	○
P01.22	Power-on Terminal Running Protection Selection	0: Terminal operation command is disabled when power on 1: Terminal operation command is enabled when power on	0	○

The terminal run command is disabled:

when the inverter is power on, if the terminal has been effective, after power on, the inverter will not response terminals run commands, run to terminal is Disabled after a period of time, frequency converter to run normal response to a terminal. In addition, when the inverter after failure occurs, terminal operation command must be disabled for a period of time, otherwise the frequency converter does not respond to run terminal.

The terminal run command is enabled:

When the inverter is power on or failure, terminals have been effectively run the command, the inverter will run according to the terminal, start the motor run directly. This situation may lead to the non expected results or dangerous.

P01.23	Restart Selection Upon Power Failure	0: Disabled restart 1: Allow restart	0	○
P01.24	Waiting Time of Restart Upon Power Failure	0.0s~3600.0s (corresponding P01.23=1 effective)	1.0s	○
P01.25	Start Delay Time	0.0s~60.0s	0.0s	◎

When the inverter power failure, after power on gain, whether the inverter automatically start running. If we need inverter's automatic running function after power failure, it must satisfy the restart waiting time set by the P01.24 plus the start delay time set by P01.25, then the inverter can be start and running.

6.3 P02 Motor 1 Parameters

P02.00	Motor Type Selection	0: Asynchronous motor	0	●
P02.01	Asynchronous Motor Rated Power	0.4kW~7.5kW	Model dependent	◎
P02.02	Asynchronous Motor Rated Voltage	0V~400V	Model dependent	◎
P02.03	Asynchronous Motor Rated Current	0.0A~50.0A	Model dependent	◎
P02.04	Asynchronous Motor Rated Frequency	0.00Hz~650.00Hz	Model dependent	◎
P02.05	Asynchronous Motor Rated RPM	0RPM~65535RPM	Model dependent	◎

Caution: above parameter is setting motor 1 General asynchronous machine, user input motor nameplate parameter in inverter.

Note: The power of asynchronous motor should match with the inverter power class. Generally the operating motor power is higher one class than inverter power, or motor power is smaller two standard class than inverter power. Otherwise the control performance will be decreased.

P02.06	Asynchronous Motor Stator Resistance	0.000Ω~65.535Ω	Model dependent	○
P02.07	Asynchronous Motor Rotor Resistance	0.000Ω~65.535Ω	Model dependent	○
P02.08	Asynchronous Motor Rotor and Stator Leakage Inductive Reactance	0.0mH~6553.5mH	Model dependent	○
P02.09	Asynchronous Motor Rotor and Stator Mutual Inductive Reactance	0.0mH~6553.5mH	Model dependent	○
P02.10	Asynchronous Motor No-load Current	0.0A~P02.03 (motor rated current)	Model dependent	○

Above parameter is the motor 1 mathematics mode detail parameter, don't need user manual set. When users change motor nameplate parameter or doing identification, above parameter will update automatically. If user have knew motor model parameter, then no need doing parameter identification, can be manual input. The mathematical model of single phase motor as below diagram showed:

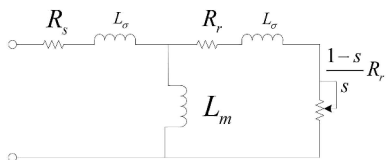

Fig 6.3-1 Schematic Diagram for mathematical model of single phase motor

6.4 P03 Motor 1 Vector Control Parameters Group

P03.00	Speed/Torque Control Selection	0: Speed control 1: Torque control	0	⊙
P03.01	Speed Loop Proportion Gain 1	0~200.0	Vector 0: 10.0	○
			Vector 1: 20.0	
P03.02	Speed Loop Integral Time 1	0.000s~10.000s	0.200s	○
P03.03	Switchover Low Point Frequency	0.00Hz~P03.06	5.00Hz	○
P03.04	Speed Loop Proportional Gain 2	0~200.0	Vector 0: 10.0	○
			Vector 1: 20.0	
P03.05	Speed Loop Integral Time 2	0.000s~10.000s	0.100s	○
P03.06	Switchover High Point Frequency	P03.03~P00.07	10.00Hz	○

Above parameter setup vector control speed loop PI parameter, can set two groups of parameter and separately used for low frequency and high frequency operation. The two groups of parameters can be smoothly switchover according to switchover frequency 1 and switchover frequency 2, as below diagram showed.

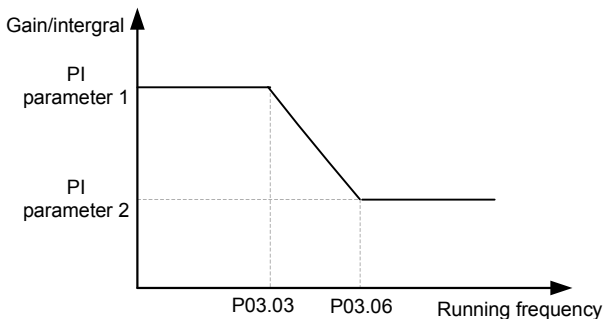

Fig 6.4-1 Schematic Diagram for speed loop parameter switchover

Speed loop proportion gain (P03.01、 P03.04):

Please according to load inertia of motor to adjust the parameters, for larger inertia load, please increase the proportional gain. For small inertia load, reduced the proportional gain. When the rate of speed loop gain slants big, although the response speed is faster, but may occur motor speed oscillation and overshoot. On the contrary, if the proportional gain ratio is too small, the control response becomes slow, so speed adjusting to the stable value is too long. As shown in figure 6.4-1.

Speed loop integral time (P03.02、 P03.05) :

Same as the proportional gain, the speed loop integral time is short, fast control response, but if it is too small may lead to oscillation and instability. When the integration time is large, the control response is slow, speed deviation elimination is getting longer. So all requirements will be appropriately adjusted based on actual situation. As shown in the figure below:

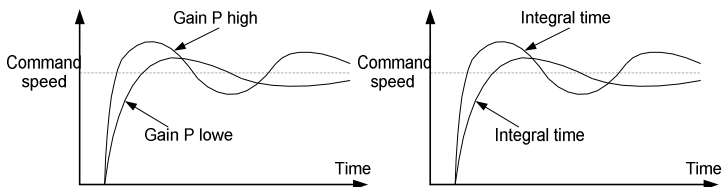

Fig 6.4-2 Schematic Diagram for speed loop PI parameter

P03.07	Speed Loop Output Filter	0~8(corresponding 0~2 ⁸ /10ms)	0	<input type="radio"/>
--------	--------------------------	---	---	-----------------------

Speed loop output filter: speed loop output via first-order filter was sent to current controller, by increasing this filter to decrease the output current ripple, but dynamic response will be slow down.

P03.08	Vector Control Slip Compensation Coefficient (Motoring Condition)	50%~200%	100%	<input type="radio"/>
P03.09	Vector Control Slip Compensation Coefficient (Generating Condition)	50%~200%	100%	<input type="radio"/>

Slip compensation factor is used in adjusting vector control slip frequency, to improve system speed control precision, properly adjust the parameter, can effectively suppress speed offset.

P03.10	Current Loop Proportion Coefficient P	0~60000	1000	<input type="radio"/>
P03.11	Current Loop Integral Coefficient I	0~60000	1000	<input type="radio"/>

Above current loop PI adjusting parameter is only applied for vector control mode 1.

! WARNING

The two parameters in PI adjustments of the current loop, it directly affect the

system's dynamic response speed and control precision, in general case, the user does not need to adjust.

P03.12	Torque Setting Mode Selection	0: Function code P03.13 1: AI1 2: Reserved 3: Reserved 4: Reserved 5: Communication setup	0	<input type="radio"/>
--------	-------------------------------	--	---	-----------------------

Vector torque control, torque command can be set by function code P03.13, can also be set by analog, HS pulse input, communication given. 1~4 full scale 100% relative to P03.13.

P03.13	Keypad Setting Torque	-300.0%~300.0% (rated motor current)	100.0%	<input type="radio"/>
P03.14	Torque Setting Filter Time	0.000s~10.000s	0.100s	<input type="radio"/>

Keypad set torque: inverter output torque is directly set by keypad input. 100% relative to motor torque of its rate current.

Torque set the filter time: used to set torque setting changing rate, the bigger the more slower, better for torque stability, but the motor response speed can be slow down.

P03.15	Source Setting of Frequency Upper Limit of Forward in Torque Control	0: Function code P03.17 1: AI1 (100% relate to max output frequency) 2: Reserve 3: Reserve 4: Reserve 5: Communication setting	0	<input type="radio"/>
P03.16	Source Setting of Frequency Upper Limit of Reverse in Torque Control	0: Function code P03.18 1: AI1 (100% relate to max output frequency) 2: Reserve 3: Reserve 4: Reserve 5: Communication setting	0	<input type="radio"/>

Used to select torque control mode forward, reverse frequency upper limit setting source.

P03.17	Frequency Upper Limit Keypad Setting of Forward in Torque Control	0.00Hz~P00.07	50.00Hz	<input type="radio"/>
--------	---	---------------	---------	-----------------------

P03.18	Frequency Upper Limit Keypad setting of Reverse in Torque Control	0.00Hz~P00.07	50.00Hz	<input type="radio"/>
--------	---	---------------	---------	-----------------------

When under torque control mode, forward/reverse upper limit frequency is set by keypad, the above two function code separately relative to forward, reverse upper limit frequency set value.

P03.19	Electric Torque Upper Limit Source Setting	0: Function code P03.21 1: AI1 (100% relate to 3 times of motor current) 2: Reserved 3: Reserved 4: Reserved 5: Communication setting	0	<input type="radio"/>
P03.20	Braking Torque Upper Limit Source Setting	0: Function code P03.22 1: AI1 (100% relate to 3 times of motor current) 2: Reserved 3: Reserved 4: Reserved 5: Communication setting	0	<input type="radio"/>

Used to select motor, brake torque upper limit setting source.

P03.21	Electric Torque Upper Limit Keypad Setting	0.0%~300.0% (rated motor current)	180.0%	<input type="radio"/>
P03.22	Braking Torque Upper Limit Keypad Setting	0.0%~300.0% (rated motor current)	180.0%	<input type="radio"/>

When motor/brake torque upper limit is set by keypad, the two function code is separately relative to motor/brake torque set upper limit.

P03.23	Max Voltage Limit	0.0%~120.0%	100.0%	<input checked="" type="radio"/>
--------	-------------------	-------------	--------	----------------------------------

Used to set inverter max output voltage.

P03.24	Pre-excitation Time	0.000s~10.000s	0.300s	<input type="radio"/>
--------	---------------------	----------------	--------	-----------------------

Pre-excitation time: magnetic flux is build up before motor started, in order to make motor start quick response. If there is run command, the function code will enter to pre-excitation state according to set time, once magnetic flux has built up, then enter to normal Acceleration run.

P03.25	Weak Magnetic Coefficient in Constant Work Area	0.1~2.0	0.3	<input type="radio"/>
P03.26	Min Weak Magnetic Point in Constant Work Area	10%~100%	20%	<input type="radio"/>

In vector control mode, when motor run speed is higher than rate RPM, motor enter to weak flux run stator. Via setting weak flux factor can change weak flux curve, the value is bigger the flux curve is more steep, vice versa, the flux curve getting more flat. As below diagram:

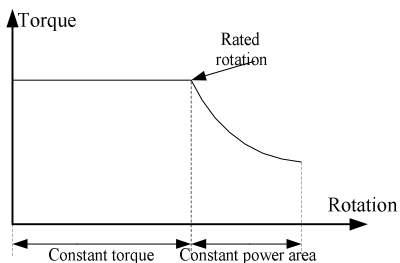

Fig 6.4-3 Weak magnetic function diagram

P03.27	Vector Control Weak Magnetic Proportion Gain	0~4000	1200	<input type="radio"/>
--------	--	--------	------	-----------------------

In vector control mode, when motor RPM is higher than rate RPM, this parameter is used to adjust current response speed.

P03.28	Low Speed Torque Compensation Coefficient	0.0%~50.0%	0.0%	<input type="radio"/>
P03.29	High Speed Torque Compensation Coefficient	0.0%~50.0%	0.0%	<input type="radio"/>
P03.30	Low Frequency Torque Compensation Cutoff Frequency	0.00Hz~50.00Hz	5.00Hz	<input type="radio"/>

P03.31	High Frequency Torque Compensation Cutoff Frequency	0.00Hz~100.00Hz	50.00Hz	○
--------	---	-----------------	---------	---

Above 4 parameter are under torque control mode, separately used to set low frequency compensation factor and low frequency compensation cutoff frequency, high frequency compensation factor and high frequency compensation cutoff frequency. When inverter output frequency lower than P03.30, torque compensation is P03.28 setting coefficient; when inverter output frequency is higher than P03.31, torque compensation is P03.29 setting coefficient; when inverter output frequency is between P0.30~P03.31, torque compensation is P03.28 and P03.29 linear interpolation coefficient.

P03.35	Torque Control Stator Resistance Compensation Selection	0: Disabled 1: Enabled	0	○
--------	---	---------------------------	---	---

By compensating the stator resistance, the low frequency torque is more stable.

6.5 P04 Motor 1 V/F Control Parameters Group

P04.00	Motor V/F Curve Setting	0: Straight line V/F curve 1: Multi-stage V/F curve 2: 1.3#power low torque V/F curve 3: 1.7#power low torque V/F curve 4: 2.0#power low torque V/F curve 5: V/F complete separation 6: V/F half separation	0	⊙
--------	-------------------------	---	---	---

If P00.00 set as 0(V/F control mode), then V/F type is set by P04.00. User can select appropriate V/F curve type according to loading type. If loading is wind pump water pump etc., generally select square V/F curve, 2.0 # power. As below diagram:

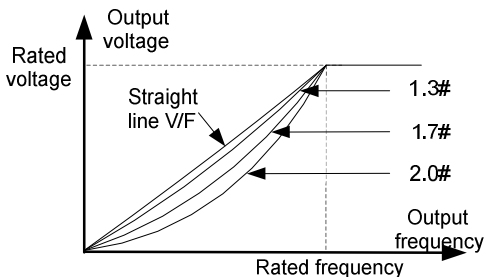

Fig 6.5-1 Schematic Diagram for Parabolic type

P04.02	Motor V/F Frequency Point 1	0.00Hz~P04.04	0.00Hz	○
P04.03	Motor V/F Voltage Point 1	0.0%~110.0% (rated motor voltage)	0.0%	○
P04.04	Motor V/F Frequency Point 2	P04.02~ P04.06	0.00Hz	○
P04.05	Motor V/F Voltage Point2	0.0%~110.0% (rated motor voltage)	0.0%	○
P04.06	Motor V/F Frequency Point 3	P04.04~ P00.07	0.00Hz	○
P04.07	Motor V/F Voltage Point 3	0.0%~110.0% (rated motor voltage)	0.0%	○

When P04.00 set as 1(MS V/F), each stage frequency and voltage can be set by above function code, details as below diagram. The 1st point is 0.00Hz, output voltage is manual torque boost (P04.09) corresponding voltage. The 5th point is rate frequency, output voltage is rate voltage. Other voltage is formed by 5points linear interpolation. MS V/F is used in special application which users has output voltage requirement, or be used in solving some frequency point with resonance phenomena.

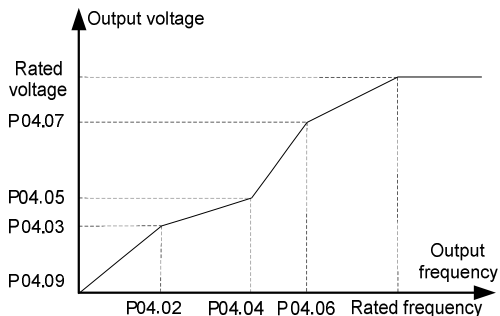

Fig 6.5-2 Schematic Diagram for MS V/F Curve

P04.08	Motor V/F Slip Compensation Gain	0.0%~200.0%	100.0%	○
--------	----------------------------------	-------------	--------	---

Slip compensation gain: used in V/F control mode compensation when loading changes caused motor RPM changes, to improve motor mechanic feature hardness.

The parameter is used in calculating slip frequency, set value 100% stand for rate torque current corresponding with rate slip frequency, so reasonable slip compensation gain system can precisely adjust speed control offset. The parameter set principle: when motor with heavy loading and speed getting lower, it needs to increase the coefficient, otherwise to reduce the factor.

P04.09	Motor V/F Slip Compensation Gain	0.0%~200.0%	0.0%	○
P04.10	Motor V/F Slip Compensation Gain	0.0%~200.0%	20.0%	○

When motor is run under V/F control mode, in order to make up motor stator resistance voltage loss, it needs to compensate certain voltage value, can be set by P04.09, referring to below diagram. Compensation 100.0% is equal to motor rate voltage, generally could not exceeding 10.0%.

The heavy the load, the bigger the boosting, but if the set value is too big can result in burning the motor.

Manual torque boost parameter is effective with linear V/F, parabola V/F, MS V/F.

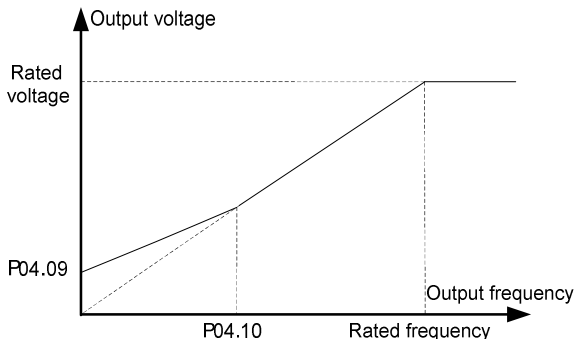

Fig 6.5-3 Schematic Diagram for torque boost

P04.11	Low Frequency Suppression Oscillation Factor of Motor	0~100	10	○
P04.12	High Frequency Suppression Oscillation Factor of Motor	0~100	10	○
P04.13	Suppression Oscillation Cut-off Point of Motor	0.00Hz~P00.07	30.00Hz	○

When motor is under V/F control mode, especially loading motor is big power motor, it can easily cause current oscillation, lightly that motor cannot run steadily, severely that motor can result inverter overcurrent error. At the moment it can properly set this group parameter to eliminate such problem.

P04.14	Motor Voltage Setting Source Selection	0: Function code P04.15 setting 1: AI1 set voltage 2: Reserved 3: Reserved 4: Reserved 5: PID set voltage 6: Communication setting	0	◎
--------	--	--	---	---

When selecting inverter load as V/F separation control (P04.00=5), select output voltage set channel.

P04.15	Motor Keypad Setting Voltage Value	0.0%~100.0%	100.0%	○
--------	--	-------------	--------	---

This parameter is used to set the V/F separation control the output voltage of the keyboard settings.

P04.16	Motor Voltage Increasing Time	0.0s~3600.0s	5.0s	<input type="radio"/>
P04.17	Motor Voltage Decreasing Time	0.0s~3600.0s	5.0s	<input type="radio"/>
P04.18	Motor Maximum Output Voltage	P04.19~100.0% (rated motor voltage)	100.0%	<input checked="" type="radio"/>
P04.19	Motor Minimum Output Voltage	0.0%~ P04.18 (rated motor voltage)	0.0%	<input checked="" type="radio"/>

Used to set the output voltage lower/upper limit in V/F separation control, and the time needed for output voltage increase from 0 to the upper limit or from upper limit decreasing to 0.

P04.20	Motor V/F Control Weak Magnetic Coefficient	1.00~1.30	1.00	<input type="radio"/>
--------	---	-----------	------	-----------------------

In V/F control mode, when motor RPM is higher than rate RPM, motor enter into weak flux run status. Via setting weak flux factor to change its curve, the bigger value it is , the more steeper the curve is, and vice versa, the flux curve getting more flat. Refer to reference function code P03.27

P04.21	Energy Saving Running Selection of Motor	0: Disabled 1: Enabled	0	<input checked="" type="radio"/>
--------	--	---------------------------	---	----------------------------------

This function is used to set the light load motor state, if open the energy saving operation. If open, when the motor in light load condition, the inverter will automatically adjust the output voltage, in order to achieve the goal of energy saving.

6.6 P05 Input Terminals Function Parameter Group

P05.00	Terminal Control Running Mode	0: Two-line mode 1 1: Two-line mode 2 2: Three-line mode 1 3: Three-line mode 2 4: Alternate control 5: Back and forth control	0	⊙
--------	-------------------------------	---	---	---

This parameter defines five different modes of controlling the operation of the inverter via the external terminals

1: Two-line mode 1: This mode is the most commonly used two-line mode. The forward / reverse rotation of the motor is decided by the commands of Dix, Dly terminals; when Dix and Dly are effective, the inverter to keep the first effective terminal determined direction. The terminal function set as below:

Terminal	Set Value	Description
Dix	1	Forward run
Dly	2	Reverse run

Dix、Dly is DI1~DI5、HDI1 Multi function digital input terminals, electric level Enabled.

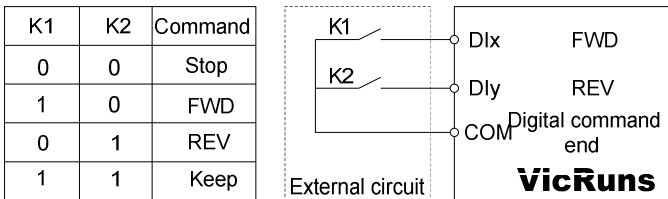

Fig 6.6-1 Schematic diagram of two line mode 1

Two-line run mode 2: When this mode is adopted, Dix is enabled terminal. The direction is determined by the status of Dly. Terminal function set as below.

Terminal	Set Value	Description
Dix	1	Running
Dly	2	(FWD/REV)

Dix、Dly is DI1~DI5、HDI1 Multi function digital input terminals, electric level Enabled.

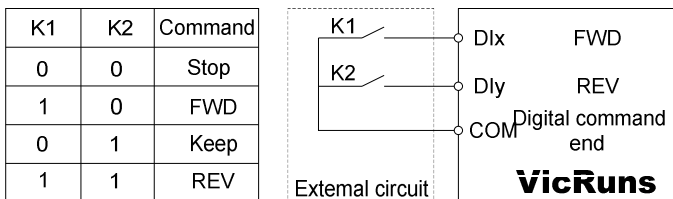

Fig 6.6-2 Schematic diagram of two line mode 2

Three-line control mode 1: In this mode, DIn is enabled terminal, and the direction is controlled by Dlx、Dly respectively. Terminal function set as below.

Terminal	Set Value	Description
Dlx	1	Running
Dly	2	(FWD/REV)
DIn	3	Three-line control mode 1

(1) When need to run, must be closed DIn terminals first, produced by Dlx pulse rising along the motor run signals, Dly status produce motor rotating direction signals.

(2) When need to stop, it should be done by disconnect DIn terminal signal.

(3)The Dlx, Dly, DIn is DI1 ~ DI5, HDI1 multi-function input terminals, Dlx for pulse effectively, Dly, DIn for level effectively;

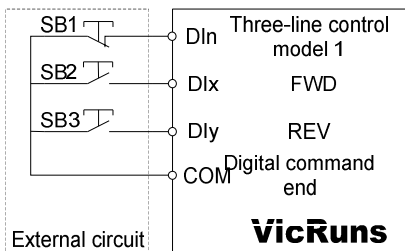

Fig 6.6-3 Three-line control mode 1

SB1: Stop button SB2: Forward rotation button SB3: Forward rotation button

Three-line control mode 2: In this mode, DIn is enabled terminal, and the run command is given by Dlx, while the direction is determined by the status of Dly. Terminal function set as below:

Terminal	Set Value	Description
Dlx	1	Running
Dly	2	(FWD/REV)

DIn	3	Three-line control mode 2
-----	---	---------------------------

(1) When need to run, must be closed DIn terminals first, produced by Dlx pulse rising along the motor run signals, Dly status produce motor rotating direction signals.

(2) When need to stop, it should be done by disconnect DIn terminal signal.

(3)The Dlx, Dly, DIn is DI1 ~ DI5, HDI1 multi-function input terminals, Dlx for pulse effectively, Dly, DIn for level effectively.

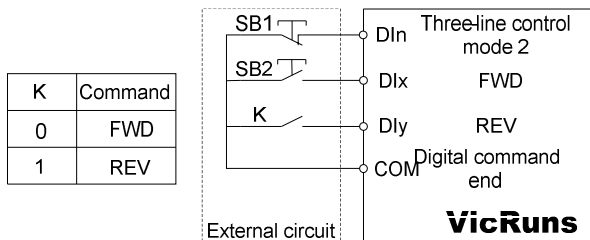

Fig 6.6-4 Three-line control mode 2

SB1: Stop button SB2: Run button K: forward/reverse switchover

Alternative control mode: this mode DIn as enabled terminal, run and the rotating direction and stop are separately controlled by DIn, Dly alternatively. Terminal function as below:

Terminal	Set Value	Description
Dlx	1	Forward, stop
Dly	2	Reverse, stop
DIn	3	Alternative control mode

DIn terminal must be closed before operating, the initial pulse rising by DI x Dly to control motor forward or reverse rotating. The second pulse rising to control stop, and such repeat operation to control inverter start/ stop. Note: Dlx or Dly as start signal and meanwhile as direction signal, if as stop signal then the effect is the same. As for the first time after the electricity through Dlx terminal to make it produce a pulse let inverter is run, the need to stop when the second pulse can be produced by Dlx delay can also be produced by the Dly, the third pulse will delay let inverter is up and run, run direction by a third impulse signal is produced Dlx or pulse produced by Dly.

At the same time, through disconnect DIn terminal signal can also achieve the downtime control frequency converter.

Among them, the Dlx, Dly, DIn is DI1 ~ DI5, HDI1 multi-function digital quantity input terminals, Dlx, Dly for pulse effectively, the DIn of level effectively.

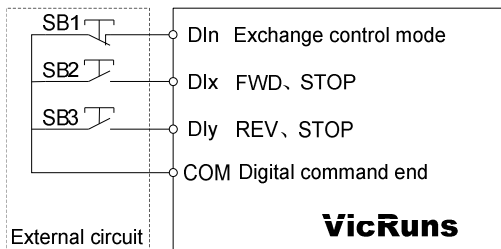

Fig 6.6-5 Alternate control mode

SB1: Stop button、SB2: FWD、STOP button、SB3: REV、Stop button

Back and forth control mode: Din is encode terminal, Dix, Dly is reverse control terminal. Terminal function as below:

Terminal	Set Value	Description
Dix	1	Forward, stop
Dly	2	Reverse, stop
DIn	3	Back and forth control mode

Din terminal must be closed before operating, then motor will run according to the previous memories direction(initial running default forward), when receiving the Dix or Dly pulse rising single, the motor will reverse running relative to before running direction, interval time more than the time set by P05.63, receive the Dix or Dly pulse rising single again, the motor will reverse again, and that cycle repeats.

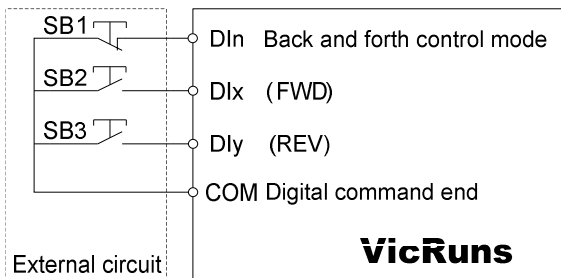

Fig 6.6-6 Back and forth control mode

P05.01	D11 Input Terminal Function Selection	0~63, see table blow	1	⊙
--------	---------------------------------------	----------------------	---	---

P05.02	DI2 Input Terminal Function Selection		2	⊙
P05.03	DI3 Input Terminal Function Selection		4	⊙
P05.04	DI4 Input Terminal Function Selection		6	⊙
P05.05	HD11 Input Terminal Function Selection		8	⊙

This parameter is used to set the functions of the multifunctional digital input terminals.

Set Value	Function	Description
0	No function	The terminals not being used can be set "no function", to avoid wrong operation.
1	Forward running	Via external terminals to control inverter forward reverse run.
2	Reverse running	
3	Three-line run control	Via this terminal to confirm the inverter run mode is 3 line run or alternative control mode. Refer to function code P05.00 ("terminal control run mode") description.
4	Forward Jog(FJOG)	FJOG is jog forward run, RJOG is jog reverse run. Jog run frequency, jog Acceleration/down time refer to function code P09.00, P09.01, P09.02 description.
5	Reverse Jog(RJOG)	In any control mode (panel control, terminal control, communication control), inverter block output, at present motor stop is not controlled by inverter. This method is the same as P01.05 described random stop.
6	Coast to stop	Inverter Deceleration stop, all run parameter is in memory status; run is paused or stopped without receiving start signal, electric level effective.
7	Run pause	Inverter Deceleration stop, but all run parameter is in memory state, while run it doesn't accept start/stop signal, electric level effective.
8	Fault reset (RESET)	Using terminal function to reset error, the same function as keypad RESET. This function can

		realize long distance error reset.
9	External fault input	When external error signal pulse sent to inverter, inverter alarm error Er017.
10	Frequency setting increase(UP)	By external terminal pre-set frequency to change frequency up/down command. Setting frequency can be goes up/down.
11	Frequency setting decrease(DOWN)	When frequency preset is digital preset or analog preset, the terminal jog can clear terminal UP/DOWN or keypad UP/DOWN to change frequency, to make frequency preset frequency recovering to initial value, pulse effective.
12	Frequency UP/DOWN setting clear	When frequency to a digital or analog given to the timing, the terminal point move can remove terminal keyboard UP/DOWN or UP/DOWN frequency values change by the given frequency back to the initial value, pulse effectively.
13	Frequency UP/DOWN setting clear temporary	When frequency to a digital or analog given to the timing, the terminal can remove temporarily closed terminal keyboard UP/DOWN or UP/DOWN frequency values change by the given frequency back to the initial value, terminal disconnect after return to terminal keyboard UP/DOWN or UP/DOWN frequency values change by level effectively.
14	Acceleration/deceleration time selection 1	It can select four types of Acceleration/Deceleration time through the combination of digital status of these two terminals. Refer to attached table 2 for detail.
15	Acceleration/deceleration time selection 1	
16	MS speed terminal 1	It can realize 16S speed through the combination of digital status of these four terminals. Refer attached table 1 for the 16 MS speed function and other 16 commands.
17	MS speed terminal 2	
18	MS speed terminal 3	
19	MS speed terminal 4	
20	MS speed pause	When the terminal is effective, MS speed function is Disabled temporarily and return to the original frequency temporarily; When the terminal failure, the inverter recover to MS speed run state.
21	Immediate DC braking	This terminal is enabled, and the inverter directly switchover to the DC brake status

22	Deceleration DC braking	The terminal is Enabled, slow down to stop inverter and DC braking starting frequency, and then switchover to DC braking state;
23	External stop	In any control mode, the terminal is used to make frequency converter and Deceleration and stop or free stop, stop method by function code P01.05 setting determines;
24	Emergency stop function	The terminal is Enabled, inverter stop at the fastest speed
25	PID control pause	PID temporarily adjusting
26	Reverse PID action direction	The terminal is Enabled, PID action direction and the reverse direction set by P08.04 set
27	PID parameter switchover	To switchover PID parameter
28	Pre-excitation command	The terminal (level) is effective, the inverter excitation of effective is Enabled until the terminal is Disabled;
29	Reserved	
30	Acceleration/deceleration disabled	Protect the inverter from affecting by the external signals (except emergency stop command), and maintain the current output frequency
31	Switchover between Set A and set B	When the command source is Enabled, the inverter frequency source can be switchover in various frequency source or frequency source combination.
32	Switchover between Combined set and set A	
33	Switchover between Combined set and set Br	
34	Simple PLC stop reset	In stop state, when the terminal (pulse) effectively, the inverter recover to initial status of reserved
35	Simple PLC pause	Inverter in the executive summary of reserved operation process, when the terminal effective (level), simple reserved to suspend operation, when the terminal failure, the inverter easy to recover from a pause state of reserved operation.
36	Counter trigger	The input terminal of counter
37	Counter reset	Clear up the counter status.

38	Length trigger (reserve)	Input terminal of length counter
39	Length reset (reserve)	Length counter clear up
40	Command switchover to keypad	When the terminal effective (level), switchover the inverter command source to the corresponding command source.
41	Command switchover to terminal	
42	Command switchover to communication	
43	Power consumption clear	Clear up the power consumption counter (pulse effective)
44	Power consumption holding	Keep the power consumption counter, but the inverter present run of power consumption is not accumulated (electric level effective)
45	Swing frequency pause(stop at present frequency)	The inverter keep present output frequency. Swing frequency function paused.
46	Swing frequency reset(back to center frequency)	Inverter keep the central frequency output, Swing frequency function Enabled
48	Motor switchover	When this terminal effective, the inverter counting time of present run is cleared, the function and present run arrival time (P09.32) can be cooperatively used.
49	Clear the current running time	When user defined external error normally closed signal is sent to inverter, inverter alarm, error will be disposed according to alarm protection action mode.

Attached Table 1 MS Speed Function Description

K4	K3	K2	K1	Direct setting	Corresponding Parameter
OFF	OFF	OFF	OFF	MS speed 0	P11.00
OFF	OFF	OFF	ON	MS speed 1	P11.01
OFF	OFF	ON	OFF	MS speed 2	P11.02
OFF	OFF	ON	ON	MS speed 3	P11.03
OFF	ON	OFF	OFF	MS speed 4	P11.04

OFF	ON	OFF	ON	MS speed 5	P11.05
OFF	ON	ON	OFF	MS speed 6	P11.06
OFF	ON	ON	ON	MS speed 7	P11.07
ON	OFF	OFF	OFF	MS speed 8	P11.08
ON	OFF	OFF	ON	MS speed 9	P11.09
ON	OFF	ON	OFF	MS speed 10	P11.01
ON	OFF	ON	ON	MS speed 11	P11.11
ON	ON	OFF	OFF	MS speed 12	P11.12
ON	ON	OFF	ON	MS speed 13	P11.13
ON	ON	ON	OFF	MS speed 14	P11.14
ON	ON	ON	ON	MS speed 15	P11.15

4 MS speed command terminals can be combined into 16 kinds of status, which corresponding to 16 command setup value, as shown in table 1. Multistage speed instruction except as a multistage speed function, also can be a given source of PID, in order to meet the different demand of various setup value.

When frequency source is choosing as multi-stage speed, function code P11.00 ~ P11.15 100.0% corresponding with max output frequency P00.07.

When MS command source as PID given source, function code P11.00~P11.15 100.0% corresponding with PID feedback range 100%, the full range of feedback meter.



WARNING

- In all frequency command source, the MS speed command priority is highest, when multistage speed arbitrary terminals function is effective, multistage speed command is in priority.

Attached Table 2 acceleration/deceleration time selecting terminal function description

Terminals 1	Terminals 2	Acceleration/Deceleration time selection	Corresponding Parameter
OFF	OFF	Acceleration/Deceleration 0	P00.14、P00.15
OFF	ON	Acceleration/Deceleration 1	P09.03、P09.04
ON	OFF	Acceleration/Deceleration 2	P09.05、P09.06
ON	ON	Acceleration/Deceleration 3	P09.07、P09.08

P05.10	HDI1 Terminal Function Selection	0: HS pulse input 1: Switch signal input	0	<input checked="" type="radio"/>
--------	----------------------------------	---	---	----------------------------------

Set HDI1 terminal input property setup, default is HS pulse input function.

P05.11	Input Terminal Polarity Selection	0x00~0x1F	0x00	<input checked="" type="radio"/>
--------	-----------------------------------	-----------	------	----------------------------------

Set DI digital input terminal effective state mode

0: When selecting switchover close effective, corresponding DI terminal connected with COM or OPEN is effective, open is invalid;

1: When selecting switchover open effective, corresponding DI terminal connected with COM or OPEN is invalid, open is effective;

P05.12	Digital Input Filter Time	Digital Input Filter Time	0.010s	<input type="radio"/>
--------	---------------------------	---------------------------	--------	-----------------------

It is used to set the software filter time of DI terminal status. If input terminal is easily interfered or resulting in wrong action in some application, in order to increase anti-interference capacity, the parameter can be increased. But the DI terminal responding getting slow if filter time increased (HDI1 input function is Disabled in HD pulse input)

P05.18	AI1 Input Type Selection	0: Voltage input 1: Current input	0	<input type="radio"/>
P05.19	Lower Limit of AI1 Voltage	-10.00V~P05.21	0.00V	<input type="radio"/>
P05.20	Corresponding Setting of AI1 Voltage Lower Limit	-100.0%~100.0%	0.0%	<input type="radio"/>
P05.21	Upper Limit of AI1 Voltage	P05.19~10.00V	10.00V	<input type="radio"/>
P05.22	Corresponding Setting of AI1 Voltage Upper Limit	-100.0%~100.0%	100.0%	<input type="radio"/>
P05.23	Lower Limit of AI1 Current	-20.00mA~P05.25	0.00mA	<input type="radio"/>
P05.24	Corresponding Setting of AI1 Current Lower Limit	-100.0%~100.0%	0.0%	<input type="radio"/>

P05.25	Upper Limit of AI1 Current	P05.23~20.00mA	20.00mA	○
P05.26	Corresponding Setting of AI1 Current Upper Limit	-100.0%~100.0%	100.0%	○
P05.27	AI1 Input Filter Time	0.000s~10.000s	0.100s	○

Above function code is used to set the relation of analog AI1 input voltage and its standing setting value.

When analog input voltage is bigger or smaller than set upper limit (P05.21) or lower limit (P05.19), take the upper limit(P05.21) or lower limit (P05.19) to calculate.

AI1 input filter time, used to set AI1 software filter time, when the on-site analog is easily effected, then increase filter time to make detecting analog signal getting steady. But the filter time is bigger, the analog signal detecting response speed is lower. Please consider the actual situation to set.

In different application, analog set 100.0% is different from its corresponding nominal value, please refer to application description. Below diagram is two typical setting situation:

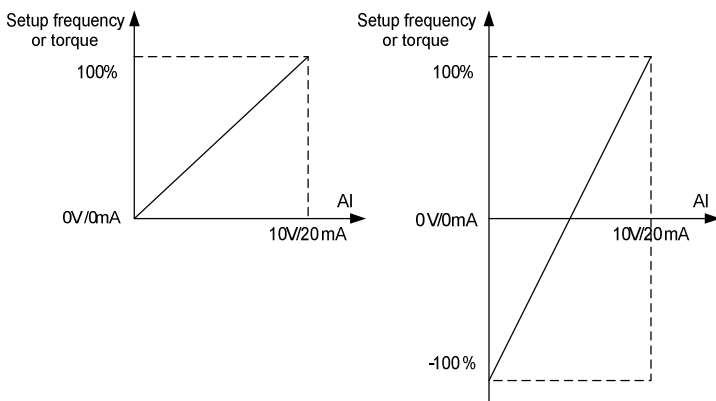

Fig.6.6-7 Corresponding Relationship between Analog Reference and Setting

P05.39	Minimum Frequency of High-speed Pulse Input HDI1	0.00kHz~P05.41	0.00kHz	○
--------	--	----------------	---------	---

P05.40	Corresponding Setting of Minimum Frequency of High-Speed Pulse Input HDI1	-100.0%~100.0%	0.0%	○
P05.41	Maximum Frequency of High-Speed Pulse Input HDI 1	P05.39~100.00kHz	50.00kHz	○
P05.42	Corresponding Setting of Maximum Frequency of High-Speed Pulse Input HDI1	-100.0%~100.0%	100.0%	○
P05.43	HS (Pulse) Input HDI1 Filter Time	0.000s~10.000s	0.100s	○

The set of function is used to set the relation of HDI1 pulse frequency and corresponding setup. Pulse frequency only input by HDI1 channel to inverter. The set function is similar to AI1, refer to AI1 description.

P05.44	D1 Terminal Close Delay Time	0.000s~60.000s	0.000s	○
P05.45	D1 Terminal Disconnect Delay Time	0.000s~60.000s	0.000s	○
P05.46	D12 Terminal Close Delay Time	0.000s~60.000s	0.000s	○
P05.47	D12 Terminal Open Delay Time	0.000s~60.000s	0.000s	○
P05.48	D13 Terminal Close Delay Time	0.000s~60.000s	0.000s	○
P05.49	D13 Terminal Open Delay Time	0.000s~60.000s	0.000s	○
P05.50	D14 Terminal Close Delay Time	0.000s~60.000s	0.000s	○
P05.51	D14 Terminal Open Delay Time	0.000s~60.000s	0.000s	○
P05.52	HDI1 Terminals Close Delay Time	0.000s~60.000s	0.000s	○

P05.53	HDI1 Terminals Open Delay Time	0.000s~60.000s	0.000s	<input type="radio"/>
--------	-----------------------------------	----------------	--------	-----------------------

The group function code is used to set the delay time of inverter disposing input signal when the input terminal connecting and disconnecting. HDI1 channel input function is Enabled only when switchover input function namely P05.10 = 1 delay effective. As following figure:

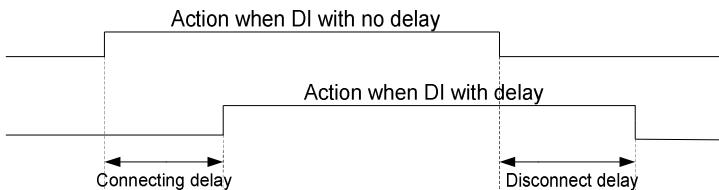

Fig.6.7-7 DI connection delay and disconnection delay diagram

P05.62	Virtual Input Terminal Setting Selection	0: Disabled 1: Communication setting	0	<input type="radio"/>
--------	--	---	---	-----------------------

This function code is used to set the input terminals in the communication control, whether or not to use communication virtual terminal to control converter. Please refer to the communication protocol in detail. Note: when the input terminals use communication control, can only use all communication virtual terminal control mode.

P05.63	Travel Switch Lock Time	0.0s~60.0s	1.0s	<input type="radio"/>
--------	----------------------------	------------	------	-----------------------

For terminal control operation mode 5 (Round trip control), please refer to the detail specification of round trip control mode.

6.7 P06 Output Terminal Function Parameter Group

P06.00	HDO1 Terminals Function Selection	0: HS Pulse output (Optional) 1: Switch signal output	1	<input type="radio"/>
--------	-----------------------------------	--	---	-----------------------

HDO1 terminal is programmable multiplexing terminal. It can be used as high-speed pulse output (HDO), It can also be used as collector open circuit output terminal (DO).

P06.02	Output Terminal Polarity Selection	0x00~0x05	0x00	<input type="radio"/>
--------	------------------------------------	-----------	------	-----------------------

Define output side digital output logic.

0: Switchover closed, digital output terminal and corresponding mutual terminal connected is Enabled status, disconnected is Disabled status.

1: Switchover opened, digital output terminal and corresponding mutual terminal connected is Disabled status, disconnected is Disabled status.

P06.03	HDO1 Output Terminal Function Selection	0~32, see table blow	0	<input type="radio"/>
P06.05	Relay T Output Function Selection		0	<input type="radio"/>

Digit output terminal function table:

Set Value	Function	Description
0	Disabled	There have no function on output terminals
1	Inverter in running	It indicate the inverter is in running state, have the output frequency(can be zero), the output ON signal.
2	Forward running	It indicate the inverter is in forward running state, there have output frequency, output ON signal at this time.
3	Reverse running	It indicate the inverter is in reverser running state, there have output frequency, output ON signal at this time.
4	JOG running	It indicate the inverter is in jog running state, output ON signal at this time.
5	Inverter fault	When the inverter fails and downtime, output ON signal.
6	Pre excitation	When the inverter in excitation, output ON signal.
7	Frequency inverter	When the main circuit and control circuit of supply is stable, and the inverter not detected any failure

	ready running	information, the inverter in the running, output ON signal.
8	Overload pre-warning	Before overload protection, according to the overload forecasting warning threshold value to judge, after more than forecasting warning threshold output ON signal. Parameter set refer to the function code P13.04, P13.05, P13.08.
9	Off load pre-warning	Before offload protection, according to the overload forecasting warning threshold value to judge, after more than forecasting warning threshold output ON signal. Parameter set refer to the function code P13.06, P13.07, P13.08.
10	Frequency level detection FDT1 output	Please refer to the function code P09.10, P09.11 specification
11	Frequency level detection FDT2 output	Please refer to the function code P09.12, P09.13 specification
12	Zero speed running 1 (have no output when stop)	When frequency inverter is running and the output frequency is 0, the output ON signal. When inverter is in a state of downtime, the signal is OFF.
13	Frequency reached	When the output frequency of inverter into the set frequency detection range, output ON signal, see the function code P0.09.
14	Frequency upper limit reached	When operation frequency reach to the upper limit frequency, output ON signal.
15	Frequency lower limit reached	When operation frequency reach to the lower limit frequency, output ON signal. When inverter is in a state of downtime, the signal is OFF.
16	Set count value reached	When the count reach to the set value of P09.27, the output ON signal. Counting function reference function group P09.
17	Designated count value reached	When the count reach to the set value of P09.28, the output ON signal.
18	Reserved	
19	Reserved	
20	Reserved	
21	Accumulative running time reached	When frequency inverter in the total run time more than the setting time of P09.30, output ON signal.

22	Accumulative power-on time reached	When frequency inverter in the total on power time more than the setting time of P09.31, output ON signal.
23	Current running time reached	When frequency inverter run time more than the setting time of P09.32, output ON signal.
24	Current power-on time reached	When frequency inverter on power time more than the setting time of P09.33 output ON signal.
25	Any frequency reached	When the output frequency of inverter into the detection range of set arbitrary frequency, output ON signal. See the function code P09.34, P09.35.
26	Any current reached	When the output frequency of inverter into the detection range of set arbitrary frequency, output ON signal. See the function code P09.36, P09.37.
27	Current limit exceeded	The output current of inverter exceed the set current. See the function code P013.09~P13.11.
28	Communication virtual terminal output	The DO output terminals of frequency converter is controlled by communication. Please refer to the communication protocol.
29	Reserved	
30	Communication virtual terminal output	When the inverter is in a state of downtime and output ON signal or frequency converter in the run immediately when receives the stop command output ON signal.
31	Run (non-jog run)	When inverter is in jog running, output ON signal.
32	Length reached	When length counting reach to set length, output ON signal. See the function code P09.25, P09.26.

P06.08	AO1 Analog Output Selection	0~17, see table below	0	○
P06.09	AO2 Output Selection			
P06.10	HDO1 Pulse Output Functions			

Analog output AO1 and AO2 output range is 0V~10V or 0/4mA~20mA. HDO1 terminal output pulse frequency range is 0.01kHz~P06.01(the output max frequency of HDO1 pulse output mode), P06.01 can be set from 0.01kHz~100.00kHz.

Pulse or analog signal output 0.0%~100.0% corresponding function as below table:

Set value	Function	Description
0	Running frequency	100.0% Corresponding the maximum output frequency
1	Set frequency	100.0% Corresponding the maximum output frequency
2	Output current 1	100.0% Corresponding 2 times of rated motor current
3	Output voltage1	100.0% Corresponding 1.5 times of rated inverter voltage
4	Motor rotational speed	100.0% Corresponding 2 times of rated motor speed
5	Output power	100.0% Corresponding 2 times of rated motor power
6	High speed pulse HDI input value	100% corresponding HDO1 output upper limit
7	AI1 input value	0.00V~10.00V
8	Reserved	
9	Reserved	
10	Reserved	
11	Count value	0~Max count value
12	Output torque	100.0% corresponding 2 times of motor rated torque
13	Output current 2	0.0A~1000.0A
14	Output voltage 2	0.0V~1000.0V
15	Slope set frequency	100.0% corresponding max output frequency
16	Communication set value 1	Corresponding MODBUS communication set value 1
17	Communication set value 2	Corresponding MODBUS communication set value 2

P06.11	AO1 Output Voltage Lower Limit	0.00V~P06.13	0.00V	○
P06.12	Corresponding Setting Value of AO1 Voltage Output Lower Limit	0.0%~100.0%	0.0%	○
P06.13	AO1 Output Voltage Upper Limit	P06.11~10.00V	10.00V	○
P06.14	Corresponding Setting Value of AO1 Output Voltage Upper Limit	0.0%~100.0%	100.0%	○
P06.15	AO1 Output Filter Time	0.000s~10.000s	0.000s	○

The function code used to set the relation of analog output voltage and its representing set value.

When AO1 output is the current output, 1mA current is equal to 0.5V voltage, so 20mA current equal to 10V.

When AO1 output is current output, it is suggested to add external resistor with less than 500Ω

P06.21	HDO1 Output Voltage (Current) Lower Limit	0.0%~P06.23	0.0%	○
P06.22	Lower Limit Corresponding HDO1 Output	0.00kHz~100.00kHz	0.0kHz	○
P06.23	HDO1 Output Upper Limit	P06.21~100.0%	100.0%	○
P06.24	Upper Limit Corresponding HDO1 Output	0.00kHz~100.00kHz	50.00kHz	○

When selecting HDO1 terminals as pulse output, the function code is used to set value between the high-speed pulse output and its representative set value.

P06.25	HDO1 Output Filter Time	0.000s~10.000s	0.000s	○
--------	-------------------------	----------------	--------	---

P06.26	DO1 Terminals Closed Delay	0.0s~60.000s	0.000s	○
P06.27	DO1 Terminals Open Delay	0.0s~60.000s	0.000s	○
P06.30	HDO1 Terminals Close Delay	0.0s~60.000s	0.000s	○
P06.31	HDO2 Terminals Open Delay	0.0s~60.000s	0.000s	○

Set output terminal DO1, HDO1, Relay T1, Relay T2 delay time from status change to actual output change. As below diagram:

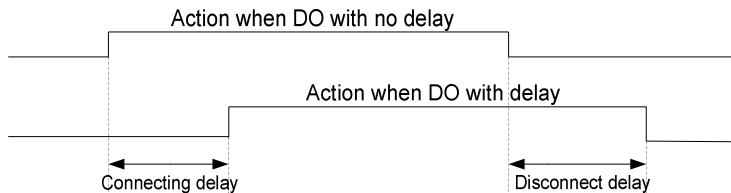

Fig. 6.7-1 DO connected delay and open delay diagram

6.8 P07 AIAO Correction Group

P07-00	AI1 Measured Voltage 1	0.500V~4.000V	Factory Correction	<input type="radio"/>
P07-01	AI1 Displayed Voltage 1	0.500V~4.000V	Factory Correction	<input type="radio"/>
P07-02	AI1 Measured Voltage 2	6.000V~9.999V	Factory Correction	<input type="radio"/>
P07-03	AI1 Displayed Voltage 2	6.000V~9.999V	Factory Correction	<input type="radio"/>

This group of function code, used to correction analog input of AI, to eliminate the influence input port zero bias and gain of AI.

This group of function parameters has been calibrated before delivery, will revert to the factory values after correction when factory reset. Generally don't to correction at the scene of the application.

Measured voltage, by measuring instruments such as multi meter measure out the actual voltage. Display voltage, means the sampling voltage display values by frequency inverter, refer to the voltage display before AI correction of Group P28 (P28.16).

When correction, input two voltage values in each input port of AI, and input the value measured from multi meter and read value by group P28 to function code accurately, the frequency inverter will correction the zero bias and gain of AI automatically.

P07-12	AO1 Target Voltage 1	0.500V~4.000V	Factory Correction	<input type="radio"/>
P07-13	AO1 Measured Voltage 1	0.500V~4.000V	Factory Correction	<input type="radio"/>
P07-14	AO1 Target Voltage 2	6.000V~9.999V	Factory Correction	<input type="radio"/>
P07-15	AO1 Measured Voltage 2	6.000V~9.999V	Factory Correction	<input type="radio"/>

This group of function code, used to correction analog output of AO.

This group of function parameters has been calibrated before delivery, will revert to the factory values after correction when factory reset. Generally don't to correction at the scene of the application.

Target voltage means the theory of inverter output voltage value. Measured voltage, by measuring instruments such as multi-meter measure out the actual voltage.

6.9 P08 Process PID Control Parameter Function

Process PID close loop control is adopting proportion(P), integration(I), Differential(D) 3 part composed regulator in control system, a control method to make feedback value and command value deviation to gradually decrease. It is applicable in flow, pressure, temperature etc. process control.

Proportional control (P): a control quantity in proportion with deviation

Integration Control (I): a control quantity in proportion with deviation integral value

Differential control (D): a control quantity in proportion with deviation change ratio, can forecast deviation change tendency, quick response to violate changes, improve dynamic performance. But is easily to introduce and amplify interference signal and resulting system unsteady, please consider carefully.

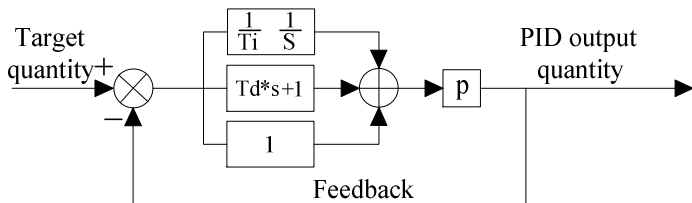

Fig 6.8-1 PID Control Principle Framework

P08.00	PID Command Source	0: Function code P08.01 1: AI1 2: AI2 3: AI3(extension card) 4: HS pulse input 5: MS speed command 6: Communication setting 7: Keypad potentiometer	0	○
--------	--------------------	--	---	---

Set PID command source, when selecting manufacturer default 0, it is using keypad set PID target given value. The setup target value of the process PID is relative value, and the setup 100% is relative to full range of feedback signal of the controlled system. The system will always calculate according to the relative value (0 to 100%).

Note: When command source selecting PID output (P00.02 or P00.03 set as 8) then process PID control is effective.

P08.01	PID Command Set Value	0.0%~100.0%	50.0%	○
--------	-----------------------	-------------	-------	---

When PID command source selecting function code P08.01 setup, PID control command value is the set value of its function code.

P08.02	PID Command UP/DOWN Time	0.00s~100.00s	0.00s	○
--------	--------------------------	---------------	-------	---

Set PID command UP/DOWN time, the soft start function is to set UP/DOWN time to increase/decrease PID command value in PID control. The set time is the time required from 0.0% command increasing to 100.0% command, or from 100.0% command decreasing to 0.0% command.

P08.03	PID Feedback Source	0: AI1 1: Reserved 2: Reserved 3: Reserved 4: Reserved 5: Reserved 6: Reserved 7: HS Pulse input setting (optional) 8: Communication control	0	○
--------	---------------------	--	---	---

Set feedback source of PID close loop control, feedback input channel must be external input and cannot share the same channel with PID given channel. Otherwise it result PID control Disabled.

P08.04	PID Output Feature Selection	0: PID output is positive feature 1: PID output is negative feature	0	○
--------	------------------------------	--	---	---

PID output positive feature: When PID feedback is smaller than the PID command, deviation is positive, it needs to increase inverter output frequency to balance the PID.
PID output negative feature: When PID feedback is smaller than the PID command, deviation is positive, it needs to reduce inverter output frequency to balance the PID.
The function code and DI function(the reverse of PID action direction) do EO logic as the actual PID action direction.

P08.05	PID Feedback Display Coefficient	0.00~655.35	1.00	○
--------	----------------------------------	-------------	------	---

PID feedback display coefficient: PID command value 100% (feedback meter full range) corresponding physical quantity in PID control system. Such as constant pressure water supply system, the pressure meter full range 30.0MPa, the PID feedback display coefficient set as 30.0, at this stage the status display function code PID setup P28.22, PID feedback P31.18 corresponding value unit is the physical unit of 0.1MPa.

P08.06	Proportional Gain 1	0.0~100.0	1.00	○
P08.07	Integral Time 1	0.00: Disabled integral	0.10	○

		0.01s~10.00s		
P08.08	Differential Time 1	0.00s~10.00s	0.00s	○
P08.09	Proportional Gain 2	0.0~100.0	1.00	○
P08.10	Integral Time 2	0.00: Disabled integral 0.01s~10.00s	0.10	○
P08.11	Differential Time 2	0.00s~10.00s	0.00	○

In order to meet process PID control in complicate control application, the inverter has built-in 2 groups separate PID control parameter.

Proportional gain (Kp): It decides the adjustment intensity of the whole PID regulator. The higher the P is, more powerful the adjustment intensity is. When this parameter is 100, indicating the deviation between PID feedback quantity and the reference quantity is 100%, the adjustment amplitude of the PID regulator on the output frequency command is maximum frequency (the integral and differential functions are neglected).

Integration time (Ti): It decides the PID regulator integration adjusting speed of the deviation which between the PID feedback quantity and the reference quantity. Integration time is the time within which the integration regulator (the proportional and differential functions are neglected) performs continuous adjustment and the adjustment quantity reaches maximum frequency (P00.07) when the deviation between the PID feedback quantity and reference quantity is 100%. The shorter the integration time is, more powerful the adjustment intensity is.

Differential time (Td): It decides the intensity of PID regulator adjusting the change rate of deviation between the PID feedback quantity and the reference quantity. Differential time is the time within which if the feedback quantity changes 100%, the adjustment quantity reaches maximum frequency (P00.07) (proportional and integral functions are neglected). The longer the differential time is, more powerful the adjustment intensity is.

P08.12	PID Parameter Switchover Condition	0: No switch (only use PID parameter 1) 1: DI terminal 2: Auto switch according to deviation	0	○
P08.13	PID Parameter Switchover Deviation 1	0.0%~100.0%	20.0%	○
P08.14	PID Parameter Switchover Deviation 2	0.0%~100.0%	80.0%	○

2 set of independent PID control parameters can be set by P08.12 as not-switchover, DI terminal or automatic-switchover. If you choose to PID parameters automatically switchover, when a given and feedback error absolute value is less than the PID parameters switchover deviation 1 namely P08.13 set value, the PID control

parameters selected PID parameter 1; when a given and feedback error absolute value is bigger than the PID parameters of deviation 2 namely P08.14 set value, the PID control parameters selected PID 2; When a given and feedback error absolute value between PID switchover deviation 1 and PID deviation 2, PID control parameters is linear interpolation of two groups of PID control parameters values. As shown in the figure below:

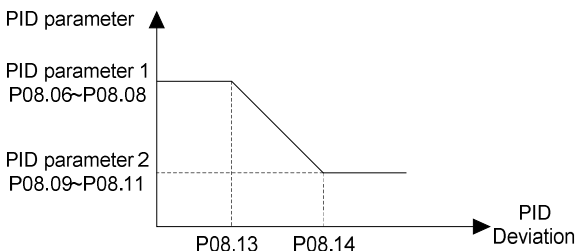

Fig 6.8-2 Schematic diagram for PID parameters automatically switchover

P08.15	PID Deviation Limit	0.0%~100.0%	0.0%	<input type="radio"/>
--------	---------------------	-------------	------	-----------------------

When the deviation of PID command and feedback is smaller than function code set value, PID regulator stop regulation, PID output maintains with no change, for some application it can increase PID regulator stability.

The corresponding relation of Deviation limit and output frequency as below diagram:

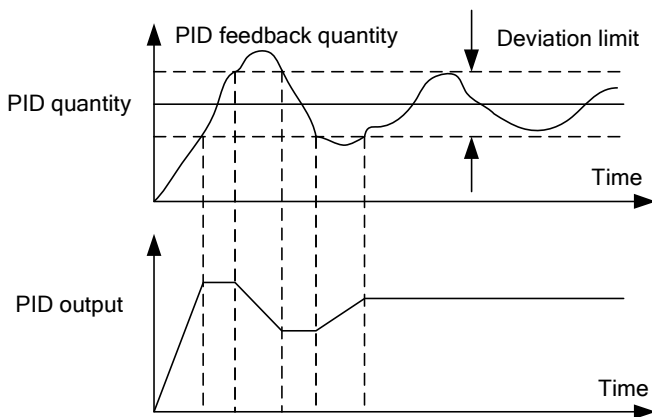

Fig. 6.8-3 PID deviation limit diagram

P08.16	PID Preset Output Mode	0: No preset output mode 1: Output according to holding	0	<input checked="" type="radio"/>
--------	------------------------	--	---	----------------------------------

		time 2: Output when PID feedback < switchover threshold 3: Output when PID feedback > switchover threshold		
P08.17	PID Preset Output Value	0.0%~100.0% (as frequency command relative to max output frequency P00.07)	10.0%	○
P08.18	PID Preset Output Value Holding Time	0.00s~600.00s	0.50s	○
P08.19	PID Preset Output Switchover Threshold	0.0%~100.0%	50.0%	○

When P08.16 set to non-zero, namely enable PID preset mode. Appropriate setting preset frequency, preset holding time of PID preset frequency, or preset output switchover threshold, to avoid the inverter start initial feedback and command deviation limits and make the PID regulator saturation, can make the closed-loop regulating quickly into a stable stage and no obvious overshoot or oscillation.

After the PID run, frequency accelerate to PID preset point according to acceleration/deceleration time, and will keep run at the frequency point until it doesn't meet the PID preset output retention condition as in P08.16 set, then run according to PID regulator output. As below diagram P08.16 set as 1:

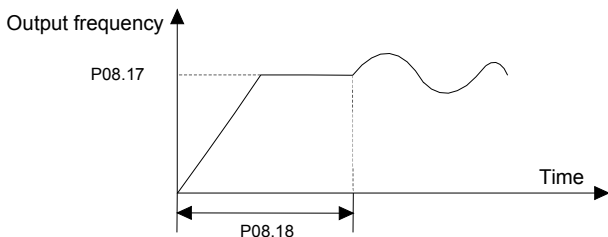

Fig 6.8-4 Schematic diagram if PID preset output

P08.20	Feedback Wire-break Detection Value	0.0%: No detection 0.1%~100.0%	0.0%	○
P08.21	Feedback Wire-break Detection Time	0.0s~20.0s	0.0s	○

If P08.20 set to a non-zero value, when the feedback signal is less than P08.20 set detection value but exceeding P08.21 setting time, it decided the PID feedback break line, system will report the PID feedback break line breakdown (Er023).

P08.22	Feedback Over-limit Detect Value	0.0%: No detection 0.1%~100.0%	0.0%	○
P08.23	Feedback Over-limit Detection Time	0.0s~20.0s	0.0s	○

When the feedback signal is bigger than P08.22 set detection value but exceeding P08.23 setting time, it decided the PID feedback exceeding limit, system will report the PID feedback exceeding limit breakdown (Er022).

P08.24	PID Dormant Threshold	P08.25~100.0% 100.0%: cancel sleep function	100.0%	○
P08.25	PID Wakeup Threshold	0.0%~ P08.24	0.0%	○
P08.26	PID Dormant Waiting Time	0.0s~6000.0s	1.0s	○
P08.27	PID Wakeup Waiting Time	0.0s~6000.0s	0.5s	○

PID dormancy: when the system detects that the PID feedback value is higher than PID dormancy threshold and maintain time exceeding than PID dormant waiting time , inverter will start decelerate according to the time set by the deceleration time, and later enter into a dormant state when frequency drop to zero. If in the above process PID feedback below the PID dormancy threshold, PID return back to regulating state, dormancy wait counting clear up. When this parameter is set to 100%, the PID dormancy function is Disabled.

PID awakening: when inverter is in PID dormant state, once if PID feedback below the PID revive threshold and maintain time exceeding than PID revive waiting time, inverter will exit dormant state and return back to PID regulating mode.

P08.28	PID Calculation Mode	0: Stop with no calculation 1: Stop with calculation	0	○
--------	----------------------	---	---	---

Used to decide whether to continue the PID arithmetic when inverter is in stop status. General applications, in stop state inverter should stop PID calculation. The stop operation selection might be useful in constant pressure water supply system and other special occasions.

P08.29	PID Output Positive Max Value	0.0%~100.0%	100.0%	○
P08.30	PID Output Reverse Max Value	0.0%~100.0%	0.0%	○

PID output positive, negative max value, used to limit PID output modulation.

P08.33	PID Output Positive Maximum Variation	0.0%~100.0%	0.0%	<input type="radio"/>
P08.34	PID Output Reverse Maximum Variation	0.0%~100.0%	0.0%	<input type="radio"/>

Operation of the inverter PID control, the parameter is used to set the variation ratio of PID actual output .

P08.36	PID Adjust Selection	0: Continue integration arriving upper and lower limit 1: Stop integration arriving upper and lower limits	1	<input type="radio"/>
--------	----------------------	---	---	-----------------------

When PID control operation and using integration function to decide whether continue integration when set upper/lower limit arrived.

Reach the upper/lower limit to continue integral: integral quantity has real-time response to the changes between given quantity and feedback quantity, unless the internal integral limit has been reached. When the size of trend between given quantity and feedback quantity changes, it takes longer time to offset continuous integration effect, so integration will follow the changing tendency.

Reach the upper and lower limit to stop integration: the integrating quantity remains with no change, when the size of trend between given quantity and feedback quantity varies, integration will quickly follow the tendency.

P08.37	Lower Limit Frequency of Feedback Break Line Detection	0.00Hz~50.00Hz	0.0%	<input type="radio"/>
--------	--	----------------	------	-----------------------

Set the lower limit of the feedback of PID action, reduce the PID adjustment, in favor of the constant of output.

6.10 P09 Special Function Parameter Group

P09.00	Jog Running Frequency	0.00Hz~P00.07	5.00Hz	<input type="radio"/>
P09.01	Jog Running Acceleration Time	0.0s~3600.0s	Model dependent	<input type="radio"/>
P09.02	Jog Running Deceleration Time	0.0s~3600.0s	Model dependent	<input type="radio"/>

Target frequency and Acceleration/down time when setting jog operation, Acceleration/down time is the time needed when speeding up to P00.16 selected reference frequency.

Note: the start frequency is neglected when jogging, DC brake devices, from 0 frequency to accelerate, decelerate to 0 frequency then stop run.

P09.03	Acceleration Time 1	0.0s~3600.0s	Model dependent	<input type="radio"/>
P09.04	Deceleration Time 1	0.0s~3600.0s	Model dependent	<input type="radio"/>
P09.05	Acceleration Time 2	0.0s~3600.0s	Model dependent	<input type="radio"/>
P09.06	Deceleration Time 2	0.0s~3600.0s	Model dependent	<input type="radio"/>
P09.07	Acceleration Time 3	0.0s~3600.0s	Model dependent	<input type="radio"/>
P09.08	Deceleration Time 3	0.0s~3600.0s	Model dependent	<input type="radio"/>

Acceleration/deceleration time refers to the time needed that frequency from 0.00 Hz acceleration/deceleration to the reference frequency (P00.16), which is used to set frequency changing slope. There Provide 4 groups of acceleration/deceleration time to selection, through digital input terminal to choose parameters (refer to P05 parameter group). If there is no terminal input option to acceleration/deceleration, then terminal selection is disabled, so acceleration/deceleration time is group 0 accordingly.

P09.09	Set Frequency Reaching Detection Amplitude	0.00Hz~P00.07	0.00Hz	<input type="radio"/>
--------	--	---------------	--------	-----------------------

When the output frequency is within positive/negative detecting range of preset frequency, DO output terminal output ON signal (the DO terminal has to set "set frequency arrival function). As below diagram (take MS speed set frequency to illustrate.):

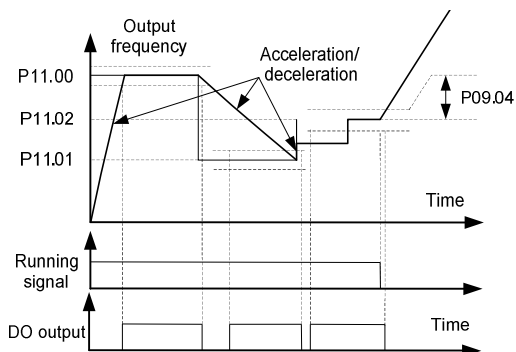

Fig 6.9-1 Diagram of Setting frequency arriving detecting amplitude

P09.10	Frequency Detection Value 1 (FDT1)	0.00Hz~P00.07	50.00Hz	○
P09.11	Frequency Detection 1 Hysteresis Value	0.0%~100.0% (relative to FDT1)	5.0%	○
P09.12	Frequency Detection Value 1 (FDT2)	0.00Hz~P00.07	50.00Hz	○
P09.13	Frequency Detection 2 Hysteresis Value	0.0%~100.0% (relative to FDT2)	5.0%	○

Frequency detection FDT function: when the output frequency exceeds set frequency detection value, DO indicator signal FDT output is Enabled, until the output frequency drop below detection value and the difference value exceeding the lagged value, DO indicator signal FDT output is Disabled. On the max extent to enabled setting 2 FDT detecting points at the same time.

FDT lag amplitude = FDT detection value* FDT lag value.

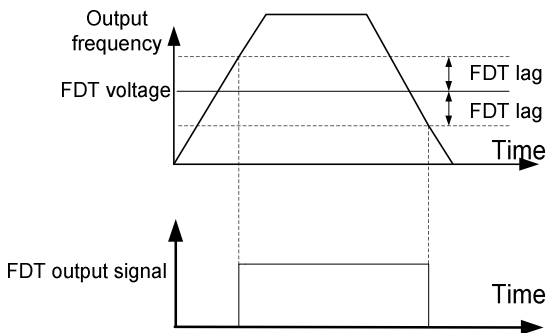

Fig 6.9-2 FDT signal diagram

P09.14	Swing Set Mode	0: Relative to the center frequency	0	●
P09.15	Swing Frequency Amplitude	0.0%: Close swing frequency function 0.1%~100.0%	0.0%	○
P09.16	Jump Frequency Amplitude	0.0%~50.0%	0.0%	○
P09.17	Swing Frequency Rise Time	0.0s~3000.0s	5.0s	○
P09.18	Swing Frequency Fall Time	0.0s~3000.0s	5.0s	○

The swing frequency function is applicable to the textile and chemical fiber fields and the applications where traversing and winding functions are required.

The swing frequency function means that the output frequency of the inverter swings up and down around the central of set frequency. The trace of running frequency at the time axis is shown in the figure below, of which the swing amplitude is set by P09.15. When P09.15 is set to 1, indicating the swing amplitude is 0, the swing frequency is disabled.

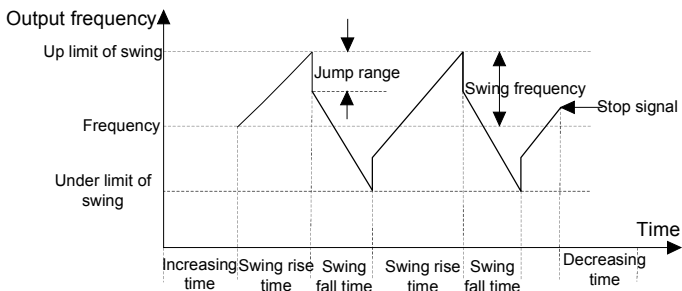

Fig 6.9-3 Schematic diagram for swing frequency work principle

Swing frequency set method is used to set swing amplitude reference quantity.

For central frequency (present set frequency) is relative to variable swing system. Swing amplitude changes according to central frequency changing.

Relative to max frequency is fixed swing amplitude system, the swing amplitude is fixed.

Swing amplitude: the frequency is restraint by upper/lower limit frequency.

Swing amplitude relative to central frequency: swing amplitude $AW = \text{central frequency} * \text{swing amplitude P09.15}$.

Swing amplitude relative to max frequency: swing amplitude $AW = \text{max frequency} * \text{swing amplitude P09.15}$.

Swing amplitude relative percentage set by Jump frequency amplitude P09.16, actual jump amplitude = swing amplitude $AW * \text{jump frequency amplitude P09.16}$.

Swing frequency rising time: the time needed run from the lowest point of swing frequency to the highest point.

Swing frequency falling time: the time needed falling from the highest point of swing frequency to the lowest point.

P09.19	Jump Frequency 1	0.00Hz~P00.07	0.00Hz	○
P09.20	Jump Frequency Amplitude 1	0.00Hz~P00.07	0.00Hz	○
P09.21	Jump Frequency 2	0.00Hz~P00.07	0.00Hz	○
P09.22	Jump Frequency Amplitude 2	0.00Hz~P00.07	0.00Hz	○
P09.23	Jump Frequency Amplitude 3	0.00Hz~P00.07	0.00Hz	○
P09.24	Jump Frequency Amplitude 3	0.00Hz~P00.07	0.00Hz	○

Swing frequency cycle: the sum of swing amplitude rising time and swing amplitude falling time

Jump frequency is that when target frequency fall within jump frequency range, actual run frequency will automatically adjust out of the jump frequency range to avoid mechanical resonance frequency point. As below diagram showed, actual run frequency fall onto the solid line:

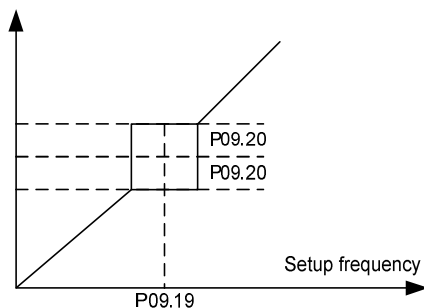

Fig6.9-4 Schematic diagram for Jump frequency

P09.25	Setting Length	0~65535	0	○
P09.26	Pulse Per Meter	0.1~6553.5	0	○

Above function code used to fix-length control.

The length information need through multi-function digit input terminal collect, the pulse number of terminal adopt divided with unit length corresponding to the pulse number P09.26, to calculate the actual length. When actual length more than set length P09.25, then multi-function digit DO output "length reached" ON signal.

During setting length process, can through multi-function DI terminal, doing length reset operation(DI function selection is 39), detail please refer P05.00~P05.05.

In application, need to set the corresponding input terminals function to "length counting input" (function 38), must use HDI1 port in higher pulse frequency.

P09.27	Set Count Value	P09.28~65535	1000	○
P09.28	Designated Count Value	1~P09.27	500	○

The count value can set counter input DI function. When count value arrive at set counter value, digital output terminal output signal set by counter and counter stop counting. When the count value reaches the designated count value, the digital output terminal will output signal of designated counting value. The counter will continue count till the "setup counting value" is reached. The designated count value shall not exceed the setup count value.

Counter input DI function recommend using HS DI (HDI) terminal receipt, if input signal frequency is lower (<500Hz), can also use ordinary DI terminal.

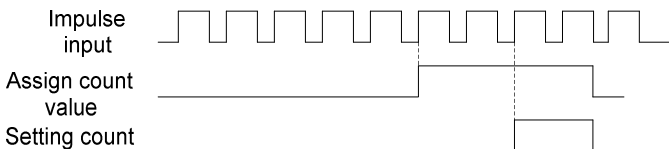

Fig 6.9-5 Diagram of setup counting value and designated counting value

P09.29	Droop Control Frequency Drop Rate	0.00Hz~10.00Hz	0.00Hz	<input type="radio"/>
--------	---	----------------	--------	-----------------------

This parameter adjust the inverter frequency change ratio of speed sagging. When several units of inverter drive the same load at the same time, due to speed variation resulting in load distribution unbalance, the inverter with higher speed will bear heavier load. The sagging control function can make speed sagging following the load increasing so to balance the load distribution.

P09.30	Accumulative Running Time Reached	0h~65535h	0h	<input type="radio"/>
P09.31	Accumulative Power-On Time Reached	0h~65535h	0h	<input type="radio"/>
P09.32	Current Running Time Reached	0min~65535min	0min	<input type="radio"/>
P09.33	Current Power-On Time Reached	0min~65535min	0min	<input type="radio"/>

The function code is used to set their own time of arrival, when the setting time, digital output terminals output corresponding DO signals (21 ~ 24 function).

P09.34	Any Frequency Reaching	0.00Hz~P00.07	0.00Hz	<input type="radio"/>
P09.35	Any Frequency Reaching Detection Amplitude	0.00Hz~P09.34	0.00Hz	<input type="radio"/>

When output frequency is within the positive/negative detecting width range of any set frequency, DO output terminal output ON signal (the DO terminal has to be set as "random arrival frequency function"). As below diagram:

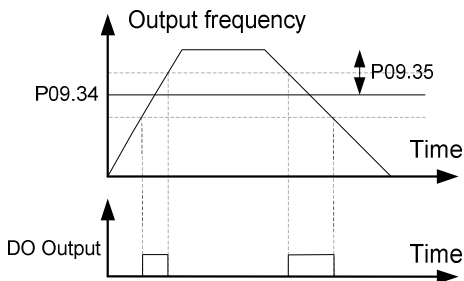

Fig 6.9-6 random arrival frequency detecting diagram

P09.36	Any Current Reaching	0.0%~300.0%	0.0%	○
P09.37	Any Current Reaching Detection Amplitude	0.0%~P09.36	0.0%	○

When output frequency is within positive/negative detection width range in any set current, DO output terminal output ON signal (the DO terminal has to be set as “random arrival current function”). As below diagram:

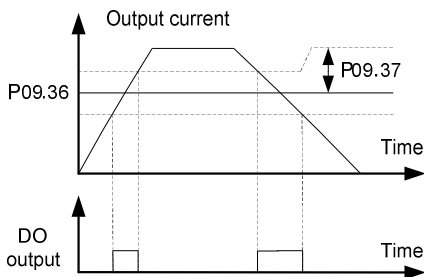

Fig 6.9-7 Random arrival current detecting diagram

P09.38	Electricity Consumption Initial Value Upper Bit	0kwh~60000kwh	0kwh	○
P09.39	Electricity Consumption Initial Value Lower Bit	0.0kwh~999.9kwh	0.0kwh	○

Used to set electricity consumption initial value. Electricity consumption initial value = $P09.38 \times 1000 + P09.39$ (°).

P09.40	Inverter Input Power Factor	0.00~1.00	0.86	○
--------	-----------------------------	-----------	------	---

Used to adjust AC input side current display value

P09.41	Keypad \wedge /V Fine Tuning Frequency and JOG/REV Fast Frequency Set	0x0000~0x1221 LED unit's digit: frequency control selection 0: Adjusting enabled 1: Keypad adjusting disabled LED ten's digit bit: frequency control selection 0: Only enabled when P00.02=1 or P00.03=1 1: All frequency mode are enabled 2: MS speed in priority, disabled for MS speed LED hundred's digit: stop action selection 0: Setup enabled 1: Enabled in run, clear after stop 2: Enabled in run, clear upon receiving stop command LED thousand's digit: \wedge /v key integration function 0: Integration function enabled 1: Integration function disabled	0x0000	○
--------	---	--	--------	---

Used to set inverter keypad \wedge /v key function selection.

P09.42	\wedge /V Key Integration Rate	0.1s~10.0s	1.0s	○
--------	----------------------------------	------------	------	---

If select \wedge /v key integration function Enabled, the parameter is used to set \wedge /v key integration rate value, the bigger the value is, the smaller the change rate is.

P09.43	UP/DOWN Terminal Control Setup	0x000~0x221 LED unit's digit: frequency control selection 0: UP/DOWN terminals setting enabled 1: UP/DOWN terminals setting Disabled LED ten's digit: frequency control selection 0: Only enabled when P00.02=1 or P00.03=1 1: All frequency mode are enabled 2: When the multi-step speed are priority, it is disabled to the multi-step speed LED hundred's digit: action selection when stop 0: Setting enabled 1: Enabled in run , clear after stop 2: Enabled in run , clear upon receiving stop command	0x000	○
--------	--------------------------------	---	-------	---

Used to set terminal UP/DOWN function selection

P09.44	UP/DOWN Terminals Frequency Change Rate	0.01Hz/s ~50.0Hz/s	1.00Hz/s	○
--------	---	--------------------	----------	---

If choosing terminals UP/DOWN function, set the parameters used in the terminal UP/DOWN the size of the function change rate, the greater the value, the greater the rate of change.

P09.45	Frequency Setting at Power Loss Action Selection	0x000~0x111 LED unit's digit: action selection when digital adjustment frequency with power off 0: Save when power off 1: Clear when power off LED ten's digit: action selection when Modbus setting frequency power off 0: Save when power off 1: Clear when power off LED hundred's digit: action selection when other Communication set frequency power off 0: Save when power off 1: Clear when power off	0x000	○
--------	--	--	-------	---

Used to set when the inverter power electricity again, select whether frequency is memory or storage when power failure.

P09.46	PWM Selection	0x00~0x21 LED unit's digit: PWM mode selection 0: PWM mode 1, PWM mode1, 3phase modulation and 2phase -modulation 1: PWM mode2, three-phase modulation LED ten's digit: PWM low speed carrier limit 0: Low speed carrier limit, carrier limit mode 1 1: Low speed carrier limit, carrier limit mode 2 2: Low speed carrier no-limit	0x01	◎
--------	---------------	--	------	---

Used to set the PWM's adjust method of inverter output and the limit of carrier frequency switch.

P09.47	Zero Frequency Output Selection	0: No voltage output 1: Voltage output 2: According to the stop DC braking current output	0	○
--------	---------------------------------	---	---	---

Used to set the output of the inverter at zero frequency output mode selection. Such as system at zero frequency runtime motor need to keep a certain tension and torque in order to maintain system can set the appropriate parameters to achieve purpose.

P09.48	Action after Accumulative Power-On and Run Time Reached	0: Output terminals action, error alarm 1: Output terminals action, no error alarm	0	<input type="radio"/>
--------	---	---	---	-----------------------

Used to set whether inverter will alarm when the accumulative power-on and run time reached.

Output terminal action, error alarming: the inverter output DO action and meanwhile alarming Er027(if run time arrived) or alarming Er08(power-on time reached) and instantly stop.

Output terminal action, no alarming fault: the inverter only output DO action, such as run signal effectively, will continue to keep run status.

P09.49	Motor Power Correction Coefficient	0.00%~200.0%	100.0%	<input type="radio"/>
--------	------------------------------------	--------------	--------	-----------------------

Used to correct motor power coefficient.

P09.50	User-Defined Fault Selection	LED unit's digit 0: Disabled run after fault 1: Jog running after fault LED ten's digit 0: Coast to stop 1: Decelerate to stop	0x00	<input type="radio"/>
--------	------------------------------	---	------	-----------------------

Used to set inverter disposal method after receiving user defined error input signal.

P09.55	Jog Preferred Selection	0: Enabled 1: Disabled	0	<input type="radio"/>
--------	-------------------------	---------------------------	---	-----------------------

When jog run is priority to choose, inverter has received the operation signal, receiving jog run signal again, priority jog run signal, otherwise, the first received signal.

P09.56	Auto-start Selection after Manual Reset	0: Disabled 1: Enabled	0	<input type="radio"/>
--------	---	---------------------------	---	-----------------------

Manual reset from the start allows the inverter in the running due to the failure signal and the shutdown, manual reset the fault, the inverter will start again.

6.11 P10 Keyboard and Display

P10.00	STOP/RESET Key Stop Function	0: Only enabled to keyboard control panel 1: Enabled to control panel and terminals at the same time 2: Enabled to control panel and communication at the same time 3: Enabled to all control mode	0	○
--------	------------------------------	---	---	---

This parameter is used to set STOP/RESET key function selection.

RESET function is always Enabled, no matter what value is set for the parameter.

P10.01	REV/JOG Key Function	0: No function 1: Jog running 2: FWD/REV switchover 3: Coast to stop 4: Clear up/down & ^v key setup frequency 5: Shift key switchover display state 6: Realize run command pre-set mode according to sequence switchover 7: Quick debugging mode(according to factory parameter debugging) 8: Modify rapidly set frequency	1	◎
--------	----------------------	---	---	---

This parameter is used to set JOG/REV button function selection

P10.02	JOG/REV Key Run Command Channel Switchover Sequential Selection	0: Keyboard control ←→ terminal control 1: Keyboard control --communication control 2: Terminal control ←→communication control 3: Keyboard control →terminals Control →communication control	3	○
--------	---	--	---	---

When P10.01 set as 6, this parameter is used to set JOG/REV button function selection.

P10.03	LED Running Display Parameter 1	0x0000~0xFFFF BIT0: Running frequency (Hz light on) BIT1: Sett frequency(Hz flash) BIT2: Bus voltage(V light on) BIT3: Output voltage(V light on) BIT4: Output current(A light on) BIT5: Run speed(RPM on) BIT6: Output power(% light on) BIT7: Output torque (% light on) BIT8: PID setting value BIT9: PID Feedback value BIT10: State of input terminals BIT11: State of output terminals BIT12: Torque setting value (% light on) BIT13: Pulse counting value BIT14: Current stage in multi stage-speed BIT15: Slope frequency setting value (Hz light on)	0x3F	○
P10.04	LED Running Display Parameter 2	0x0000~0xFFFF BIT0: Analog AI1 value (V light on) BIT1: Reserved BIT2: Reserved BIT3: Reserved BIT4: Motor overload percentage(% light on) BIT5: Inverter overload percentage(% light on) BIT6: Length BIT7: Excitation current (A light on) BIT8: Torque current (A light on) BIT9: AC input current (A light on) BIT10: User-defined speed	0x000	○

		1(running value) BIT11: User-defined speed 2(running value) BIT12~BIT15: Reserved		
--	--	--	--	--

Inverter in run condition, parameter display is subjected to the function code, which is a 16 bit binary number, if one bit is 1, the corresponding parameters of the bit at run time, can see through the shift key. If the bit is 0, then the corresponding parameters will not be displayed. The lower the bit is, the higher the display priority is.

Comparison table of operating display low bit P10.03		Comparison table of operating display low bit P10.04	
Corresponding display parameter	Hexadecimal	Corresponding display parameter	Hexadecimal
Running frequency(Hz ON)	0x0001	AI1 voltage(V ON)	0x0001
Setting frequency(Hz flash)	0x0002		
Bus voltage(V ON)	0x0004		
Output voltage(V ON)	0x0008	HS pulse HDI frequency	0x0008
Output current(A ON)	0x0010	Motor overload percentage(% ON)	0x0010
Motor rotating speed(RPM ON)	0x0020	Inverter overload percentage(% ON)	0x0020
Output power(% ON)	0x0040	Linear speed	0x0040
Output torque(% ON)	0x0080	Excitation current(A ON)	0x0080
PID setting value(% flash)	0x0100	Torque current(A ON)	0x0100
PID feedback value(% ON)	0x0200	AC line-in current (A ON)	0x0200
Input terminal state	0x0400		
Output terminal state	0x0800		
Torque setting value(% ON)	0x1000		

Pulse counting value	0x2000		
MC speed present stage	0x4000		
Slope frequency setting value(Hz ON)	0x8000		

Example 1: for example while runtime only need to display motor rotating speed, other parameters do not need to be displayed.

Motor rotating speed display is at lower bit P10.03, corresponding hexadecimal 0x0020, run display high bit parameter is 0, then set P10.03=0*0020, P10.04=0x0000.

Example 2: such as constant pressure water supply system only need to display the real-time pressure value, which shows the inverter PID feedback, other parameters do not need to display. PID feedback in shown at low bit P10.03 which corresponding hexadecimal 0x0200, run shown high bit is all 0, and set P10.03 = 0 x0200, P10.04 x0000 = 0.

Note: if need to display the pressure units at run time, it must be properly set P08.05 parameters.

Example 3: such as the need to display the operation of the inverter frequency and the output current and other parameters are not displayed. Inverter output frequency is in the run showed low P10.03, corresponding to the hex 0 x0001; Inverter output current is in the run showed low P10.03, corresponding to the hex 0 x0010; This set P10.03 = 0 x0001 + 0 x0010 = 0 x0011, P10.04 x0000 = 0. At this time to shift by pressing the shift key until the operation of the need to look at the inverter frequency and the output current.

P10.05	LED Stop Display	0x0000~0xFFFF BIT0: Set frequency (Hz flash) BIT1: Bus voltage (V light on) BIT2: State of input terminals BIT3: State of output terminals BIT4: PID setting value (% flash) BIT5: PID Feedback value (% on) BIT6: Torque setting value (% on) BIT7: Analog AI1 (V light on) BIT8: Reserved BIT9: Reserved BIT10: Reserved BIT11: Current stage in multi stage-speed BIT12: Pulse count value	0x03	○
--------	------------------	---	------	---

		BIT13: User-defined speed 1(setting value) BIT14: User-defined speed 2(setting value) BIT15: Length		
--	--	---	--	--

Inverter in stop state, the parameters according to the function code, which is a 16 bit binary number, if one is 1, then the corresponding parameters can be during downtime, can see through the shift key. If the bit is 0, then the corresponding parameters will not be displayed. The lower bits, the higher the display priority is. Please refer to the operation display parameters detailed setting method.

Stop display parameter P10.05 corresponding table	
Corresponding display parameter	Hexadecimal
Set frequency (Hz on)	0x0001
Bus voltage (V on)	0x0002
Input terminal state	0x0004
Output terminal state	0x0008
PID given value (% flash)	0x0010
PID feedback value (% on)	0x0020
Torque set value (% on)	0x0040
Analog AI1 value (V on)	0x0080
HS pulse HDI frequency (Optional)	0x0400
MS speed present stage	0x0800
Pulse count value	0x1000
User-defined speed 1 (Set value)	0x2000
User-defined speed 2 (Set value)	0x4000
Length	0x8000

P10.06	User-Defined Speed 1 Coefficient	0.00~60.00 User-defined speed= Running frequency*P10.06	1.00	○
--------	----------------------------------	--	------	---

Used for correct the display the coefficient of user-defined speed 1. After user change the user-defined speed 1 coefficient, inverter LED displayed actual frequency = frequency * P10.06.

P10.07	User-Defined Speed 2 Coefficient	0.00~60.00 User-defined speed= mechanic RPM*P10.07	1.00	<input type="radio"/>
--------	----------------------------------	---	------	-----------------------

Used for correct the coefficient of load speed display. After user changing the user-defined speed 2 coefficient, inverter LED actual display user-defined speed 2 = RPM* P10.07.

P10.09	LED Running Display Parameter in Second Line	0~15: Corresponding bit0~bit15 of P10.03 16~31: Corresponding bit0~bit15 of P10.04	4	<input type="radio"/>
P10.10	LED Stop Display Parameter in Second Line	0~15: Corresponding bit0~bit15 of P10.03	1	<input type="radio"/>

When using the double line display keypad, can selected a display value through these two parameters, but the parameter is the decimal input.

6.12 P11 MS Speed Function

MS frequency given as frequency mode is applied in MS speed run mode and simple reserved run mode. When frequency source command A or B is selected as MS speed command, inverter run frequency is MS speed mode.

P11.00	The frequency of Paragraph 0	-100.0%~100.0%	0.0%	<input type="radio"/>
P11.01	The frequency of Paragraph 1	-100.0%~100.0%	0.0%	<input type="radio"/>
P11.02	The frequency of Paragraph 2	-100.0%~100.0%	0.0%	<input type="radio"/>
P11.03	The frequency of Paragraph 3	-100.0%~100.0%	0.0%	<input type="radio"/>
P11.04	The frequency of Paragraph 4	-100.0%~100.0%	0.0%	<input type="radio"/>
P11.05	The frequency of Paragraph 5	-100.0%~100.0%	0.0%	<input type="radio"/>
P11.06	The frequency of Paragraph 6	-100.0%~100.0%	0.0%	<input type="radio"/>
P11.07	The frequency of Paragraph 7	-100.0%~100.0%	0.0%	<input type="radio"/>
P11.08	The frequency of Paragraph 8	-100.0%~100.0%	0.0%	<input type="radio"/>
P11.09	The frequency of Paragraph 9	-100.0%~100.0%	0.0%	<input type="radio"/>
P11.10	The frequency of Paragraph 10	-100.0%~100.0%	0.0%	<input type="radio"/>
P11.11	The frequency of Paragraph 11	-100.0%~100.0%	0.0%	<input type="radio"/>
P11.12	The frequency of Paragraph 12	-100.0%~100.0%	0.0%	<input type="radio"/>
P11.13	The frequency of Paragraph 13	-100.0%~100.0%	0.0%	<input type="radio"/>
P11.14	The frequency of Paragraph 14	-100.0%~100.0%	0.0%	<input type="radio"/>
P11.15	The frequency of Paragraph 15	-100.0%~100.0%	0.0%	<input type="radio"/>

MS speed command 100.0% is corresponding max output frequency P00.07, minus sign stand for reverse run. The inverter can set 16stage speed, selected by combined code via external terminal DIn1, DIn2, DIn3, DIn4, separately corresponding to MS speed 0 to MS speed 15.

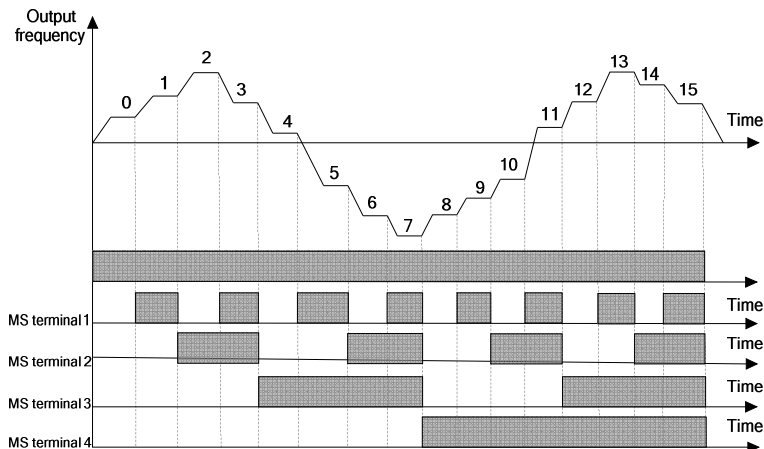

Fig 6.12-1 Multistage speed operation schematic diagram

As shown in the above, when only need 2 stages of speed then one input terminal is required, by the same token, when there need 3~4 stages of speed then two input terminals are required, and when there need 5 ~ 8 stages of speed then three input terminal are required, and when there need 9~16 stages of speed then 4 input terminal are required.

16 stage speed operating logic diagram DIn1 = DIn2 = DIn3 = DIn4 = OFF, the frequency setup mode of multistage speed command 0 is set by the code P00.12. DIn1 = DIn2 = DIn3 = DIn4 terminal is not all OFF, multistage speed operating, the priority of the multistage speed is higher than the keyboard, , analogue, HS pulse, PLC, communication frequency input, via DIn1, DIn2, DIn3, DIn4 combined coding, there is 16stage speed to be chosen on max extent.

The start/stop of MS speed operating is also decided by P00.01, the relation between DIn1, DIn2, DIn3, DIn4 terminals and multistage speed is shown in the following table.

DIn1	OFF	ON	OFF	ON	OFF	ON	OFF	ON	OFF	ON	OFF	ON	OFF	ON	OFF	ON
DIn2	OFF	OFF	ON	ON	OFF	OFF	ON	ON	OFF	OFF	ON	ON	OFF	OFF	ON	ON
DIn3	OFF	OFF	OFF	OFF	ON	ON	ON	ON	OFF	OFF	OFF	OFF	ON	ON	ON	ON
DIn4	OFF	OFF	OFF	OFF	OFF	OFF	OFF	OFF	ON	ON	ON	ON	ON	ON	ON	ON
	0	1	2	3	4	5	6	7	8	9	10	11	12	13	14	15

 **WARNING**

- The MS speed command priority is the highest in all frequency command sources, when the multistage speed arbitrary terminals function is Enabled, multistage speed command is preferred.

6.13 P13 Protection Function Parameters Group

P13.00	Motor Overload Protection Selection	0: Disabled 1: Ordinary motor(with low speed compensation) 2: Variable frequency motor (without low speed compensation)	1	<input type="radio"/>
P13.01	Motor Overload Protection Factor	20.0%~200.0%	100.0%	<input type="radio"/>

Start motor overload software protection function, via checking the inverse time limit curve feature when inverter has motor overload protection, in order to judge if motor is in overload state.

Closing motor overload software protection function, may has the risk of overheat damage to motor, it is highly recommended to add a thermal relay between inverter and motor to protect motor when setting the parameter.

The inverse time limit curve of motor overload protection default as: 200% motor rate current, last 1min then alarming motor overload error; 120% motor rate current, keep 60min then alarming motor overload error. Via adjusting motor overload protection coefficient to smoothening motor overload curve, to meet the actual application of specific motor.

The bigger the overload protection coefficient is, the longer the overload time is.

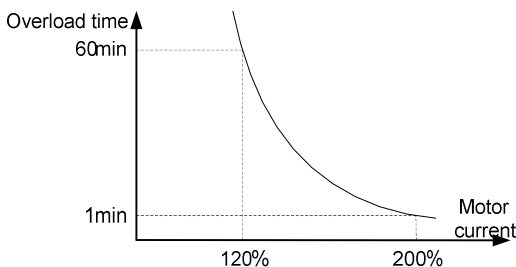

Fig 6.12-1 Motor overload curve

P13.04	Overload Warning Detection level	50%~200%	G: 150%	<input type="radio"/>
			P: 120%	
P13.05	Overload Warning Detection Time	0.0s~3600.0s	1.0s	<input type="radio"/>

Inverter or motor overload pre-alarming detection level: before inverter or motor overload error protection, through DO send a pre-alarm signal to control system. The

pre-alarm factor is to decide what time to pre-alarm before inverter or motor overload protection. The bigger the value is, the smaller the pre-alarm advanced quantity is.

Inverter or motor overload pre-alarming detection time: DO output overload pre-alarm signal, when overload pre-alarm occurred and greater than overload pre-alarm detection time. As below diagram:

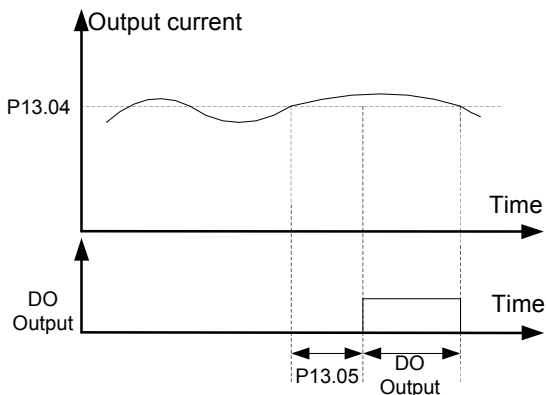

FIG 6.12-2 Detection of overload pre-alarm

P13.06	Offload Warning Detection level	0%~P13.04	50%	○
P13.07	Offload Warning Detection Time	0.0s~3600.0s	1.0s	○

Inverter or motor offload pre-alarm detection level : before inverter or motor offload error protection, through DO send a pre-alarm signal to control system. The pre-alarm coefficient is to decide what time to pre-alarm before inverter or motor offload protection. The bigger the value is, the bigger the pre-alarm advanced quantity is.

Inverter or motor offload pre-alarm detection time: DO output offload pre-alarm signal, when offload pre-alarm occurred and greater than offload pre-alarm detection time. As below diagram:

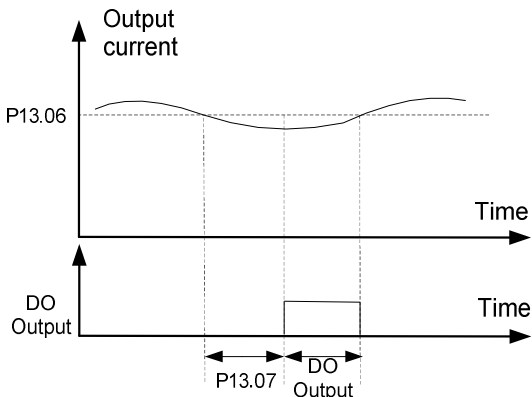

FIG 6.12-3 Offload pre-alarm detection

P13.08	Inverter or Motor Overload/Offload Warning Selection	0x000~0x131 Led unit's digit: 0: Motor overload/offload warning, relative to the rated current of the motor 1: Inverter overload/offload warning, relative to the rated current of inverter Led ten's digit: 0: Inverter continues to work after overload/offload warning 1: Inverter continues to work after offload warning and stop to run after overload warning 2: Inverter continues to work after overload alarm and stop to run after offload warning 3: Inverter stops after offload/overload warning Led hundred's digit: 0: Detection all the time 1: Detection in the constant speed run	0x000	○
--------	--	---	-------	---

The parameter is used to whether to selecting inverter pre-alarm function or motor pre-alarm function etc.. Such as pre-alarm detection method and the disposal method after pre-alarmed.

P13.09	Output Over-current Detection Value	0.0%: No detection 0.1%~300.0%	0.0%	<input type="radio"/>
P13.10	Output Over-current Detection Time	0.0s~100.0s	0.0s	<input type="radio"/>
P13.11	Output Over-current Action	0: Terminal output 1: Terminal output, alarm Er016 2: Terminal output, alarm Er016 when constant speed run 3: Terminal output in the constant speed run	0	<input type="radio"/>

This group of function code is used to set detecting motor output current, output current over limit detection delay time, DO action and inverter to detection result whether do the fault handling etc. If choose error alarming then inverter will stop run. As below diagram:

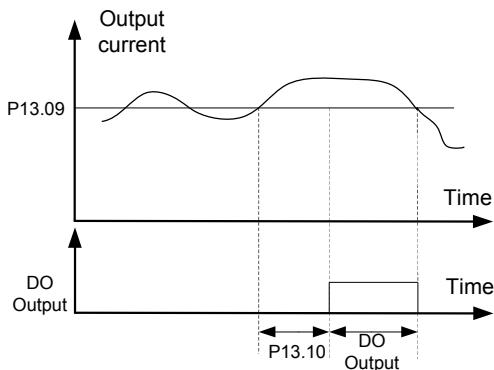

FIG 6.12-4 Diagram of output current over limit detecting

P13.12	Overvoltage Stall Protective	0: Disabled 1: Enabled	0	<input type="radio"/>
P13.13	Overvoltage Stall Protective Voltage	120%~150% (standard bus voltage)	380VAC: 140%	<input type="radio"/>
			220VAC: 120%	

Used for setting the overvoltage threshold voltage of inverter DC bus and overvoltage whether to open stall protection. For larger inertia but with no configured braking circuit, if prohibit overvoltage stall protection inverter will easily jump over overvoltage error, if open overvoltage stall protection then resulting in inverter actual decelerating time will be delayed. If inverter built-in braking unit and configured braking resistor. P13.13 is the braking unit threshold voltage when overvoltage.

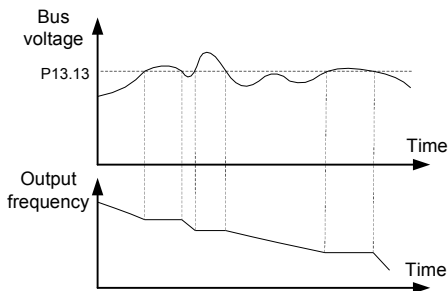

Fig 6.12-5 Diagram of over voltage under speed

P13.14	Dynamic Brake Enabled	0: Disabled 1: Enabled	1	<input type="radio"/>
P13.15	Dynamic Brake Voltage	200.0VDC~2000.0VDC	220VAC: 380.0VDC	<input type="radio"/>
			380VAC: 700.0VDC	
			660VAC: 1120VDC	

The above parameter is used to open inverter energy consumption braking voltage threshold, when inverter configured brake unit.

P13.16	Current Limit Selection	0x00~0x11 Unit's digit: current limiting action selection 0: Current limiting action disabled 1: Current limiting action Enabled Ten's digit: hardware current limiting overload alarm selection 0: Hardware current limiting overload alarm enabled 1: Hardware current limiting overload alarm disabled	0x01	<input checked="" type="radio"/>
--------	-------------------------	---	------	----------------------------------

P13.17	Auto Current Limit Level	50.0%~200.0%	G type: 160.0%	⊙
			P type: 120.0%	
P13.18	Frequency Droop Rate When Current Limiting	0.00Hz/s ~50.00Hz/s	10.00Hz/s	⊙

Overcurrent stall is similar to overvoltage stall, when inverter is in starting acceleration process, then inverter output frequency stop acceleration and keep current running frequency, waiting until output current lower than stall upper limit then starting acceleration. As Fig 6.12-6 showed.

If inverter in constant speed operation, load jump and result in inverter output current exceeding overcurrent stall upper limit, the output frequency of inverter will decrease as P13.18 set and keep decreasing until inverter output current less than P13.17 setting threshold value. As Fig 6.12-6 in constant speed operation:

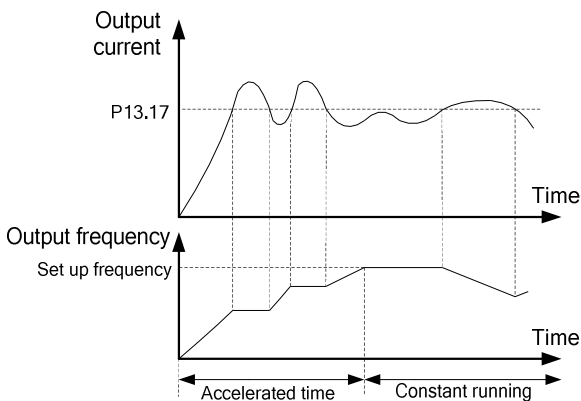

Fig 6.12-6 Diagram for over-current stall protection

P13.19	Phase Loss Protection	0x00~0x11 Led unit's digit: 0: Input phase loss protection disabled 1: Input phase loss protection enabled Led ten's digit: 0: Output phase loss protection disabled 1: Output phase loss protection enabled	0x11	○
--------	-----------------------	--	------	---

		Remark: the machine less than 11kW have no input phase loss protection		
--	--	--	--	--

The above parameter is used to select whether to provide protection for Input or output phase failure. Only the VD series inverter of G model with over 11kW can have input phase loss protection function.

P13.20	Frequency Reduction Function Selection when an Instantaneous Power Failure	0: Disabled 1: Enabled	0	<input type="radio"/>
P13.21	Frequency Reduction Mode Selection when an Instantaneous Power Failure	0~1	10.0s	<input type="radio"/>
P13.22	Frequency Decrease Rate when an Instantaneous Power Failure (P13.21=0 Enabled)	0.00Hz/s~50.00Hz/s	10.00Hz/s	<input type="radio"/>
P13.23	Deceleration Time when an Instantaneous Power Failure (P13.21=1 Enabled)	0.0s~600.0s	5.0s	<input type="radio"/>
P13.24	Estimate Voltage when an Instantaneous Power Failure	200.0VDC~600.0V DC	380VAC: 420.0VDC	<input type="radio"/>
			220VAC: 240.0VDC	

This function means that when instant power failure or voltage suddenly drop, inverter output speed will decrease and load feedback energy will compensate to drop of inverter DC bus voltage, in order to keep inverter run and avoid under voltage error caused stopping.

P13.20 is used in selecting protection function in instantaneous power failure, P13.21 is used in frequency reduction mode selection when an instantaneous power: 0 is frequency decrease according to P13.22 frequency decrease rate. When bus voltage is low or instantaneous power failure and P13.20=1, then inverter output frequency will judge and interfere inverter output frequency according to P13.21 selection mode and P13.22 set value, will normal run until bus voltage recovery.

P13.25	Short-circuit to Ground Upon Power-on	0: Enabled 1: Disabled	0	<input type="radio"/>
--------	---------------------------------------	---------------------------	---	-----------------------

To check if motor is short circuit to ground when inverter powered on, if selecting detection enabled, inverter output terminal U, V, W has voltage output after powered on for a short period, it is used to check if motor is short circuit to ground or not.

P13.26	Fault Output Terminals Action Selection during Fault	0x00~0x11 Led unit's digit: 0: Action upon under-voltage error 1: No action upon under-voltage error Led ten's digit: 0: Action during auto reset 1: No action during auto reset	0x00	<input type="radio"/>
--------	--	--	------	-----------------------

Used to select fault output terminals in the under-voltage and fault automatic reset action.

P13.27	Fault Auto Reset Time	0~20	0	<input type="radio"/>
--------	-----------------------	------	---	-----------------------

When the inverter selects fault auto reset, it is used to set the times of auto reset. If fault times exceeded this parameter value, the inverter will keep error status.

P13.28	Time Interval of Fault Reset	0.1s~3600.0s	1.0s	<input type="radio"/>
--------	------------------------------	--------------	------	-----------------------

The parameter is used to set the interval time from inverter error alarming to auto reset error. If inverter occurred error within the interval time then inverter will not reset and give alarming.

P13.29	Fan Start Mode	0: Automatic control 1: Fan keep run	0	<input type="radio"/>
--------	----------------	---	---	-----------------------

Used to select a cooling fan mode of action, choosing to 0, the run state of the inverter in the fan operation, stop state if the radiator temperature is above 40 degrees fan operation, stop condition radiator temperature below 40 degrees fan doesn't work. This mode can greatly improve the service life of the cooling fan.

Choose to 1, the fan has been run after the inverter to electricity.

P13.30	Automatic Frequency Reduction Selection when Voltage Reduction	0: Disabled 1: Enabled	0	<input type="radio"/>
--------	--	---------------------------	---	-----------------------

P13.31	Automatic Frequency Reduction Point when Voltage Reduction	200.0V~600.0V	380VAC: 513.0VDC	○
			220VAC: 297.0VDC	

When the voltage drop but the automatic frequency reduction function is effective, the inverter can guarantee the output rated torque when the grid voltage drops to the voltage automatic frequency drop point.

P13.32	Emergency Stop Time	0.0s~3600.0s	5.0s	○
--------	---------------------	--------------	------	---

Combined with DI function 24 emergency stop time, decided to stop time.

6.14 P14 Error Record Parameter Group

P14.00	Fault Record Selection	0~3 (0: current fault, 1: Last fault, ID is larger, the earliest failure)	0	○
--------	------------------------	--	---	---

This parameter is used to select the user needs to check when failure keep records.

Note: the bigger the ID number is, the earlier the inverter failure time is

Error code	Error code description	Error code	Error code description
0	No fault	Er001	Acceleration run overcurrent(hardware)
Er002	Deceleration run overcurrent(hardware)	Er003	Constant speed run overcurrent (hardware)
Er004	Acceleration run overcurrent(software)	Er005	Deceleration run overcurrent (software)
Er006	Constant speed run overcurrent (software)	Er007	Acceleration run overvoltage
Er008	Deceleration run overvoltage	Er009	Constant speed run overvoltage
Er010	Bus under voltage	Er011	Motor overload
Er012	Inverter overload	Er013	Input side phase loss
Er014	Output side phase loss	Er015	Module overheat
Er016	Current over limit fault	Er017	External fault
Er018	Communication fault	Er019	Current detecting circuit fault
Er020	Motor self-learning error	Er021	EEPROM read-write fault
Er022	PID feedback over limit fault	Er023	PID feedback break line fault
Er024	Short circuit to ground upon power on	Er025	Reserved
Er026	Reserved	Er027	Running time reached
Er028	Power-on time reached	Er029	Offload
Er030	Reserved	Er031	Reserved
Er032	Reserved	Er033	Reserved
Er034	Reserved	Er035	Reserved
Er036	Electronic overload	Er037	User-defined fault

Er041	User-defined fault 1	Er042	Reserved
Er043	Reserved	Er044	Reserved
Er060	manufacturer defined fault 1	Er061	manufacturer defined fault 2

This parameter is used to display the failure code when user check over the error record. If the displaying is 0 that is no error record.

P14.02	Run Frequency upon Fault	0.00Hz~650.00Hz	0.00Hz	●
P14.03	Current Upon Fault	0.0A~2000.0A	0.0A	●
P14.04	Output Voltage upon Fault	0V~2000V	0V	●
P14.05	Bus Voltage upon Fault	0.0V~2000.0V	0.0V	●
P14.06	Input Terminal State upon Fault	0x00~0x3F	0x00	●
P14.07	Output Terminal State upon Fault	0x00~0x1F	0x00	●
P14.08	Inverter Temperature upon Fault	-20.0°C ~120.0°C	0.0°C	●
P14.09	Run Time upon Fault	0min~65535min	0min	●
P14.10	Power-On Time upon Fault	0min~65535min	0min	●
P14.11	Accumulative Running Time upon Fault	0h~65535h	0h	●
P14.12	Accumulative Power-On Time upon Fault	0h~65535h	0h	●

6.15 P15 Modbus Communication Parameter Group

P15.00	Communication Protocol Selection	0: Modbus	0	●
--------	----------------------------------	-----------	---	---

This parameter is used to select the inverter serial communication protocol type of communication.

P15.01	Local Address	0: Broadcasting address 1~247: slave address	1	○
--------	---------------	---	---	---

When the host is writing data frame, the slave communication address set to 0, as the broadcast address, all the slaves from Modbus will accept the frame but slaves without response.

The machine address has uniqueness in the communication network, which is to achieve the basis of point to point communication of HOST pc and inverter.

Note: when you need to read the inverter run data, the slave address cannot be set as 0.

P15.02	Baud Rate	0: 1200bps 1: 2400bps 2: 4800bps 3: 9600bps 4: 19200bps	3	○
--------	-----------	---	---	---

This parameter is used to set data transfer rate between the HOST PC and inverter.

Note: the HOST pc and inverter set baud rate must be the same, otherwise, the communication can't be done. The bigger the baud rate is, the faster the communication speed is. But it is easy to be interfered by external environment, please choose according to peripheral environment.

P15.03	Data Format	0: No check (N,8,1)for RTU 1: Even parity check (E,8,1)for RTU 2: Odd parity check (O,8,1)for RTU 3: No check (N,8,2)for RTU 4: Even parity check (E,8,2)for RTU 5: Odd parity check (O,8,2)for RTU	0	○
--------	-------------	--	---	---

This parameter is used to set the communication format between HOST PC and inverter. HOST PC and inverter setting data format must be the same, otherwise, communication cannot be done.

P15.04	Response Delay	0ms~200ms	5ms	○
--------	----------------	-----------	-----	---

Response delay time: refers to the interval time from inverter data receipt ends to sending response data to HOST PC. If response delay is less than system disposal

time, then response delay take system disposal time as reference, if response delay is longer than system disposal time, then after system disposal of date, then waiting delay until response delay time arriving to send out data to HOST PC.

P15.05	Communication Timeout Detection Time	0.0s: No detection 0.1s~100.0s	0.0s	○
--------	--------------------------------------	-----------------------------------	------	---

When the function code is set to 0.0 s, communication timeout parameter is Disabled. When the function code set to enabled values, if the interval time between a communication and the next communication beyond the communication timeout, system will be submitted to the communication failures Er018. Usually, it is set into is disabled. If in the continuous communication system, set this parameter, you can monitor the communication status.

P15.06	Transmission Error Handling	0: Alarm and coast to stop 1: No alarm and continue to run 2: No alarm and stop according to the stop mode(only under the communication control mode) 3: No alarm and stop according to the stop mode (under all control mode)	0	○
--------	-----------------------------	---	---	---

When set up the communication timeout detection, this parameter is used to set the inverter action method after communication.

P15.07	Communication Processing Action Selection	0x00~0x11 Led unit's digit: 0: Write with responds 1: Write without responds Led ten's digit: 0: Communication encrypting no limit 1: Communication encrypting with limit	0x00	○
--------	---	---	------	---

The parameter is used to set whether inverter will response data in communication and whether communication encryption setup is enabled.

Write operation with response: inverter responses data to host PC for read write command.

Write operation with no response: inverter only responses data to host PC read command, no response data to write command, helpful for improving communication efficiency.

Communication encryption setting is disabled: communication is not limited by user password encryption.

Communication encryption setting is enabled: communication is limited by user password encryption.

P15.08	Communication to Modify P00.01 Selection	0: Enable modify 1: Disable modify	1	
--------	--	---------------------------------------	---	--

This parameter is used to set up the communication whether to change the run command source.

6.16 P28 Status Monitoring Parameter Group

P28.00	Running Frequency		0.01Hz	●
P28.01	Setting Frequency		0.01Hz	●
P28.02	Slop Given Frequency		0.01Hz	●
P28.03	Bus Voltage		0.1V	●
P28.04	Output Voltage		1V	●
P28.05	Output Current		0.1A	●
P28.06	Torque Current		0.1A	●
P28.07	Excitation Current		0.1A	●
P28.08	Output Power Percent		0.1%	●
P28.09	Output Torque		0.1Nm	●
P28.10	Output Torque Percent		0.1%	●
P28.11	Set Torque Percent		0.1%	●
P28.12	Motor Running RPM		1RPM	●
P28.13	Speed Controller Output		0.1%	●
P28.14	DI Input State		1	●
P28.15	DO Input State		1	●
P28.16	AI1 Voltage		0.01V	●
P28.19	Count Value		1	●
P28.20	Motor Power Factor		0.01	●
P28.21	Magnetic Linkage		0.1%	●

P28.22	PID Setting Value		0.1	●
P28.23	PID Feedback Value		0.1	●
P28.24	PID Output Value		0.1%	●
P28.27	Current Fault Code		0	●
P28.28	Accumulative Running Time		1h	●
P28.00	Running Frequency		0.01Hz	●
P28.01	Setting Frequency		0.01Hz	●
P28.02	Slop Given Frequency		0.01Hz	●
P28.03	Bus Voltage		0.1V	●
P28.04	Output Voltage		1V	●
P28.05	Output Current		0.1A	●
P28.06	Torque Current		0.1A	●
P28.07	Excitation Current		0.1A	●
P28.08	Output Power Percent		0.1%	●
P28.09	Output Torque		0.1Nm	●
P28.10	Output Torque Percent		0.1%	●
P28.11	Set Torque Percent		0.1%	●

The above parameters are used to check the inverter input, output, and other users to set the real-time display of function value. Users may have the group function code real-time view, judge the run state of transducer.

6.17 P29 User Parameter Group

P29.00	User Password	0~65535	0	○
--------	---------------	---------	---	---

Any non-zero number can be set, and then the password protection function will be enabled.

When enter the menu next time, must input password correctly, otherwise can't view and modify the function parameters, please remember setup user password correctly.

Set P29.00 to 0000: Clear the previous setup user password and disable the password protection function.

P29.01	Parameter Initialization	0: No operation 1: Restore factory default setup value 2: Clear the fault record 3: Clear accumulative running and power-on time	0	◎
--------	--------------------------	---	---	---

recover manufacturer parameter: inverter function parameter mostly is recovered to manufacturer parameter, but motor parameter, error record message, accumulate run time, accumulate power-on time are not recovered.

clear error record: clear inverter error record message

clear accumulate run and power-on time: used to clear accumulate run and power-on time of inverter record.

P29.02	Product type	0~65535	Factory Setting	●
P29.03	Software version	1.00~10.00	Factory Setting	●
P29.04	Inverter rated power	0.4kW ~1000.0kW	Factory Setting	●
P29.05	Inverter Rated Voltage	220V~1140V	Factory Setting	●
P29.06	Inverter Rated Current	2.4A~2000.0A	Factory Setting	●
P29.07	Ex Factory Date (year/month)		Factory Setting	☆
P29.08	Ex Factory Date (day)		Factory Setting	☆
P29.09	Factory Use			☆
P29.10	Factory Use			☆
P29.11	Factory Use			☆

Above parameter is used to check over inverter manufacturer setting and inverter critical parameter, only for user to review.

Chapter 7 Communication Protocol

VD100 series of inverter provides RS485 communication interface, and adopts Modbus-RTU communication protocol. User can carry out centralized control via PC/PLC or HOST computer to meet specified application requirements, such as setup inverter control command, running frequency, related function code parameter changes, inverter working condition and error information monitoring etc.

7.1 About Protocol

This Modbus serial communication protocol defines the frame content of asynchronous transmission information and use format in the series communication and it includes master-polling (or broadcast address) executive command, data and error checking. The response of slave is the same structure, and it includes action confirmation, returning the data and error checking etc. If slave takes place the error while it is receiving the information or cannot finish the action demanded by master, it will send one fault signal to master as a response.

7.2 Application Methods

VD100 series inverter can be connected with a “Single-master Multi-slave” control network with RS485 bus.

7.3 Bus Structure

(1) Interface mode: RS485 Hardware interface.

(2) Transmission mode:

There provide asynchronous series and half-duplex transmission mode. At the same time, just one can send the data and the other only receives the data between master and slave. In the series asynchronous communication, the data is sent out frame by frame in the form of message.

(3) Topological mode:

In Single-master system, the setup range of slave address is 0 to 247. Zero refers to broadcast communication address. The address of slave must is exclusive in the network. That is the basis to guarantee the Modbus serial communication.

7.4 Communication Protocol Introduction

VD100 series inverter communication protocol is a kind of serial master-slave communication protocol, in the network, only one equipment (master) can build a protocol, (Named as “Inquire/Command”). Other equipment (slave) only by providing the data response “Inquire/Command” or doing the action according to the master’s “Inquiry/Command”. Here, master is personnel computer (PC), industrial control machine or programmable logical controller(PLC) etc., and the slave is inverter. Master not only visits some slave, but also sends the broadcast information to all the slaves. For the single master “Inquiry/Command”, all of slaves will return a signal that is a response; for the broadcast information provided by master, slave needs not feedback a response to master machine.

7.5 Communication Frame Structure

There is RTU mode in the communication data transfer mode of VD100 MODBUS protocol.

In RTU mode, format of every byte as below:

Code system: 8bit of binary, in every 8bit frame field, including 2 hexadecimal characters, hexadecimal 0~9, A~F.

Data format: start bit, 8bit of data, check bit, stop bit. Data format description as following table: in RTU mode, new format is always started with 3.5bits' transmitting time silence. In network with baud rate calculated transmitting rate, 3.5bits' transmitting time is easily controlled. Following the transmitting data field is sequence as : slave address, operating command code, data, CRC check bit, every field transmit bit is hexadecimal 0...9, A...F. Network device always monitor communication bus. When receiving the 1st field (address message), every network device will confirm this bit, followed by the last bit transmitting completed, another similar 3.5 bit transmitting time interval to express the end of this format. Thereafter, a new format transmitting will be started.

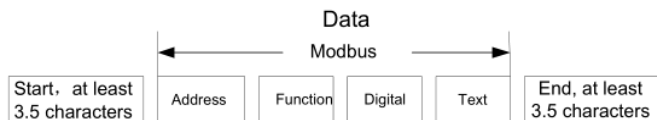

One format of message must be transmitted via a continuous data flow, if there is an interval of 3.5 bytes or above before the complete format transmitting completed, Receiving device will clear this uncompleted message, and mistakenly consider the following byte is an address field of a new format. Same way, if the interval less than 3.5 bytes between the start of a new format and the previous format, the receiving device will consider it as a continue of the previous format. Due to the confusing of format, the final CRC check value is not correct and can result in communication error.

RTU format standard structure:

Frame header START	T1-T2-T3-T4 (3.5 bits transmission time)
Slave address field ADDR	Communication address: 0~247 (decimal) (0 as broadcast address)
Function field CMD	03H: read slave parameter 06H: write slave parameter
Data field DATA (N-1)...DATA (0)	2*N bit data: this part is the main content of communication, also as the core of data exchange in communication
CRC CHK low bit	Detect value: CRC verify bit (16bit)
CRC CHK high bit	
Frame footer END	T1-T2-T3-T4 (3.5 bits transmission time)
END Lo	

7.6 Command Code and Communication Data Description

7.6.1 Command code: 03H (0000 0011), read N byte (word) (can read continuously 16bytes)

For example: inverter slave address as 01H, RAM starting address as 3200H (communication read output frequency address), read continuous 1 byte, then this format structure description as below:

RTU MASTER COMMAND MESSAGE

START	T1-T2-T3-T4
ADDR	01H
CMD	03H
START ADDRESS HIGH BIT	32H
START ADDRESS LOW BIT	00H
HIGH BIT OF DATA NUMBER	00H
LOW BIT OF DATA NUMBER	01H
CRC CHK LOW BIT	8AH
CRC CHK HIGH BIT	B2H
END	T1-T2-T3-T4

RTU SLAVE RESPONSE MESSAGE

START	T1-T2-T3-T4
ADDR	01H
CMD	03H
BYTE NUMBER	02H
DATA ADDR 0007H HIGH BIT	00H
DATA ADDR 0007H LOW BIT	00H
CRC CHK LOW BIT	8AH
CRC CHK HIGH BIT	B2H
END	T1-T2-T3-T4

7.6.2 Command Code: 06H (0000 0110), write one word (Word)

For example, write 5000 (1388H) to slave address 01H of inverter 3001H (communication setup frequency address), the frame structure is as below:

RTU MASTER COMMAND MESSAGE

START	T1-T2-T3-T4
ADDR	01H
CMD	06H
WRITE DATA ADDR HIGH BIT	30H
WRITE DATA ADDR LOW BIT	01H
DATA CONTENT HIGH BIT	13H
DATA CONTENT LOW BIT	88H
CRC CHK LOW BIT	DAH
CRC CHK HIGH BIT	5CH
END	T1-T2-T3-T4

RTU SLAVE RESPONSE MESSAGE

START	T1-T2-T3-T4
ADDR	01H
CMD	06H
WRITE DATA ADDR HIGH BIT	00H
WRITE DATA ADDR LOW BIT	0BH
DATA CONTENT HIGH BIT	13H
DATA CONTENT LOW BIT	88H
CRC CHK LOW BIT	DAH
CRC CHK HIGH BIT	5CH
END	T1-T2-T3-T4

7.6.3 Communication Format Error Check Method

Format error check method including 2 part check, that is bit digit check (odd/even check) and the complete data CRC check of format.

7.6.3.1 Byte check

User can select different bit check mode, also can select no check, this can affect check bit setup of each byte.

The definition of even checkout: add an even check bit before the data transmission to illustrate the number of "1" in the data transmission is odd number or even number. When it is even, the check byte is "0"; otherwise, the check byte is "1". This method is used to stabilize the parity of the data.

The definition of odd checkout: add an odd check bit before the data transmission to illustrate the number of "1" in the data transmission is odd number or even number. When it is odd, the check byte is "0", otherwise, the check byte is "1". This method is used to stabilize the parity of the data.

For example, when transmitting "11001110", there are five "1" in the data. If the even checkout is applied, the even check bit is "1"; if the odd checkout is applied; the odd check bit is "0". The even and odd check bit is calculated on the check bit position of the frame. And the receiving devices also carry out even and odd checkout. If the parity of the receiving data is different from the setting value, there is an error in the communication.

6.6.3.2 CRC check method:

The checkout uses RTU frame format. The frame includes the frame error detection field which is based on the CRC calculation method. The CRC field is two bytes, including 16 figure binary values. It is added into the frame after calculated by transmitting device. The receiving device recalculates the CRC of the received frame and compares them with the value in the received CRC field. If the two CRC values are different, there is an error in the communication.

During CRC, 0*FFFF will be stored. And then, deal with the continuous 6-above bytes in the frame and the value in the register. Only the 8Bit data in every character is effective to CRC, while the start bit, the end and the odd and even check bit is ineffective.

In CRC producing process, every 8bit byte is individually XOR with content of register, results moves toward the lowest effective bit, the highest effective bit is filled with 0. LSB is taken out to be checked, if LSB is 1, register is individually do XOR with preset value, if LSB is 0, then no action required. The whole process needs to be repeated for 8times. After the last bit (the 8th bit) is completed, a next byte with 8bits will do XOR with present value of register individually. The final value of register, is CRC value after all bytes executed of frames.

The calculation of CRC applies the international standard CRC checkout principles. When the user is editing CRC calculation, he can refer to the relative standard CRC calculation to write the required CRC calculation program.

Here provided a simple function of CRC calculation for the reference (programmed with C language):

```
unsigned int crc_cal_value (unsigned char *data_value,unsigned char data_length)
unsigned int crc_cal_value (unsigned char *data_value,   unsigned char data_length)
{
int i;
unsigned int crc_value=0xffff;   while (data_length--)
{
crc_value^=*data_value++;
for (i=0; i<8; i++)
{
if (crc_value&0x0001)
```

```

crc_value= (crc_value>>1)^0xa001;
else
crc_value=crc_value>>1;
}
}
return (crc_value);
}

```

In ladder logic, CKSM calculated the CRC value according to the frame with the table inquiry. The method is advanced with easy program and quick calculation speed. But the ROM space the program occupied is huge. So use it with caution according to the program required space.

7.6.4 The Definition of Data Address

The address definition of the communication data in this part is to control the running of the inverter and get the state information and relative function parameters of the inverter.

① The rules of parameter address of the function codes

The function codes sequence as a parameter corresponding with register address, but if converted into hexadecimal, such as hexadecimal communication address 050BH of parameter P05.11, hexadecimal communication address 0D16H of parameter P13.22

Note: P30 group is manufacturer setup parameter, which cannot be read nor changed. Some parameters cannot be changed while inverter operating, some cannot be changed in whatever conditions. To change function code parameter, please take care of the setup range, unit and related explaining.

In addition, since EEPROM is saved frequently, this can reduce the life of EEPROM, for users, some function code under communication mode do need to be saved, only required to change RAM value inside it to meet user requirement. In order to realize this function, the corresponding function code high bit address add with 80H (hexadecimal expresses 64) is to realized. Such as write function code P11.02 need to be saved to EEPROM, the address set as 0B02H, if only need to change RAM value, no need to save to EEPROM, can set address as 8B02H, this address only used in writing RAM, not in read function, reading this address is Disabled.

② Other function address explaining:

Function	Address Definition	Date Description	R/W Property
Communication Control Order	30000H	0.01H: Forward rotation	R/W
		0.002H: Reverse rotation	
		0.003H: Stop	
		0.004H: Coast to stop	
		0.005H: Fault reset	

		0.006H: Forward jog		
		0.007H: Reverse jog		
		0.008H: Jog stop		
		0.009H: Emergency stop		
Communication Set Value Address	3001H	Communication set frequency (0~P0.07, Unit: 0.01Hz)	R/W	
	3002H	Torque set value (-3000~3000, 1000 corresponding to 100.0% motor rated current)		
	3003H	The upper limit torque of motor torque (0~3000, 1000 corresponding to 100% inverter motor current)		
	3004H	Braking torque upper limit torque (0~3000, 1000 corresponding to 100% motor rated current)		
	3005H	The upper limit frequency set value of forward rotation (0~P00.07, Unit: 0.01Hz)		
	3006H	The upper limit frequency set value of reverse rotation (0~P00.07, Unit: 0.01Hz)		
	3007H	PID setting, range (0~1000, 1000 corresponding to 100%)		
	3008H	PID feedback, range (0~1000, 1000 corresponding to 100%)		
	3009H	Special control command byte		
		Bit		Value 0
Bit0、Bit1 =0		Reserved		
Bit2		No action	Torque control prohibit	
Bit3		No action	Pre-excitation	
	Bit4	No action	DC brake	

	300AH	Voltage set value (special for V/F separation use) (0~1000, 1000 corresponding to 100% motor rated current)			
	300BH	Virtual input terminal command, range: 0x00~0x1FF			
	300CH	Virtual output terminal command, range: 0x00~0x3			
	300DH	AO output set value 1 (-1000~1000, 1000 corresponding to 100%)			
	300EH	AO output set value 2 (-1000~1000, 1000 corresponding to 100%)			
	300FH	PID feed forward value (-1000~1000, 1000 corresponding to 100%)			
Inverter Status Byte 1	3100H	0001H: Forward rotation		R	
		0002H: Reverse rotation			
		0003H: Inverter stopping			
		0004H: Inverter at fault			
		0005H: Inverter at POFF state			
		0006H: Inverter at Pre-excitation state			
Inverter Status Byte 2	3101H	Special control command byte		W	
		Bit	0		1
		Bit0, Bit1	Reserved		
		Bit2	Ready for running		Ready for running
		Bit3	Motor with no excitation		Motor with excitation
		Bit4	Un-overload pre-alarm		overload pre-alarm
Error Code	3102H	Refer to error type description		R	
Product Code	3103H			R	
Motor Running Frequency	3200H	0.00Hz~P00.07		R	

Set Frequency	3201H	0.00Hz~P00.07	R
Motor Running Speed	3202H	0RPM~65535RPM	R
BUS Voltage	3203H	0.0V~2000.0V	R
Output Current	3204H	0.0A~2000.0A	R
Output Voltage	3205H	0V~1200V	R
Setting Torque	3206H	-250.0%~250.0%	R
Output Torque	3207H	-250.0%~250.0%	R
Output Power	3208H	-300.0%~300.0%	R
Input Terminal State	3209H	0x0000~0x003F	R
Output Terminal State	320AH	0x0000~0x0003	R
PID Set value	320BH	-100.0%~100.0%	R
PID Feedback Value	320CH	-100.0%~100.0%	R
AI1 Input Value	320DH	0.00V~10.00V	R
Reserved	320EH		R
Reserved	320FH		R
Count Value	3210H	0~65525	R
Count Value	3211H	0~65535	R
MS Speed Present Stage	3212H	0~15	R
Password Verify	4000H	0~65535	W

7.6.5 Inverter Response when Communication Fail

In communication control, if communication operation command is in discrepancy (such as read-only address to deal with write operation command), or communication operating address is in discrepancy (such as the address is not existed or the address doesn't enabled user operating); or operand is in discrepancy (such as operand exceeding the setting range or operation communication continuously reading, inverter continuous address quantity less than communication read of address number). At this stage, inverter will return error message to HOST pc on real-time for reminding communication error.

While inverter responding HOST PC, it use function code and error code to indicate whether communication operation is normal or occurred error. For normal response,

inverter return a corresponding function code and data address or sub-function code; for un-normal response of communication operation, the normal operation code with the high bit returned from inverter was set as 1: such as read command 03H, un-normal response is 83H, write command is 06H with its un-normal response as 86H. It followed error message code and CRC check code.

Communication error code is returned by inverter to the HOST PC, its code and meaning as below table:

Code	Description	Meaning
01H	Illegal command	Command sent is illegal
02H	Illegal data address	The register address sent to inverter is illegal or un-defined
03H	Illegal data value	Inverter received data value exceeding permitted range
04H	Operation failure	Setting parameter in write operation is Disabled setting
05H	Password error	User password checking is not pass
06H	Data frame error	The frame message sent from HOST pc, the length of data frame is not correct, or RTU format CRC checking error.
07H	Parameter read only	Write operation for read-only parameter
08H	Parameter run and cannot be changed	HOST pc change the parameters which cannot be changed when inverter is run.
09H	Password protection	HOST pc is reading or writing without password unlock.

While communication controlling inverter, if communication operation is normal, inverter returned data are in sequence as inverter communication address, operation command word, parameter address, parameter data and CRC check. Such as 3000H of write 01 inverter address, write-in data is 1, so communication command is 010630000001470A. So at the status inverter returned data is 010630000001470A.

If rewrite data is 09H, and communication command is 01063000000946CC, at this status inverter returned data is 01860443A3. Its returned data 86H stands for wrong

rewrite command, 04H is communication error code expressing operation failure. Since for 3000H address, the max write-in number is 08H, exceeding its setting range.

9.6.6 Continuous Communication Data Address Parameter Read Description

VD100 series inverter supports max 16 numbers continuous address parameter data reading, communication reading only need randomly designating starting address and the data byte numbers from starting address. Such as reading motor run frequency when inverter is run, reading motor run speed, output current, then communication parameter starting address is 3200H, reading data byte number is 0005H, inverter returned run data numbered 1, 3, 5 in sequence as motor run frequency, motor running speed, output current.

Communication Address	Corresponding Parameter Serial Number	Parameter Range	R/W Property
Motor run frequency	3200H	0.00Hz~P00.07	R
Set frequency	3201H	0.00Hz~P00.07	R
Motor run speed	3202H	0RPM~65535RPM	R
Bus voltage	3203H	0.0V~2000.0V	R
Output current	3204H	0.0A~2000.0A	R
Output voltage	3205H	0V~1200V	R
Reserved	3206H		R
Output torque	3207H	-250.0%~250.0%	R
Output power	3208H	-300.0%~300.0%	R
Input terminal state	3209H	0X0000~0X003F	R
Output terminal state	320AH	0X0000~0X0003	R
PID set value	320BH	-100.0%~100.0%	R
PID feedback value	320CH	-100.0%~100.0%	R
AI1 input value	320DH	0.00V~10.00V	R
Reserved	320EH		R
Reserved	320FH		R
Count value	3210H	0~65535	R
MS speed present stage	3211H	0~15	R

Chapter 8 Trouble Shooting

8.1 Error Alarm and Solution

VD100 inverter has warning information and fault protection function. In case of abnormal fault, the inverter error relay contactor will be in action, before user seeking for help, please do self-inspection according to this chapter to analyze causes and find out solution. If user cannot solve problem by himself, seeking for help or directly contact your local dealer or our company.

VD100 inverter during running process or powered on, if fault occurred, on the display of panel of inverter will show error code. At the moment inverter already have protection effectively to the fault, output terminal stopped output, the display panel has indicating current error with 2~5 code.

Inverter keypad displayer has showing error code when in error, the code content and corrective action as below table.

Code	Error Type	Possible Error Causes	Solution
Er001	Acceleration run over-current (hardware)	1: Acceleration time is too short 2: Motor parameter is not correct 3: Grid voltage is too low 4: Inverter power is too small 5: V/F curve inappropriate 6: Inverse module short circuit protection	1: Extend acceleration time 2: Self-tuning of motor parameter 3: Check grid input power 4: Select inverter with bigger power class 5: Adjust V/F curve setting, adjust manual torque boost 6: Inverter module or drive circuit damage
Er002	Deceleration run over-current (hardware)	1: Deceleration time is too short 2: load inertia torque is too big 3: Inverter power is too small 4: Inverse module short circuit protection	1: Extend deceleration time 2: Add external energy consumption braking unit 3: Choose inverter with bigger class power 4: Inverse module or drive circuit damage
Er003	Constant speed run over-current (hardware)	1: Load with jump or abnormal 2: Grid voltage is too low 3: Inverter power is too small 4: Inverse module short circuit protection	1: Check load or reduce load jumping 2: Check grid input power 3: Choose inverter with bigger class power 4: Inverse module or drive circuit damage

Er004	Acceleration run over-current (software)	<ol style="list-style-type: none"> 1: Acceleration time is too short 2: Motor parameter is not correct 3: Grid voltage is too low 4: Inverter power is too small 5: V/F curve inappropriate 	<ol style="list-style-type: none"> 1: Extend acceleration time 2: Self-tuning of motor parameter 3: Check grid input power 4: Select inverter with bigger power class 5: Adjust V/F curve setting, adjust manual torque boost
Er005	Deceleration run over-current (software)	<ol style="list-style-type: none"> 1: Deceleration time is too short 2: Load inertia torque is too big 3: Inverter power is too small 	<ol style="list-style-type: none"> 1: Extend deceleration time 2: Add external energy consumption braking unit 3: Choose inverter with bigger class power
Er006	Constant speed run over-current (software)	<ol style="list-style-type: none"> 1: Load with jump or abnormal 2: Grid voltage is too low 3: Inverter power is too small 	<ol style="list-style-type: none"> 1: Check load or reduce load jumping 2: Check grid input power 3: Choose inverter with bigger class power
Er007	Acceleration run over-voltage	<ol style="list-style-type: none"> 1: Input voltage abnormal 2: Restart motor in rotating after instant power off 	<ol style="list-style-type: none"> 1: Check grid input power 2: Avoid stop and restart
Er008	Deceleration run over-voltage	<ol style="list-style-type: none"> 1: Deceleration time is too short 2: Load inertia torque is too big 3: Input voltage abnormal 	<ol style="list-style-type: none"> 1: Extend Deceleration time 2: Increase energy consumption braking unit 3: Check grid input power
Er009	Constant speed run over-voltage	<ol style="list-style-type: none"> 1: Input voltage abnormal 2: Input voltage with abnormal change 3: Load inertia is too big 	<ol style="list-style-type: none"> 1: Check grid input power 2: Install input electric reactor 3: Add external energy consumption braking unit
Er010	Bus under-voltage	<ol style="list-style-type: none"> 1: Grid voltage too low 2: Instant power off 	<ol style="list-style-type: none"> 1: Check grid input power 2: RESET operation
Er011	Motor	<ol style="list-style-type: none"> 1: Grid voltage is too low 	<ol style="list-style-type: none"> 1: Check grid voltage

	overload	2: Motor rate current setting un-correct 3: Motor stalled for load jump is too big	2: Reset setting motor rate current 3: Check load, adjust torque boost quantity
Er012	Inverter overload	1: Acceleration is too quick 2: Restart motor in rotating 3: Grid voltage is too low 4: Load is too big	1: Increase acceleration time 2: Avoid stop and restart 3: Check grid voltage 4: Choose bigger power inverter
Er013	Phase loss at input side	Phase loss with input R, S, T	1: Check grid input power 2: Check installation wiring
Er014	Phase loss at output side	1: U, V, W output phase loss 2: Load 3phase seriously unbalance	1: Check output wiring 2: Check motor and cable
Er015	Inverse module overheat	1: Inverter instant over current 2: Output 3phase with interphase or short circuit to ground 3: Air channel stalled or fan damaged 4: Environment temperature high 5: Control board connection or plug in loose 6: Auxiliary power damage, drive voltage under-voltage 7: Power module with bridge arm straight 8: Control board abnormal	1: Refer to overcurrent solution 2: Re-wiring 3: Clear fan channel or change fan 4: Reduce environment temperature 5: Check and re-connect 6: Seek for help 7: Seek for help 8: Seek for help
Er016	Current over limit error in run	Setting of Current over limit value is small	Check P13.09~P13.11 setting
Er017	External error	DI external error input terminal act	Check external device input

Er018	Communication error	<ol style="list-style-type: none"> 1: Baud rate setting inappropriate 2: Adopt serious communication error 3: Communication break up for long time 	<ol style="list-style-type: none"> 1: Set appropriate baud rate 2: Press STOP/RST key to reset, seek help 3: Check communication interface wiring
Er019	Current detecting circuit error	<ol style="list-style-type: none"> 1: Control board connector with bad connection 2: Auxiliary power damage 3: Hall device damage 4: Amplify circuit abnormal 	<ol style="list-style-type: none"> 1: Check connector, re-wiring 2: Seek for help 3: Seek for help 4: Seek for help
Er020	Motor self-learning error	<ol style="list-style-type: none"> 1: Motor and inverter capacity is not match 2: Motor rate parameter setting inappropriate 3: Self-learning parameter and standard parameter deviation is too big 4: Self-learning overtime 	<ol style="list-style-type: none"> 1: Change inverter model 2: Set rate parameter according to motor nameplate 3: Make motor empty load, re-identify 4: Check motor wire connection, parameter setting
Er021	EEPROM write-read error	<ol style="list-style-type: none"> 1: Write-read error of the control parameter 2: EEPROM damage 	<ol style="list-style-type: none"> 1: Press STOP/RST key to reset, seek for help 2: Seek for help
Er022	PID feedback over limit error in run	Feedback exceeding setting upper limit	Check if feedback source device is abnormal
Er023	PID feedback break line error	<ol style="list-style-type: none"> 1: PID feedback break line 2: PID feedback source lost 	<ol style="list-style-type: none"> 1: Check PID feedback signal 2: Check PID feedback source
Er024	Motor short circuit to ground	One phase short circuit to ground (U, V, W)	Check output 3phase to ground conductance, eliminate error
Er027	Run time arrival	Setting run time arrival	Use parameter initial function to clear record message
Er028	Power-on	Set up power-on time	Use parameter initial function

	time arrival	arrival	to clear record message
Er029	Offload	Inverter run current is smaller than setting value	Confirm if load has broken away or parameter setting is appropriate for actual condition
Er034	Motor overheat	1: Temperature sensor connection loosen 2: Motor temperature high	1: Check temperature sensor connection and eliminate error 2: Reduce carrier or take other measurement to cool down motor
Er036	Electronic overload	Inverter take overload protection according to set value	1: Check load 2: Reset overload pre-alarm parameter
Er041	User self-define error 1	User self-define error 1 signal input terminal enabled	1: Check the signal source 2: Eliminate signal action source
Er060	Manufacturer self-define Error 1	Manufacturer inside use error code	Seek for help
Er061	Manufacturer self-define Error 2	Manufacturer inside use error code	Seek for help

8.2 Common Faults and Solutions

8.2.1 No Display after Power on

Use multi-meter to check inverter input power to see if it is in accordance with inverter rated voltage. If power voltage factor is eliminated, then check 3phase rectifier bridge is okay. If rectifier bridge has exploded, please ask for help.

8.2.2 Power air switch tripping-off after power-on

Check if there is a grounding connection or short-circuit somewhere of the input power, then eliminate existed problem. Check if rectifier bridge has been broken down, if it is damaged, ask for help.

8.2.3 Motor doesn't rotate after inverter running:

Check if there is balanced three-phase output among U, V, W. If yes, then motor could be damaged or motor control circuit or mechanical reason blocked. Please eliminate these. If the output is unbalanced or lost, the inverter drive board or the output module may be damaged, ask for support. If there is no output voltage, it could be the driving board or output module damaged.

8.2.4 Inverter display is normal when power-on, the power air-switch tripping off after inverter started

① check if there is short circuit among the output modules. If yes, ask for support.

-
- ② Check if there is ground fault or short circuit between the motor leading wire exists. If yes, solve it.
 - ③ If trip happens occasionally and the distance between motor and inverter is too far, it is recommended to install output AC reactor
 - ④ When inverter is under normal protection, after eliminating failure, can press STOP/RESET key to reset, then restart inverter.
 - ⑤ After failure solved, power off the inverter power supply, then power-on inverter after the LED lights all shut down, then restart inverter.
 - ⑥ If above measurements are all in vain to get inverter into normal usage, then take note of the error code of the displayer, the inverter specification and product code, to contact the manufacturer technician for help.



Warranty Agreement

1. The warranty period of the product is 18 months from date of manufacturing. During the warranty period, if the product fails or is damaged under the condition of normal use by following the instructions, Vicruns will be responsible for free maintenance.
2. Within the warranty period, maintenance will be charged for the damages caused by the following reasons:
 - A. Improper use or repair/modification without prior permission;
 - B. Fire, flood, abnormal voltage, other disasters and secondary disaster;
 - C. Hardware damage caused by dropping or transportation after procurement;
 - D. Improper operation;
 - E. Trouble out of the equipment (for example, external device).
3. If there is any failure or damage to the product, please correctly fill out the Product Warranty Card in detail.
4. The maintenance fee is charged according to the latest Maintenance Price List of Vicruns.
5. The product Warranty Card is not re-issued. Please keep the card and present it to the maintenance personnel when asking for maintenance.
6. If there is any problem during the service, contact Vicruns's agent of Vicruns directly.
7. This agreement shall be interpreted by Hunan Vicruns Electric Technology Co., Ltd.

Vicruns Electric (Shenzhen) Co., Ltd.

25th Building, Xili Industrial Zone, Xiangguang Road, Nanshan District, Shenzhen, China

Tel: +86-755-26638560 Fax: +86-755-26639560

Hunan Vicruns Electric Technology Co., Ltd.

No.36 Shuangma No.6 Road, High-Tech Zone, Xiangtan, Hunan, China

Tel: +86-731-58551858 Fax: +86-731-58551956

Email: export@vicruns.com Website: www.vicruns.com



Product Warranty Card

Customer Information	Address:	
	Company Name:	Contact Person:
	Postcode:	Tel of Email:
Product Information	Product Model:	
	Serial No:	
	Name of supplier who supplied you the unit:	
Failure Description (eg.Fault code)	Maintenance Personnel:	